



MODELS

FTXG-L (20/25/35/50).....	1
FTXJ-L (20/25/35/50)	
FTXM-M (20/25/35/42).....	3
ATXM-M (20/25/35)	
CTXM-M (15)	
FTXTM-M (30/40)	
FTXM-M (50/60/71).....	5
ATXM-M (50)	



FTXG-L (20/25/35/50), FTXJ-L (20/25/35/50)

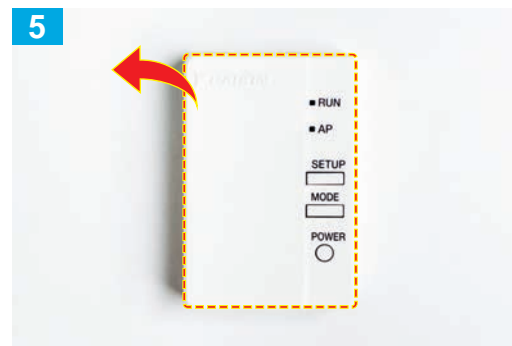
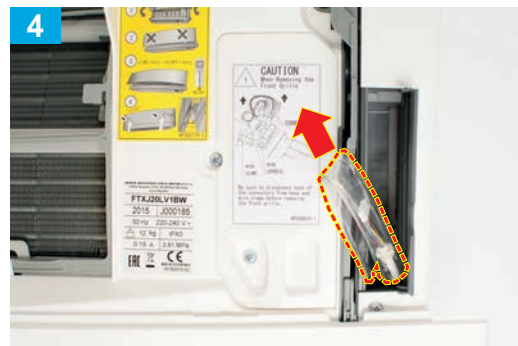
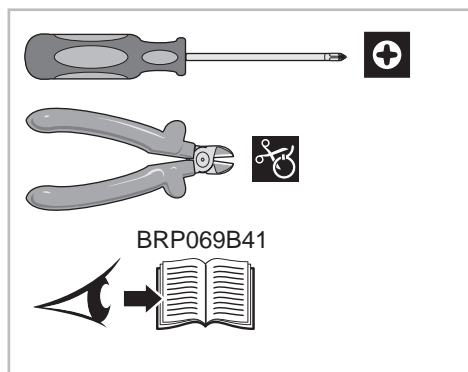
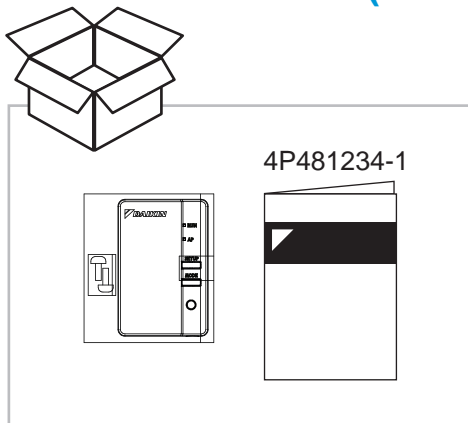



FTXG-L (20/25/35/50), FTXJ-L (20/25/35/50)

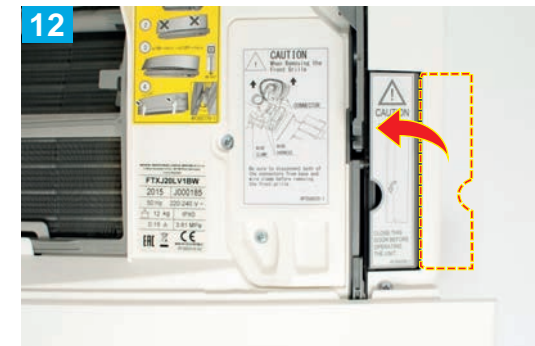
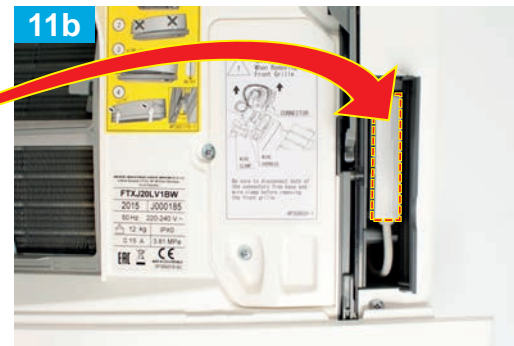
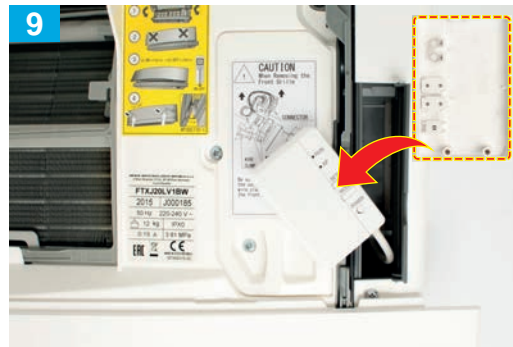



FTXM-M (20/25/35/42), ATXM-M (20/25/35), CTXM-M (15), FTXTM-M (30/40)

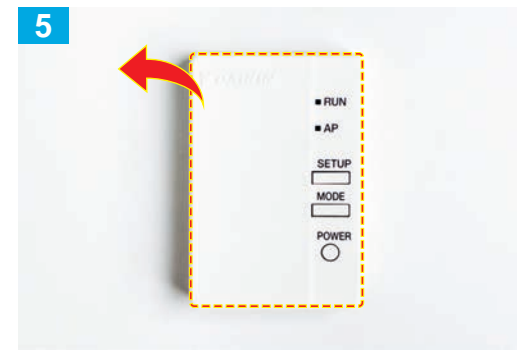
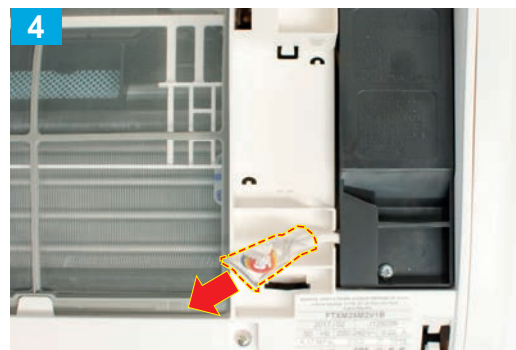
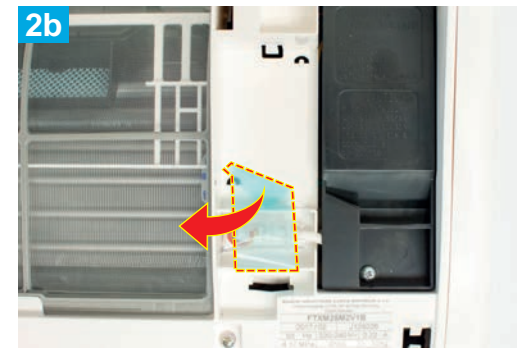
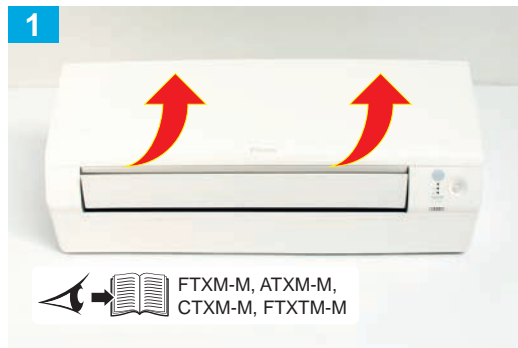
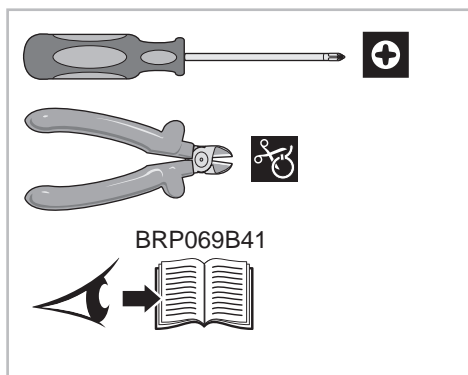
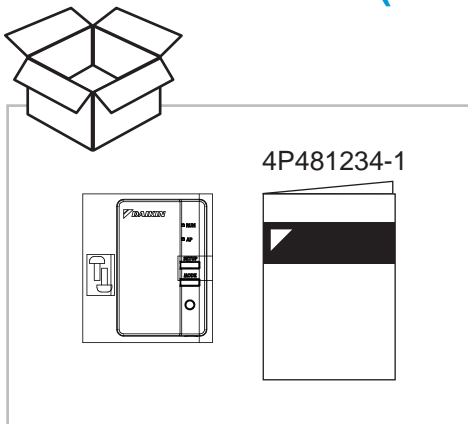



BRP069B41

FTXM-M (20/25/35/42), ATXM-M (20/25/35), CTXM-M (15), FTXTM-M (30/40)

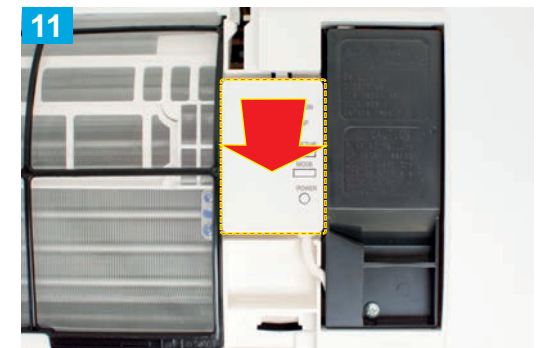
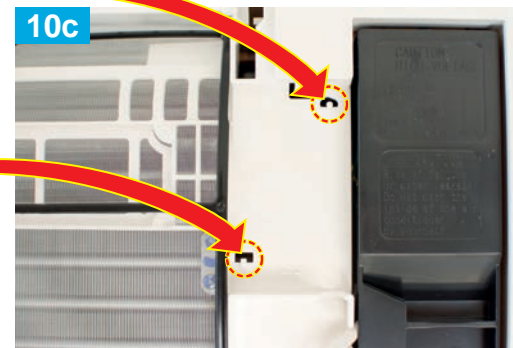
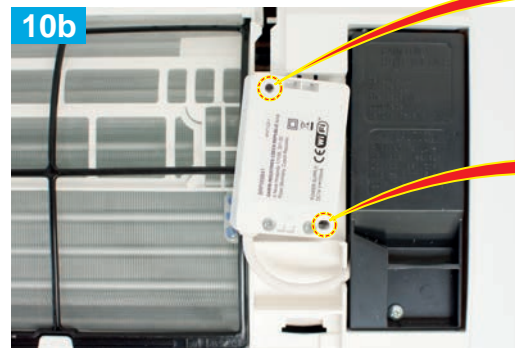



BRP069B41

FTXM-M (50/60/71), ATXM-M (50)

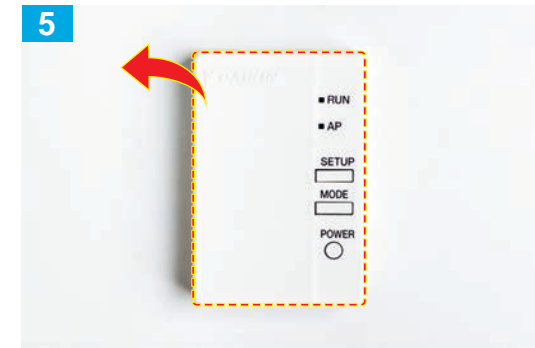
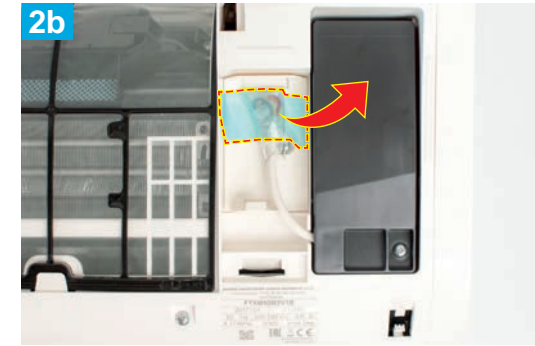
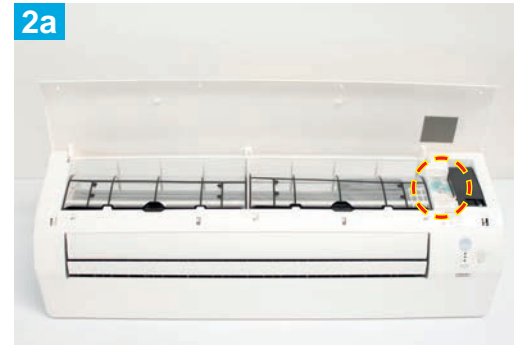
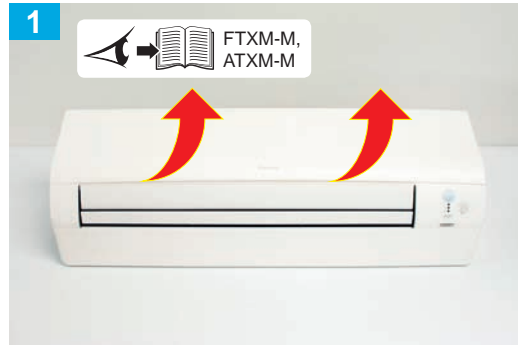
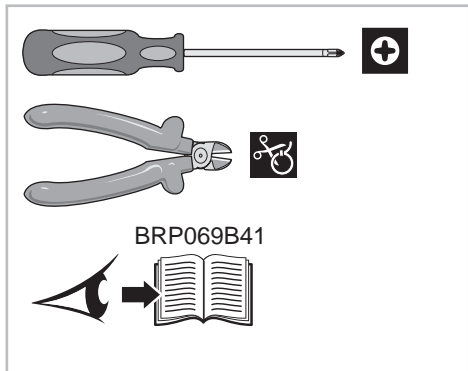
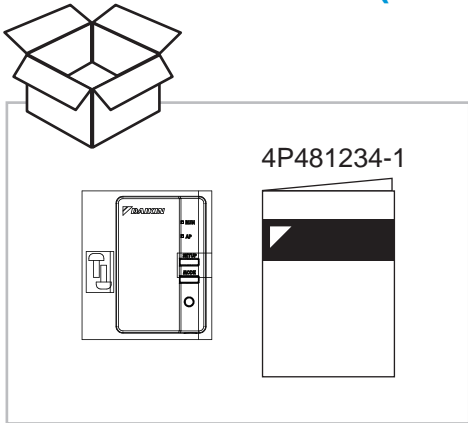



BRP069B41

FTXM-M (50/60/71), ATXM-M (50)

