

Revision G:

 • MXZ-2F33/42/53VF3 - **E2** and MXZ-2F53VFH3 - **E2**
 have been added.

OBH790 REVISED EDITION-F is void.

OUTDOOR UNIT

SERVICE MANUAL

**No. OBH790
REVISED EDITION-G**

Models

 MXZ-2F33VF - **E1**, **ET1**

 MXZ-2F33VF2 - **E1**, **ET1**

 MXZ-2F33VF3 - **E1**, **ET1**, **E2**

 MXZ-2F42VF - **E1**, **ET1**

 MXZ-2F42VF2 - **E1**, **ET1**

 MXZ-2F42VF3 - **E1**, **ET1**, **E2**

 MXZ-2F53VF - **E1**, **ET1**

 MXZ-2F53VF2 - **E1**, **ET1**

 MXZ-2F53VF3 - **E1**, **ET1**, **E2**

 MXZ-2F53VFH - **E1**

 MXZ-2F53VFH2 - **E1**

 MXZ-2F53VFH3 - **E1**, **E2**

 MXZ-3F54VF - **E1**, **ET1**, **E2**, **ET2**

 MXZ-3F54VF2 - **E1**, **ET1**

 MXZ-3F54VF3 - **E1**, **ET1**

 MXZ-3F68VF - **E1**, **ET1**, **E2**, **ET2**

 MXZ-3F68VF2 - **E1**, **ET1**

 MXZ-3F68VF3 - **E1**, **ET1**

 MXZ-4F72VF - **E1**, **ET1**, **E2**, **ET2**

 MXZ-4F72VF2 - **E1**, **ET1**

 MXZ-4F72VF3 - **E1**, **ET1**

 MXZ-4F80VF2 - **E1**, **ET1**

 MXZ-4F80VF3 - **E1**, **ET1**

 MXZ-4F83VF - **E1**, **ET1**

 MXZ-5F102VF - **E1**, **ET1**

 MXZ-6F122VF - **E1**, **ET1**

 MXZ-2F53VFHZ - **E1**

 MXZ-4F83VFHZ - **E1**
Indoor unit service manual

MSZ-LN•VG Series (OBH766) MLZ-KP•VF Series (OBH801)

MSZ-LN•VG2 Series (OBH766) MFZ-KT•VG Series (OBH843)

MSZ-EF•VG Series (OBH589) SLZ-M•FA Series (OCH522)

MSZ-AP•VF Series (OBH799) SEZ-M•DA Series (HWE17040)

MSZ-AP•VG Series (OBH788) PCA-M•KA Series (OCH659)

MSZ-BT•VG Series (OBH849) PEAD-M•JA(L) Series (HWE16130)

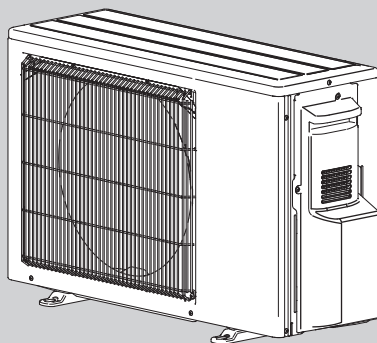

MXZ-2F33VF	MXZ-2F33VF2	MXZ-2F33VF3
MXZ-2F42VF	MXZ-2F42VF2	MXZ-2F42VF3
MXZ-2F53VF	MXZ-2F53VF2	MXZ-2F53VF3
MXZ-2F53VFH	MXZ-2F53VFH2	MXZ-2F53VFH3

CONTENTS

• INDOOR / OUTDOOR UNIT COMPATIBILITY TABLE	4
1. TECHNICAL CHANGES	6
2. SAFETY PRECAUTION	7
3. PART NAMES AND FUNCTIONS	17
4. SPECIFICATION	19
5. NOISE CRITERIA CURVES	44
6. OUTLINES AND DIMENSIONS	48
7. WIRING DIAGRAM	56
8. REFRIGERANT SYSTEM DIAGRAM	82
9. PERFORMANCE CURVES.....	93
10. ACTUATOR CONTROL	142
11. SERVICE FUNCTIONS	143
12. TROUBLESHOOTING	150
13. DISASSEMBLY INSTRUCTIONS.....	184

PARTS CATALOG (OBB790)

Revision A:

- MXZ-3F54VF - [E2], [ET2], MXZ-3F68VF - [E2], [ET2] and MXZ-4F72VF - [E2], [ET2] have been added.

Revision B:

- MXZ-3F54VF2 - [E1], [ET1], MXZ-3F68VF2- [E1], [ET1], MXZ-4F72VF2 - [E1], [ET1] and MXZ-4F80VF2 - [E1], [ET1] have been added.

Revision C:

- MXZ-2F33VF2 - [E1], [ET1], MXZ-2F42VF2 - [E1], [ET1], MXZ-2F53VF2 - [E1], [ET1] and MXZ-2F53VFH2 - [E1] have been added.

Revision D:

- MXZ-2F33VF3 - [E1], [ET1], MXZ-2F42VF3 - [E1], [ET1], MXZ-2F53VF3 - [E1], [ET1], MXZ-2F53VFH3- [E1], MXZ-3F54VF3 - [E1], [ET1], MXZ-3F68VF3 - [E1], [ET1], MXZ-4F72VF3 - [E1], [ET1] and MXZ-4F80VF3- [E1], [ET1] have been added.

Revision E:

- MXZ-4F83VF - [E1], [ET1], MXZ-5F102VF - [E1], [ET1], MXZ-6F122VF - [E1], [ET1], MXZ-2F53VFHZ - [E1] and MXZ-4F83VFHZ - [E1] have been added.

Revision F:

- Chart of heating capacity and total input for MXZ-4F83VFHZ - [E1] have been added.
- Outdoor unit power supply for MXZ-4F83VF - [ET1] and MXZ-5F102VF - [ET1] have been added.

Revision G:

- MXZ-2F33/42/53VF3 - [E2] and MXZ-2F53VFH3 - [E2] have been added.

Use the specified refrigerant only

Never use any refrigerant other than that specified.

Doing so may cause a burst, an explosion, or fire when the unit is being used, serviced, or disposed of.

Correct refrigerant is specified in the manuals and on the spec labels provided with our products.

We will not be held responsible for mechanical failure, system malfunction, unit breakdown or accidents caused by failure to follow the instructions.

<Preparation before the repair service>

- Prepare the proper tools.
- Prepare the proper protectors.
- Provide adequate ventilation.
- After stopping the operation of the air conditioner, turn off the power-supply breaker and remove the power plug.
- Discharge the capacitor before the work involving the electric parts.

<Precautions during the repair service>

- Do not perform the work involving the electric parts with wet hands.
- Do not pour water into the electric parts.
- Do not touch the refrigerant.
- Do not touch the hot or cold areas in the refrigeration cycle.
- When the repair or the inspection of the circuit needs to be done without turning off the power, exercise great caution not to touch the live parts.

⚠ WARNING

When the refrigeration circuit has a leak, do not execute pump down with the compressor.

When pumping down the refrigerant, stop the compressor before disconnecting the refrigerant pipes. The compressor may burst if air etc. get into it.

INDOOR / OUTDOOR UNIT COMPATIBILITY TABLE

<MXZ-2F33VF>

Connectable indoor unit lineups(Heat pump inverter type)		Capacity class [kW/h]									
Model type	Model name	15	18	20	22	25	35	42	50	60	71
Wall mounted	MSZ-LN**VG	●									
	MSZ-EF**VE3	●									
	MSZ-AP**VG	●									
	MSZ-AP**VF	●									
1way cassette	MLZ-KP**VF										
4way cassette	SLZ-M**FA										
Ceiling concealed	PEAD-M**JA(L)										
Ceiling suspended	SEZ-M**DA(L)										
Ceiling suspended	PCA-M**KA										

<MXZ-2F33VF2>

Connectable indoor unit lineups(Heat pump inverter type)		Capacity class [kW/h]									
Model type	Model name	15	18	20	22	25	35	42	50	60	71
Wall mounted	MSZ-LN**VG	●									
	MSZ-EF**VE3	●									
	MSZ-AP**VG	●									
	MSZ-AP**VF	●									
1way cassette	MLZ-KP**VF										
4way cassette	SLZ-M**FA										
Floor standing	MFZ-KT**VG										
Ceiling concealed	PEAD-M**JA(L)										
Ceiling suspended	SEZ-M**DA(L)										
Ceiling suspended	PCA-M**KA										

<MXZ-2F33VF3>

Connectable indoor unit lineups(Heat pump inverter type)		Capacity class [kW/h]									
Model type	Model name	15	18	20	22	25	35	42	50	60	71
Wall mounted	MSZ-LN**VG	●									
	MSZ-LN**VG2	●									
	MSZ-BT**VG	●									
	MSZ-EF**VE3	●									
	MSZ-EF**VG	●									
1way cassette	MLZ-KP**VF										
Floor standing	MFZ-KT**VG										
4way cassette	SLZ-M**FA										
Ceiling concealed	PEAD-M**JA(L)										
Ceiling suspended	SEZ-M**DA(L)										
Ceiling suspended	PCA-M**KA										

<MXZ-2F42VF>

Connectable indoor unit lineups(Heat pump inverter type)		Capacity class [kW/h]									
Model type	Model name	15	18	20	22	25	35	42	50	60	71
Wall mounted	MSZ-LN**VG	●									
	MSZ-EF**VE3	●									
	MSZ-AP**VG	●									
	MSZ-AP**VF	●									
1way cassette	MLZ-KP**VF										
4way cassette	SLZ-M**FA										
Ceiling concealed	PEAD-M**JA(L)										
Ceiling suspended	SEZ-M**DA(L)										
Ceiling suspended	PCA-M**KA										

<MXZ-2F42VF2>

Connectable indoor unit lineups(Heat pump inverter type)		Capacity class [kW/h]									
Model type	Model name	15	18	20	22	25	35	42	50	60	71
Wall mounted	MSZ-LN**VG	●									
	MSZ-EF**VE3	●									
	MSZ-AP**VG	●									
	MSZ-AP**VF	●									
1way cassette	MLZ-KP**VF										
4way cassette	SLZ-M**FA										
Floor standing	MFZ-KT**VG										
Ceiling concealed	PEAD-M**JA(L)										
Ceiling suspended	SEZ-M**DA(L)										
Ceiling suspended	PCA-M**KA										

<MXZ-2F42VF3>

Connectable indoor unit lineups(Heat pump inverter type)		Capacity class [kW/h]									
Model type	Model name	15	18	20	22	25	35	42	50	60	71
Wall mounted	MSZ-LN**VG	●									
	MSZ-LN**VG2	●									
	MSZ-BT**VG	●									
	MSZ-EF**VE3	●									
	MSZ-EF**VG	●									
1way cassette	MLZ-KP**VF										
Floor standing	MFZ-KT**VG										
4way cassette	SLZ-M**FA										
Ceiling concealed	PEAD-M**JA(L)										
Ceiling suspended	SEZ-M**DA(L)										
Ceiling suspended	PCA-M**KA										

<MXZ-2F53VF / MXZ-2F53VFH>

Connectable indoor unit lineups(Heat pump inverter type)		Capacity class [kW/h]									
Model type	Model name	15	18	20	22	25	35	42	50	60	71
Wall mounted	MSZ-LN**VG	●									
	MSZ-EF**VE3	●									
	MSZ-AP**VG	●									
	MSZ-AP**VF	●									
1way cassette	MLZ-KP**VF										
4way cassette	SLZ-M**FA										
Ceiling concealed	PEAD-M**JA(L)										
Ceiling suspended	SEZ-M**DA(L)										
Ceiling suspended	PCA-M**KA										

<MXZ-2F53VF2 / MXZ-2F53VFH2>

Connectable indoor unit lineups(Heat pump inverter type)		Capacity class [kW/h]									
Model type	Model name	15	18	20	22	25	35	42	50	60	71
Wall mounted	MSZ-LN**VG	●									
	MSZ-EF**VE3	●									
	MSZ-AP**VG	●									
	MSZ-AP**VF	●									
1way cassette	MLZ-KP**VF										
4way cassette	SLZ-M**FA										
Floor standing	MFZ-KT**VG										
Ceiling concealed	PEAD-M**JA(L)										
Ceiling suspended	SEZ-M**DA(L)										
Ceiling suspended	PCA-M**KA										

<MXZ-2F53VF3 / MXZ-2F53VFH3>

Connectable indoor unit lineups(Heat pump inverter type)		Capacity class [kW/h]									
Model type	Model name	15	18	20	22	25	35	42	50	60	71
Wall mounted	MSZ-LN**VG	●									
	MSZ-LN**VG2	●									
	MSZ-BT**VG	●									
	MSZ-EF**VE3	●									
	MSZ-EF**VG	●									
1way cassette	MLZ-KP**VF										
Floor standing	MFZ-KT**VG										
4way cassette	SLZ-M**FA										
Ceiling concealed	PEAD-M**JA(L)										
Ceiling suspended	SEZ-M**DA(L)										
Ceiling suspended	PCA-M**KA										

<MXZ-3F54VF>

Connectable indoor unit lineups(Heat pump inverter type)		Capacity class [kW/h]									
Model type	Model name	15	18	20	22	25	35	42	50	60	71
Wall mounted	MSZ-LN**VG	●									
	MSZ-LN**VG2	●									*
	MSZ-EF**VE3	●									
	MSZ-AP**VG	●									
1way cassette	MLZ-KP**VF										
4way cassette	SLZ-M**FA										
Ceiling concealed	PEAD-M**JA(L)										
Ceiling suspended	SEZ-M**DA(L)										
Ceiling suspended	PCA-M**KA										

*1: Models with service sub number -E2/ET2 are connectable.

<MXZ-3F54VF2>

Connectable indoor unit lineups(Heat pump inverter type)		Capacity class [kW/h]									
Model type	Model name	15	18	20	22	25	35	42	50	60	71
Wall mounted	MSZ-LN**VG	●									
	MSZ-LN**VG2	●									
	MSZ-EF**VE3	●									
	MSZ-AP**VG	●									
1way cassette	MLZ-KP**VF										
4way cassette	SLZ-M**FA										
Floor standing	MFZ-KT**VG										
Ceiling concealed	PEAD-M**JA(L)										
Ceiling suspended	SEZ-M**DA(L)										
Ceiling suspended	PCA-M**KA										

<MXZ-3F54VF3>

Connectable indoor unit lineups(Heat pump inverter type)		Capacity class [kW/h]									
Model type	Model name	15	18	20	22	25	35	42	50	60	71
Wall mounted	MSZ-LN**VG	●									
	MSZ-LN**VG2	●									
	MSZ-BT**VG	●									
	MSZ-EF**VE3	●									
	MSZ-EF**VG	●									
1way cassette	MLZ-KP**VF										
Floor standing	MFZ-KT**VG										
4way cassette	SLZ-M**FA										
Ceiling concealed	PEAD-M**JA(L)										
Ceiling suspended	SEZ-M**DA(L)										
Ceiling suspended	PCA-M**KA										

<MXZ-3F68VF / MXZ-4F72VF>

Connectable indoor unit lineups(Heat pump inverter type)		Capacity class [kW/h]									
Model type	Model name	15	18	20	22	25	35	42	50	60	71
Wall mounted	MSZ-LN**VG	●									
	MSZ-LN**VG2	●									*
	MSZ-EF**VE3	●									
	MSZ-AP**VG	●									
1way cassette	MLZ-KP**VF										
4way cassette	SLZ-M**FA										
Ceiling concealed	PEAD-M**JA(L)										
Ceiling suspended	SEZ-M**DA(L)										
Ceiling suspended	PCA-M**KA										

*1: Models with service sub number -E2/ET2 are connectable.

<MXZ-3F68VF2 / MXZ-4F72VF2 / MXZ-4F80VF2>

Connectable indoor unit lineups(Heat pump inverter type)		Capacity class [kW/h]									
Model type	Model name	15	18	20	22	25	35	42	50	60	71
Wall mounted	MSZ-LN**VG	●									
	MSZ-LN**VG2	●									

<MXZ-4F83VF / MXZ-5F102VF /
MXZ-6F122VF / MXZ-4F83VFHZ>

Connectable indoor unit lineups(Heat pump inverter type)		Capacity class [kW/h]									
Model type	Model name	15	18	20	22	25	35	42	50	60	71
Wall mounted	MSZ-LN**VG2			●			●	●		●	
	MSZ-BT**VG				●		●	●			
	MSZ-EF**VG			●	●		●	●	●	●	
	MSZ-AP**VG	●		●			●	●	●	●	●
1way cassette	MLZ-KP**VF						●	●		●	
Floor standing	MFZ-KT**VG						●	●		●	
4way cassette	SLZ-M**FA	●					●	●		●	
Floor standing	SFZ-M**VA						●	●		●	●
Ceiling concealed	SEZ-M**DA(L)						●	●		●	●

<MXZ-2F53VFHZ>

Connectable indoor unit lineups(Heat pump inverter type)		Capacity class [kW/h]									
Model type	Model name	15	18	20	22	25	35	42	50	60	71
Wall mounted	MSZ-LN**VG2			●			●	●			
	MSZ-BT**VG				●		●	●			
	MSZ-EF**VG			●	●		●	●	●	●	
	MSZ-AP**VG	●		●			●	●	●	●	
1way cassette	MLZ-KP**VF						●	●		●	
Floor standing	MFZ-KT**VG						●	●		●	
4way cassette	SLZ-M**FA	●					●	●		●	
Floor standing	SFZ-M**VA						●	●		●	
Ceiling concealed	SEZ-M**DA(L)						●	●		●	

MXZ-2F33VF -^[E1], ^[ET1]

MXZ-2F42VF -^[E1], ^[ET1]

MXZ-2F53VF -^[E1], ^[ET1]

MXZ-2F53VFH -^[E1]

MXZ-3F54VF -^[E1], ^[ET1]

MXZ-3F68VF -^[E1], ^[ET1]

MXZ-4F72VF -^[E1], ^[ET1]

MXZ-4F83VF -^[E1], ^[ET1]

MXZ-5F102VF -^[E1], ^[ET1]

MXZ-6F122VF -^[E1], ^[ET1]

MXZ-2F53VFHZ -^[E1]

MXZ-4F83VFHZ -^[E1]

1. New model

MXZ-3F54VF -^[E1], ^[ET1] → **MXZ-3F54VF** -^[E2], ^[ET2]

MXZ-3F68VF -^[E1], ^[ET1] → **MXZ-3F68VF** -^[E2], ^[ET2]

MXZ-4F72VF -^[E1], ^[ET1] → **MXZ-4F72VF** -^[E2], ^[ET2]

1. LEV-R has been changed.

2. Outdoor control P. C. board has been changed.

MXZ-3F54VF -^[E2], ^[ET2] → **MXZ-3F54VF2** -^[E1], ^[ET1]

MXZ-3F68VF -^[E2], ^[ET2] → **MXZ-3F68VF2** -^[E1], ^[ET1]

MXZ-4F72VF -^[E2], ^[ET2] → **MXZ-4F72VF2** -^[E1], ^[ET1]

1. Pre charged refrigerant amount and additional refrigerant amount have been changed.

2. Outdoor control P.C. board has been changed.

3. Power board has been changed.

4. LEV R has been changed.

MXZ-4F80VF2 -^[E1], ^[ET1]

1. New model

MXZ-2F33VF -^[E1], ^[ET1] → **MXZ-2F33VF2** -^[E1], ^[ET1]

MXZ-2F42VF -^[E1], ^[ET1] → **MXZ-2F42VF2** -^[E1], ^[ET1]

MXZ-2F53VF -^[E1], ^[ET1] → **MXZ-2F53VF2** -^[E1], ^[ET1]

MXZ-2F53VFH -^[E1] → **MXZ-2F53VFH2** -^[E1], ^[ET1]

1. Outdoor control P.C. board has been changed.

2. Outdoor fan motor has been changed.

MXZ-2F33VF2 -^[E1], ^[ET1] → **MXZ-2F33VF3** -^[E1], ^[ET1]

MXZ-2F42VF2 -^[E1], ^[ET1] → **MXZ-2F42VF3** -^[E1], ^[ET1]

MXZ-2F53VF2 -^[E1], ^[ET1] → **MXZ-2F53VF3** -^[E1], ^[ET1]

MXZ-2F53VFH2 -^[E1] → **MXZ-2F53VFH3** -^[E1]

MXZ-3F54VF2 -^[E1], ^[ET1] → **MXZ-3F54VF3** -^[E1], ^[ET1]

MXZ-3F68VF2 -^[E1], ^[ET1] → **MXZ-3F68VF3** -^[E1], ^[ET1]

MXZ-4F72VF2 -^[E1], ^[ET1] → **MXZ-4F72VF3** -^[E1], ^[ET1]

MXZ-4F80VF2 -^[E1], ^[ET1] → **MXZ-4F80VF3** -^[E1], ^[ET1]

MXZ-2F33VF3 -^[E1] → **MXZ-2F33VF3** -^[E2]





MXZ-2F42VF3 -^[E1] → **MXZ-2F42VF3** -^[E2]

MXZ-2F53VF3 -^[E1] → **MXZ-2F53VF3** -^[E2]

MXZ-2F53VFH3 -^[E1] → **MXZ-2F53VFH3** -^[E2]

1. Model name has been changed.

MEANINGS OF SYMBOLS DISPLAYED ON THE UNIT

	WARNING (Risk of fire)	This mark is for R32 refrigerant only. Refrigerant type is written on nameplate of outdoor unit. In case that refrigerant type is R32, this unit uses a flammable refrigerant. If refrigerant leaks and comes in contact with fire or heating part, it will create harmful gas and there is risk of fire.
	Read the OPERATION MANUAL carefully before operation.	
	Service personnel are required to carefully read the OPERATION MANUAL and INSTALLATION MANUAL before operation.	
	Further information is available in the OPERATION MANUAL, INSTALLATION MANUAL, and the like.	

2-1. ALWAYS OBSERVE FOR SAFETY

Before obtaining access to terminal, all supply circuits must be disconnected.

2-2. CAUTIONS RELATED TO NEW REFRIGERANT

Cautions for units utilizing refrigerant R32

Preparation before the repair service.

- Prepare the proper tools.
- Prepare the proper protectors.
- Provide adequate ventilation.
- After stopping the operation of the air conditioner, turn off the power-supply breaker.
- Discharge the condenser before the work involving the electric parts.

Use new refrigerant pipes.

- In case of using the existing pipes for R22, be careful with the following.
- Be sure to clean the pipes and make sure that the insides of the pipes are clean.
 - Change flare nut to the one provided with this product. Use a newly flared pipe.
 - Avoid using thin pipes.

Make sure that the inside and outside of refrigerant piping is clean and it has no contaminants such as sulfur, oxides, dirt, shaving particles, etc, which are hazard to refrigerant cycle. In addition, use pipes with specified thickness.

Contamination inside refrigerant piping can cause deterioration of refrigerant oil, etc.

Store the piping indoors, and both ends of the piping sealed until just before brazing. (Leave elbow joints, etc. in their packaging.)

If dirt, dust or moisture enters into refrigerant cycle, that can cause deterioration of refrigerant oil or malfunction of compressor.

Precautions during the repair service.

- Do not perform the work involving the electric parts with wet hands.
- Do not pour water into the electric parts.
- Do not touch the refrigerant.
- Do not touch the hot or cold areas in the refrigerating cycle.
- When the repair or the inspection of the circuit needs to be done without turning off the power, exercise great caution not to touch the live parts.
- When opening or closing the valve below freezing temperatures, refrigerant may spurt out from the valve gap, resulting in injuries.

Use a vacuum pump with a reverse flow check valve.

Vacuum pump oil may flow back into refrigerant cycle and that can cause deterioration of refrigerant oil, etc.

Use the following tools specifically designed for use with R32 refrigerant.

The following tools are necessary to use R32 refrigerant.

Tools for R32	
Gauge manifold	Flare tool
Charge hose	Size adjustment gauge
Gas leak detector	Vacuum pump adaptor
Torque wrench	Electronic refrigerant charging scale

Handle tools with care.

If dirt, dust or moisture enters into refrigerant cycle, that can cause deterioration of refrigerant oil or malfunction of compressor.

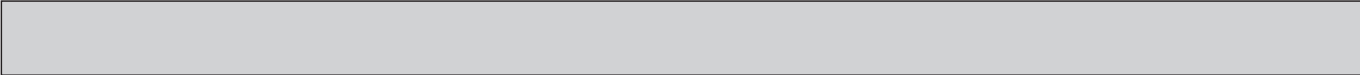

The refrigerant oil applied to flare and flange connections must be ester oil, ether oil or alkylbenzene oil in a small amount.

If large amount of mineral oil enters, that can cause deterioration of refrigerant oil, etc.

Do not use refrigerant other than R32.

If other refrigerant (R22, etc.) is used, chlorine in refrigerant can cause deterioration of refrigerant oil, etc.

Use the specified refrigerant only.

Never use any refrigerant other than that specified.
Doing so may cause a burst, an explosion, or fire when the unit is being used, serviced, or disposed of.
Correct refrigerant is specified in the manuals and on the spec labels provided with our products.
We will not be held responsible for mechanical failure, system malfunction, unit breakdown or accidents caused by failure to follow the instructions.

Ventilate the room if refrigerant leaks during operation. If refrigerant comes into contact with a flame, poisonous gases will be released.

[1] Warning for service

- (1) Do not alter the unit.
- (2) For installation and relocation work, follow the instructions in the Installation Manual and use tools and pipe components specifically made for use with refrigerant specified in the outdoor unit installation manual.
- (3) Ask a dealer or an authorized technician to install, relocate and repair the unit.
For appliances not accessible to the general public.
- (4) Refrigerant pipes connection shall be accessible for maintenance purposes.
- (5) If the air conditioner is installed in a small room or closed room, measures must be taken to prevent the refrigerant concentration in the room from exceeding the safety limit in the event of refrigerant leakage. Should the refrigerant leak and cause the concentration limit to be exceeded, hazards due to lack of oxygen in the room may result.
- (6) Keep gas-burning appliances, electric heaters, and other fire sources (ignition sources) away from the location where installation, repair, and other air conditioner work will be performed.
If refrigerant comes into contact with a flame, poisonous gases will be released.
- (7) When installing or relocating, or servicing the air conditioner, use only the specified refrigerant (R32) to charge the refrigerant lines.
Do not mix it with any other refrigerant and do not allow air to remain in the lines.
If air is mixed with the refrigerant, then it can be the cause of abnormal high pressure in the refrigerant line, and may result in an explosion and other hazards.
- (8) After installation has been completed, check for refrigerant leaks. If refrigerant leaks into the room and comes into contact with the flame of a heater or portable cooking range, poisonous gases will be released.
- (9) Do not use low temperature solder alloy in case of brazing the refrigerant pipes.
- (10) When performing brazing work, be sure to ventilate the room sufficiently. Make sure that there are no hazardous or flammable materials nearby.
When performing the work in a closed room, small room, or similar location, make sure that there are no refrigerant leaks before performing the work.
If refrigerant leaks and accumulates, it may ignite or poisonous gases may be released.
- (11) Do not install the unit in places where refrigerant may build-up or places with poor ventilation such as a semi-basement or a sunken place in outdoor: Refrigerant is heavier than air, and inclined to fall away from the leak source.
- (12) Do not use means to accelerate the defrosting process or to clean, other than those recommended by the manufacturer.
- (13) The appliance shall be stored in a room without continuously operating ignition sources (for example: open flames, an operating gas appliance or an operating electric heater).
- (14) Do not pierce or burn.
- (15) Be aware that refrigerants may not contain an odour.
- (16) Pipe-work shall be protected from physical damage.
- (17) The installation of pipe-work shall be kept to a minimum.
- (18) Compliance with national gas regulations shall be observed.
- (19) Keep any required ventilation openings clear of obstruction.
- (20) Servicing shall be performed only as recommended by the manufacturer.
- (21) The appliance shall be stored in a well-ventilated area where the room size corresponds to the room area as specified for operation.
- (22) Maintenance, service and repair operations shall be performed by authorized technician with required qualification.
- (23) Be sure to have appropriate ventilation in order to prevent ignition. Furthermore, be sure to carry out fire prevention measures that there are no dangerous or flammable objects in the surrounding area.

[2] Cautions for service

- (1) Perform service after recovering the refrigerant left in unit completely.
- (2) Do not release refrigerant in the air.
- (3) After completing service, charge the cycle with specified amount of refrigerant.
- (4) When performing service, install a filter drier simultaneously.
Be sure to use a filter drier for new refrigerant.

[3] Additional refrigerant charge

When charging directly from cylinder

R32 is a single refrigerant and its composition does not change. Therefore, both liquid charging and gas charging are possible. Liquid charging of refrigerant all at once from the low-pressure side may cause the compressor malfunction. Accordingly, make sure that charging is gradual.

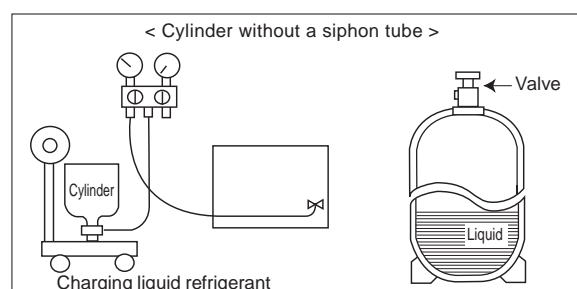
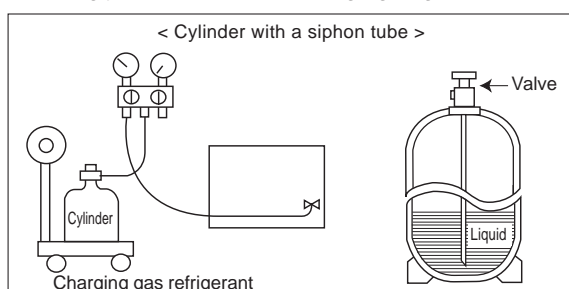

[4] Cautions for unit using R32 refrigerant

Basic work procedures are the same as those for conventional units using refrigerant R410A. However, pay careful attention to the following points.

(1) Information on servicing

(1-1) Checks on the Area

Prior to beginning work on systems containing flammable refrigerants, safety checks are necessary to ensure that the risk of ignition is minimized.

For repair to the refrigerating systems, (1-3) to (1-7) shall be completed prior to conducting work on the systems.

(1-2) Work Procedure

Work shall be undertaken under a controlled procedure so as to minimize the risk of a flammable gas or vapor being present while the work is being performed.

(1-3) General Work Area

All maintenance staff and others working in the local area shall be instructed on the nature of work being carried out.

Work in confined spaces shall be avoided. The area around the workspace shall be sectioned off. Ensure that the conditions within the area have been made safe by control of flammable material.

(1-4) Checking for Presence of Refrigerant

The area shall be checked with an appropriate refrigerant detector prior to and during work, to ensure the technician is aware of potentially toxic or flammable atmospheres. Ensure that the leak detection equipment being used is suitable for use with all applicable refrigerants, i.e. non-sparking, adequately sealed or intrinsically safe.

(1-5) Presence of Fire Extinguisher

If any hot work is to be conducted on the refrigeration equipment or any associated parts, appropriate fire extinguishing equipment shall be available to hand.

Have a dry powder or CO2 fire extinguisher adjacent to the charging area.

(1-6) No Ignition Sources

No person carrying out work in relation to a refrigeration system which involves exposing any pipe work shall use any sources of ignition in such a manner that it may lead to the risk of fire or explosion. All possible ignition sources, including cigarette smoking, should be kept sufficiently far away from the site of installation, repairing, removing and disposal, during which refrigerant can possibly be released to the surrounding space. Prior to work taking place, the area around the equipment is to be surveyed to make sure that there are no flammable hazards or ignition risks. "No Smoking" signs shall be displayed.

(1-7) Ventilated Area

Ensure that the area is in the open or that it is adequately ventilated before breaking into the system or conducting any hot work. A degree of ventilation shall continue during the period that the work is carried out. The ventilation should safely disperse any released refrigerant and preferably expel it externally into the atmosphere.

(1-8) Checks on the Refrigeration Equipment

Where electrical components are being changed, they shall be fit for the purpose and to the correct specification. At all times the manufacturer's maintenance and service guidelines shall be followed. If in doubt, consult the manufacturer's technical department for assistance.

The following checks shall be applied to installations using flammable refrigerants:

- The charge size is in accordance with the room size within which the refrigerant containing parts are installed.
- The ventilation machinery and outlets are operating adequately and are not obstructed.
- Marking to the equipment continues to be visible and legible. Markings and signs that are illegible shall be corrected.
- Refrigeration pipe or components are installed in a position where they are unlikely to be exposed to any substance which may corrode refrigerant containing components, unless the components are constructed of materials which are inherently resistant to being corroded or are suitably protected against being corroded.

(1-9) Checks on Electrical Devices

Repair and maintenance to electrical components shall include initial safety checks and component inspection procedures. If a fault exists that could compromise safety, then no electrical supply shall be connected to the circuit until it is satisfactorily dealt with. If the fault cannot be corrected immediately but it is necessary to continue operation, an adequate temporary solution shall be used. This shall be reported to the owner of the equipment so all parties are advised. Initial safety checks shall include that:

- capacitors are discharged: this shall be done in a safe manner to avoid possibility of sparking;
- no live electrical components and wiring are exposed while charging, recovering or purging the system;
- there is continuity of earth bonding

(2) Repairs to Sealed Components

(2-1) During repairs to sealed components, all electrical supplies shall be disconnected from the equipment being worked upon prior to any removal of sealed covers, etc. If it is absolutely necessary to have an electrical supply to equipment during servicing, then a permanently operating form of leak detection shall be located at the most critical point to warn of a potentially hazardous situation.

(2-2) Particular attention shall be paid to the following to ensure that by working on electrical components, the casing is not altered in such a way that the level of protection is affected. This shall include damage to cables, excessive number of connections, terminals not made to original specification, damage to seals, incorrect fitting of glands, etc.

Ensure that the apparatus is mounted securely.

Ensure that seals or sealing materials have not degraded to the point that they no longer serve the purpose of preventing the ingress of flammable atmospheres.

Replacement parts shall be in accordance with the manufacturer's specifications.

(3) Repair to intrinsically Safe Components

Do not apply any permanent inductive or capacitance loads to the circuit without ensuring that this will not exceed the permissible voltage and current permitted for the equipment in use.

Intrinsically safe components are the only types that can be worked on while live in the presence of a flammable atmosphere. The test apparatus shall be at the correct rating.

Replace components only with parts specified by the manufacturer. Other parts may result in the ignition of refrigerant in the atmosphere from a leak.

(4) Cabling

Check that cabling will not be subject to wear, corrosion, excessive pressure, vibration, sharp edges or any other adverse environmental effects. The check shall also take into account the effects of aging or continual vibration from sources such as compressors or fans.

(5) Detection of Flammable Refrigerants

Under no circumstances shall potential sources of ignition be used in the searching for or detection of refrigerant leaks.

A halide torch (or any other detector using a naked flame) shall not be used.

(6) Leak Detection Methods

Electronic leak detectors may be used to detect refrigerant leaks but, in the case of flammable refrigerants, the sensitivity may not be adequate, or may need re-calibration. (Detection equipment shall be calibrated in a refrigerant-free area.)

Ensure that the detector is not a potential source of ignition and is suitable for the refrigerant used. Leak detection equipment shall be set at a percentage of the LFL of the refrigerant and shall be calibrated to the refrigerant employed, and the appropriate percentage of gas (25% maximum) is confirmed.

Leak detection fluids are suitable for use with most refrigerants but the use of detergents containing chlorine shall be avoided as the chlorine may react with the refrigerant and corrode the copper pipe-work.

If a leak is suspected, all naked flames shall be removed/extinguished.

If a leakage of refrigerant is found which requires brazing, all of the refrigerant shall be recovered from the system, or isolated (by means of shut off valves) in a part of the system remote from the leak. For appliances containing flammable refrigerants, oxygen free nitrogen (OFN) shall then be purged through the system both before and during the brazing process.

(7) Removal and Evacuation

When breaking into the refrigerant circuit to make repairs – or for any other purpose conventional procedures shall be used. However, for flammable refrigerants it is important that best practice is followed since flammability is a consideration. The following procedure shall be adhered to:

- remove refrigerant
- purge the circuit with inert gas
- evacuate
- purge again with inert gas
- open the circuit by cutting or brazing.

The refrigerant charge shall be recovered into the correct recovery cylinders. For appliances containing flammable refrigerants, the system shall be “flushed” with OFN to render the unit safe. This process may need to be repeated several times.

Compressed air or oxygen shall not be used for purging refrigerant systems.

For appliances containing flammable refrigerants, flushing shall be achieved by breaking the vacuum in the system with OFN and continuing to fill until the working pressure is achieved, then venting to atmosphere, and finally pulling down to a vacuum. This process shall be repeated until no refrigerant is within the system. When the final OFN charge is used, the system shall be vented down to atmospheric pressure to enable work to take place. This operation is absolutely vital if brazing operations on the pipe-work are to take place.

Ensure that the outlet for the vacuum pump is not close to any ignition sources and that ventilation is available.

(8) Charging Procedures

In addition to conventional charging procedures, the following requirements shall be followed:

- Ensure that contamination of different refrigerants does not occur when using charging equipment. Hoses or lines shall be as short as possible to minimize the amount of refrigerant contained in them.
- Cylinders shall be kept upright.
- Ensure that the refrigeration system is earthed prior to charging the system with refrigerant.
- Label the system when charging is complete (if not already).
- Extreme care shall be taken not to overfill the refrigeration system.

Prior to recharging the system, it shall be pressure-tested with the appropriate purging gas. The system shall be leak-tested on completion of charging but prior to commissioning. A follow up leak test shall be carried out prior to leaving the site.

(9) Decommissioning

Before carrying out this procedure, it is essential that the technician is completely familiar with the equipment and all its detail. It is recommended good practice that all refrigerants are recovered safely. Prior to the task being carried out, an oil and refrigerant sample shall be taken in case analysis is required prior to re-use of reclaimed refrigerant. It is essential that electrical power is available before the task is commenced.

- a) Become familiar with the equipment and its operation.

- b) Isolate system electrically.
- c) Before attempting the procedure, ensure that:
 - mechanical handling equipment is available, if required, for handling refrigerant cylinders;
 - all personal protective equipment is available and being used correctly;
 - the recovery process is supervised at all times by a competent person;
 - recovery equipment and cylinders conform to the appropriate standards.
- d) Pump down refrigerant system, if possible.
- e) If a vacuum is not possible, make a manifold so that refrigerant can be removed from various parts of the system.
- f) Make sure that cylinder is situated on the scales before recovery takes place.
- g) Start the recovery machine and operate in accordance with manufacturer's instructions.
- h) Do not overfill cylinders. (No more than 80 % volume liquid charge).
- i) Do not exceed the maximum working pressure of the cylinder, even temporarily.
- j) When the cylinders have been filled correctly and the process completed, make sure that the cylinders and the equipment are removed from site promptly and all isolation valves on the equipment are closed off.
- k) Recovered refrigerant shall not be charged into another refrigeration system unless it has been cleaned and checked.

(10) Labelling

Equipment shall be labelled stating that it has been de-commissioned and emptied of refrigerant. The label shall be dated and signed. For appliances containing flammable refrigerants, ensure that there are labels on the equipment stating the equipment contains flammable refrigerant.

(11) Recovery

When removing refrigerant from a system, either for servicing or decommissioning, it is recommended good practice that all refrigerants are removed safely. When transferring refrigerant into cylinders, ensure that only appropriate refrigerant recovery cylinders are employed. Ensure that the correct number of cylinders for holding the total system charge are available. All cylinders to be used are designated for the recovered refrigerant and labelled for that refrigerant (i.e. special cylinders for the recovery of refrigerant). Cylinders shall be complete with pressure-relief valve and associated shut-off valves in good working order. Empty recovery cylinders are evacuated and, if possible, cooled before recovery occurs.

The recovery equipment shall be in good working order with a set of instructions concerning the equipment that is at hand and shall be suitable for the recovery of all appropriate refrigerants including, when applicable, flammable refrigerants. In addition, a set of calibrated weighing scales shall be available and in good working order. Hoses shall be complete with leak-free disconnect couplings and in good condition. Before using the recovery machine, check that it is in satisfactory working order, has been properly maintained and that any associated electrical components are sealed to prevent ignition in the event of a refrigerant release. Consult manufacturer if in doubt.

The recovered refrigerant shall be returned to the refrigerant supplier in the correct recovery cylinder, and the relevant waste transfer note arranged. Do not mix refrigerants in recovery units and especially not in cylinders. If compressors or compressor oils are to be removed, ensure that they have been evacuated to an acceptable level to make certain that flammable refrigerant does not remain within the lubricant. The evacuation process shall be carried out prior to returning the compressor to the suppliers. Only electric heating to the compressor body shall be employed to accelerate this process. When oil is drained from a system, it shall be carried out safely.

[5] Service tools

Use the below service tools as exclusive tools for R32 refrigerant.

No.	Tool name	Specifications
①	Gauge manifold	<ul style="list-style-type: none"> · Only for R32 · Use the existing fitting specifications. (UNF1/2) · Use high-tension side pressure of 5.3MPa·G or over.
②	Charge hose	<ul style="list-style-type: none"> · Only for R32 · Use pressure performance of 5.09MPa·G or over.
③	Electronic scale	—
④	Gas leak detector	· Use the detector for R134a, R407C, R410a or R32.
⑤	Adaptor for reverse flow check	· Attach on vacuum pump.
⑥	Refrigerant charge base	—
⑦	Refrigerant cylinder	<ul style="list-style-type: none"> · Only for R32 · Cylinder with syphon
⑧	Refrigerant recovery equipment	—

2-3. PRECAUTIONS WHEN REUSING EXISTING R22/R410a REFRIGERANT PIPES

(1) Flowchart

- Refer to the flowchart below to determine if the existing pipes can be used and if it is necessary to use a filter dryer.
- If the diameter of the existing pipes is different from the specified diameter, refer to technological data materials to confirm if the pipes can be used.

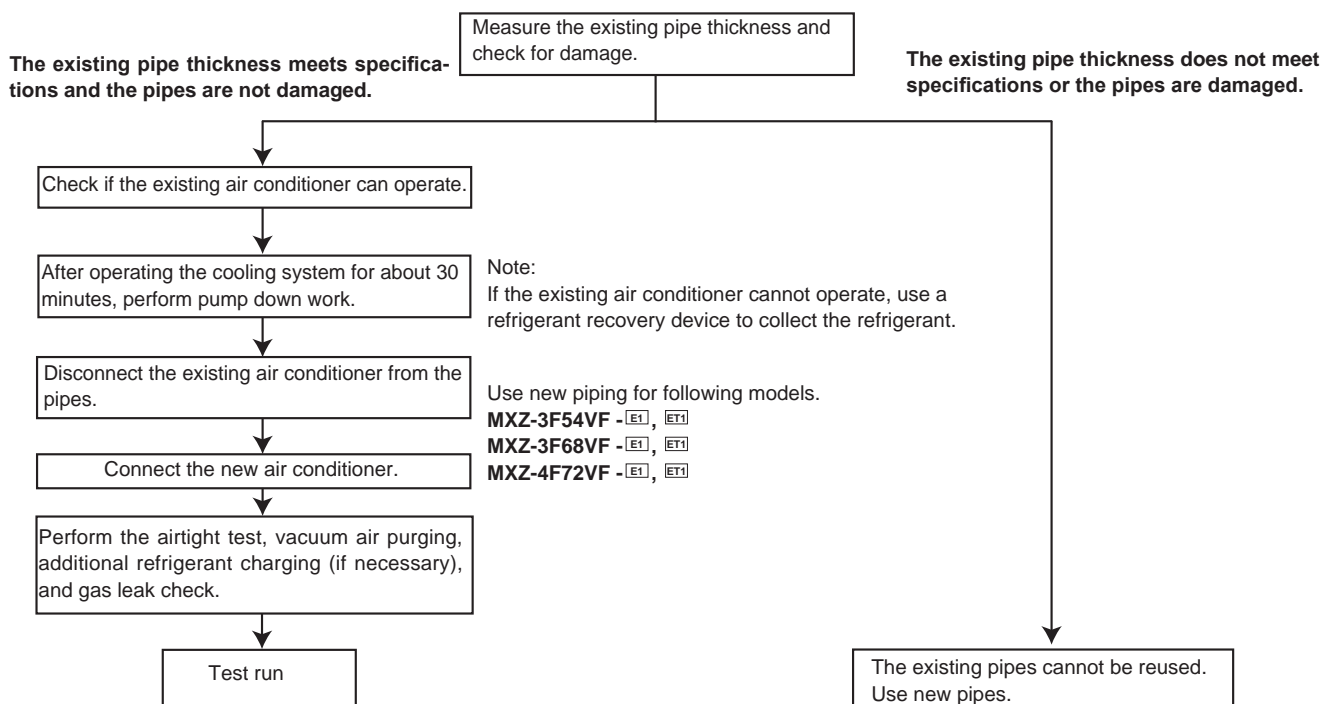

(2) Cautions for refrigerant piping work

New refrigerant R32 is adopted for replacement inverter series. Although the refrigerant piping work for R32 is same as for R22, exclusive tools are necessary so as not to mix with different kind of refrigerant. Furthermore as the working pressure of R32 is 1.6 times higher than that of R22, their sizes of flared sections and flare nuts are different.

① Thickness of pipes

Because the working pressure of R32 is higher compared to R22, be sure to use refrigerant piping with thickness shown below. (Never use pipes of 0.7 mm or below.)

Diagram below: Piping diameter and thickness

Nominal dimensions(inch)	Outside diameter (mm)	Thickness (mm)	
		R32/R410a	R22
1/4	6.35	0.8	0.8
3/8	9.52	0.8	0.8
1/2	12.70	0.8	0.8
5/8	15.88	1.0	1.0
3/4	19.05	—	1.0

② Dimensions of flare cutting and flare nut

The component molecules in HFC refrigerant are smaller compared to conventional refrigerants. In addition to that, R32 is a refrigerant, which has higher risk of leakage because its working pressure is higher than that of other refrigerants. Therefore, to enhance airtightness and strength, flare cutting dimension of copper pipe for R32 has been specified separately from the dimensions for other refrigerants as shown below. The dimension B of flare nut for R32 also has partly been changed to increase strength as shown below. Set copper pipe correctly referring to copper pipe flaring dimensions for R32 below. For 1/2 and 5/8 inch pipes, the dimension B changes. Use torque wrench corresponding to each dimension.

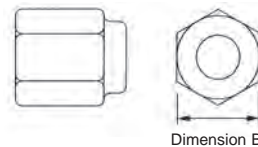
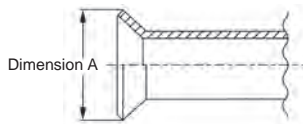

Flare cutting dimensions

Nominal dimensions(inch)	Outside diameter(mm)	Dimension A (+0.4 / -0.4) (mm)	
		R32/R410a	R22
1/4	6.35	9.1	9.0
3/8	9.52	13.2	13.0
1/2	12.70	16.6	16.2
5/8	15.88	19.7	19.4
3/4	19.05	—	23.3

Flare nut dimensions

Nominal dimensions(inch)	Outside diameter(mm)	Dimension B (mm)	
		R32/R410a	R22
1/4	6.35	17.0	17.0
3/8	9.52	22.0	22.0
1/2	12.70	26.0	24.0
5/8	15.88	29.0 *	27.0
3/4	19.05	—	36.0

* 36.0mm for indoor unit of RP100, 125 and 140

③ Tools for R32 (The following table shows whether conventional tools can be used or not.)

Tools and materials	Use	R32 tools	Can R22 tools be used?	Can R407C tools be used?	Can R410a tools be used?
Gauge manifold	Air purge, refrigerant charge and operation check	Tool exclusive for R32	×	×	○
Charge hose	Gas leak check	Tool exclusive for R32	×	×	○
Gas leak detector	Refrigerant recovery	Tool for HFC refrigerant	×	○	○
Refrigerant recovery equipment	Refrigerant charge	Tool exclusive for R32	×	×	○
Refrigerant cylinder	Prevent compressor malfunction when charging refrigerant by spraying liquid refrigerant	Tool exclusive for R32	×	×	×
Safety charger	Prevent gas from blowing out when detaching charge hose	Tool exclusive for R32	×	×	○
Charge valve	Vacuum drying and air purge	Tools for other refrigerants can be used if equipped with adapter for reverse flow check	△(Usable if equipped with adapter for reverse flow)	△(Usable if equipped with adapter for reverse flow)	△(Usable if equipped with adapter for reverse flow)
Vacuum pump	Flaring work of piping	Tools for other refrigerants can be used by adjusting flaring dimension	△(Usable by adjusting flaring dimension)	△(Usable by adjusting flaring dimension)	△(Usable by adjusting flaring dimension)
Flare tool	Bend the pipes	Tools for other refrigerants can be used	○	○	○
Bender	Cut the pipes	Tools for other refrigerants can be used	○	○	○
Pipe cutter	Weld the pipes	Tools for other refrigerants can be used	○	○	○
Welder and nitrogen gas cylinder	Refrigerant charge	Tools for other refrigerants can be used	○	○	○
Refrigerant charging scale	Check the degree of vacuum. (Vacuum valve prevents back flow of oil and refrigerant to thermistor vacuum gauge)	Tools for other refrigerants can be used	○	○	○
Vacuum gauge or thermistor vacuum gauge and vacuum valve	Refrigerant charge	Tool exclusive for R32	×	—	×
Charging cylinder					

× : Prepare a new tool. (Use the new tool as the tool exclusive for R32.)

△ : Tools for other refrigerants can be used under certain conditions.

○ : Tools for other refrigerants can be used.

2-4. CHOOSING THE OUTDOOR UNIT INSTALLATION LOCATION

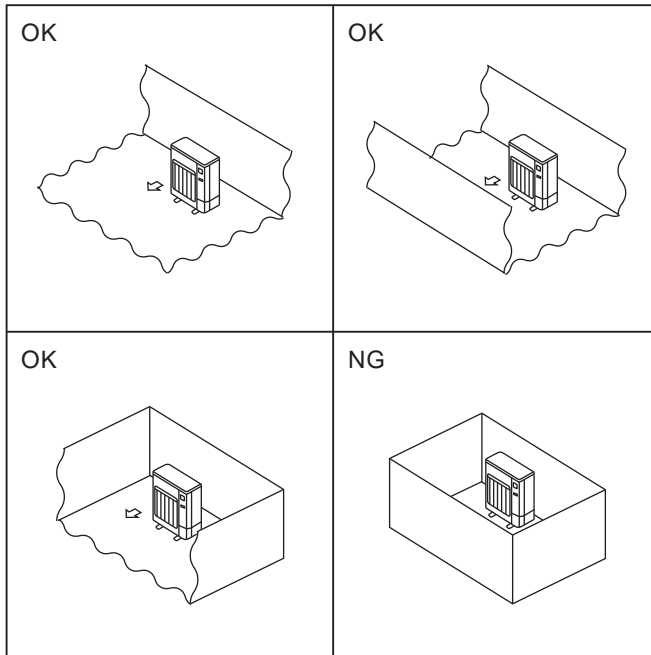

R32 is heavier than air—as well as other refrigerants—so tends to accumulate at the base (in the vicinity of the floor). If R32 accumulates around base, it may reach a flammable concentration in case room is small. To avoid ignition, maintaining a safe work environment is required by ensuring appropriate ventilation. If a refrigerant leak is confirmed in a room or an area where there is insufficient ventilation, refrain from using of flames until the work environment can be improved by ensuring appropriate ventilation.

Install outdoor unit in a place where at least one of the four sides is open, and in a sufficiently large space without depressions.

2-5. MINIMUM INSTALLATION AREA

If you unavoidably install a unit in a space where all four sides are blocked or there are depressions, confirm that one of these situations (A, B or C) is satisfied.

Note: These countermeasures are for keeping safety not for specification guarantee.

A) Secure sufficient installation space (minimum installation area A_{min}).

Install in a space with an installation area of A_{min} or more, corresponding to refrigerant quantity M (factory-charged refrigerant + locally added refrigerant).

M [kg]	A_{min} [m ²]
1.0	12
1.5	17
2.0	23
2.5	28
3.0	34
3.5	39
4.0	45
4.5	50
5.0	56
5.5	62
6.0	67
6.5	73
7.0	78
7.5	84

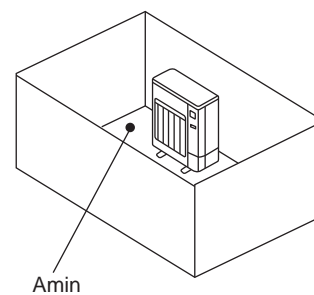

B) Install in a space with a depression height of 0.125 [m] or less.

Height from the bottom of
0.125 [m] or less

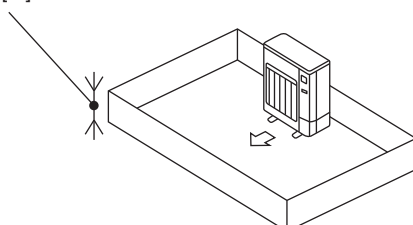

Height from the bottom of
0.125 [m] or less

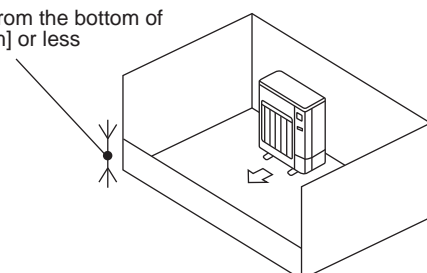

C) Create an appropriate ventilation open area.

Make sure that the width of the open area is 0.9 [m] or more and the height of the open area is 0.15 [m] or more. However, the height from the bottom of the installation space to the bottom edge of the open area should be 0.125 [m] or less. Open area should be 75% or more opening.

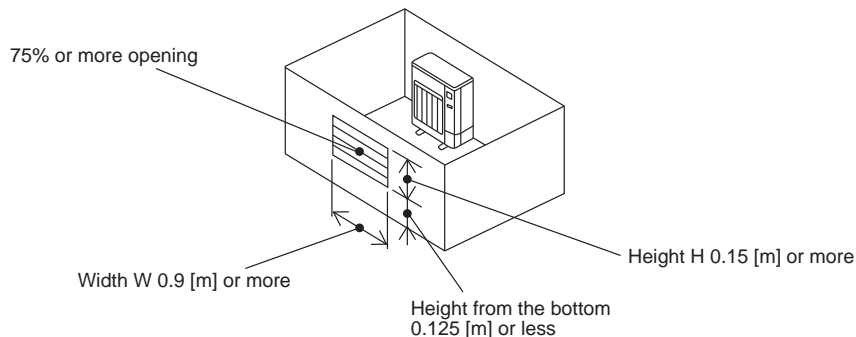

■ Indoor units

Install in a room with a floor area of A min or more, corresponding to refrigerant quantity M (factory-charged refrigerant + locally added refrigerant).

* For the factory-charged refrigerant amount, refer to the spec nameplate or installation manual.

For the amount to be added locally, refer to the installation manual.

Install the indoor unit so that the height from the floor to the bottom of the indoor unit is h0;

for wall mounted: 1.8 m or more;

for ceiling suspended, cassette and ceiling concealed: 2.2 m or more.

When installing floor standing, refer to indoor unit Installation manual.

There are restrictions in installation height for each model, so read the installation manual for the particular unit.

Case 1: for wall mounted, ceiling suspended, cassette and concealed

M [kg]	Amin [m ²]
1.0	3
1.5	4.5
2.0	6
2.5	7.5
3.0	9
3.5	12
4.0	15.5
4.5	20
5.0	24
5.5	29
6.0	35
6.5	41
7.0	47
7.5	54

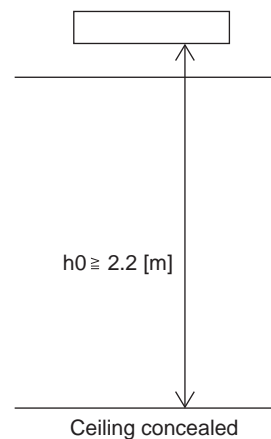
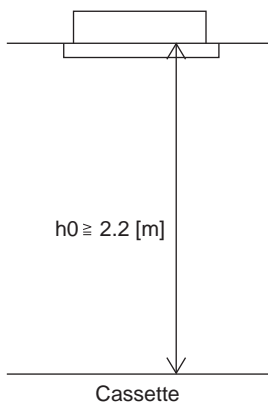
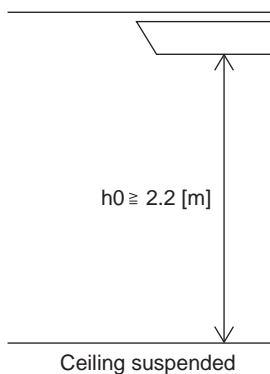
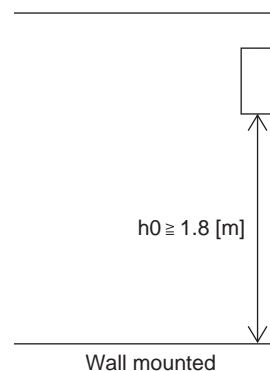

3

PART NAMES AND FUNCTIONS

MXZ-2F33VF MXZ-2F33VF2 MXZ-2F33VF3
 MXZ-2F42VF MXZ-2F42VF2 MXZ-2F42VF3
 MXZ-2F53VF MXZ-2F53VF2 MXZ-2F53VF3
 MXZ-2F53VFH MXZ-2F53VFH2 MXZ-2F53VFH3

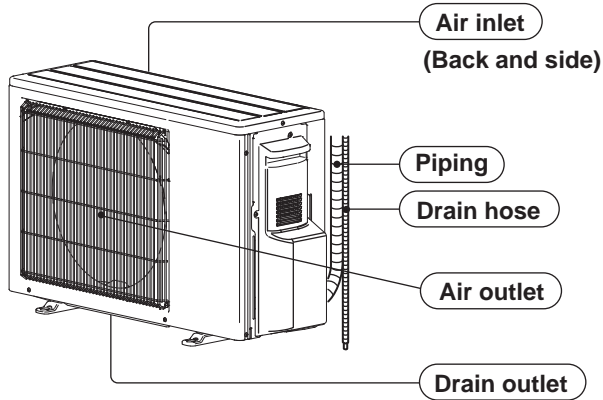

MXZ-3F54VF MXZ-3F54VF2 MXZ-3F54VF3
 MXZ-3F68VF MXZ-3F68VF2 MXZ-3F68VF3
 MXZ-4F72VF MXZ-4F72VF2 MXZ-4F72VF3
 MXZ-4F80VF2 MXZ-4F80VF3

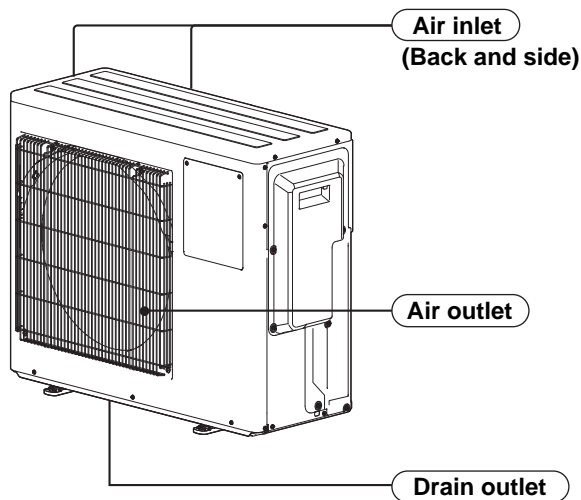

ACCESSORIES

Model	MXZ-2F33VF	MXZ-2F33VF2	MXZ-2F33VF3	MXZ-3F54VF	MXZ-3F54VF2	MXZ-3F54VF3
		MXZ-2F42VF	MXZ-2F42VF2	MXZ-2F42VF3	MXZ-3F68VF	MXZ-3F68VF2
	MXZ-2F53VF	MXZ-2F53VF2	MXZ-2F53VF3	MXZ-4F72VF	MXZ-4F72VF2	MXZ-4F72VF3
					MXZ-4F80VF2	MXZ-4F80VF3
① Drain socket		1			1	
② Drain cap		-			2	

MXZ-4F83VF
 MXZ-5F102VF
 MXZ-2F53VFHZ

MXZ-4F83VFHZ
 MXZ-6F122VF

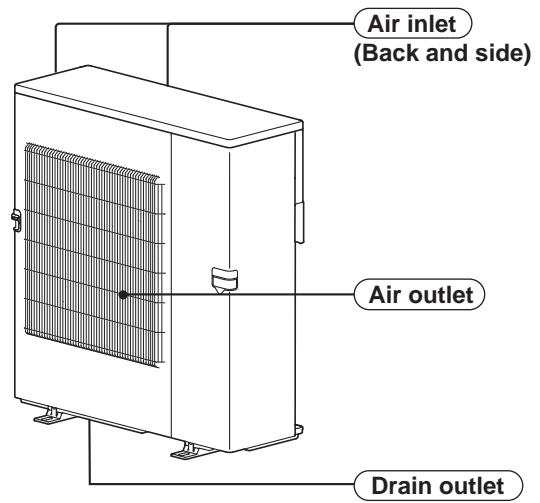
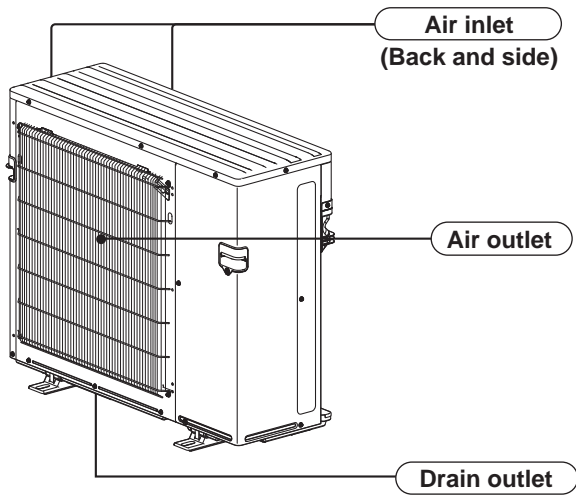

ACCESSORIES

Model	MXZ-4F83VF	MXZ-5F102VF	MXZ-6F122VF
① Drain socket		1	
② Drain cap		5	

4

SPECIFICATION

Outdoor model		MXZ-2F33VF		
Outdoor unit power supply		Single phase 220 - 230 - 240 V, 50 Hz		
System	Indoor units number	2		
	Piping total length	m	Max. 20	
	Connecting pipe length	m	Max. 15	
	Height difference (Indoor ~ Outdoor)	m	Refer to 8 REFRIGERANT SYSTEM DIAGRAM.	
	Height difference (Indoor ~ Indoor)	m	Refer to 8 REFRIGERANT SYSTEM DIAGRAM.	
Function		Cooling	Heating	
Capacity Rated (Min.-Max.) *2	kW	3.3 (1.1 - 3.8)	4.0 (1.0 - 4.1)	
Breaker capacity	A	15		
Electrical data	Power input (Total) *1, *2	W	850	910
	Running current (Total) *1, *2	A	4.3 - 4.1 - 3.9	4.6 - 4.4 - 4.2
	Power factor (Total) *1, *2	%	90	
	Starting current (Total) *1, *2	A	4.6	
Coefficient of performance (C.O.P) (Total) *1, *2			3.88	4.40
Compressor	Model	KVB073FYXMC		
	Output	W	470	
	Current *1, *2	A	3.8	
	Refrigeration oil (Model)	L	0.27 (FW68S)	
Fan motor	Model	RC0J50-FA		
	Current *1, *2	A	0.35	
Dimensions W x H x D		mm	800 x 550 x 285	
Weight		kg	33	
Special remarks	Air flow (Rated)	m ³ /h	1,890	1,938
	Sound level (Rated)	dB(A)	49	50
	Fan speed (Rated)	rpm	860	880
	Pre-charged refrigerant quantity (R32)	kg	1.0	
	Max refrigerant quantity (R32)	kg	1.0	

*1 Measured under rated operating frequency.

*2 When connected with indoor units below.

MSZ-AP15VF + MSZ-LN18VG

NOTE: Test conditions are based on ISO 5151. (Refrigerant piping length (one way): 5 m)

COOLING INDOOR Dry-bulb temperature 27.0 °C Wet-bulb temperature 19.0 °C

OUTDOOR Dry-bulb temperature 35.0 °C Wet-bulb temperature 24.0 °C

HEATING INDOOR Dry-bulb temperature 20.0 °C

OUTDOOR Dry-bulb temperature 7.0 °C Wet-bulb temperature 6.0 °C



Outdoor model			MXZ-2F33VF2	
Outdoor unit power supply			Single phase 220 - 230 - 240 V, 50 Hz	
System	Indoor units number		2	
	Piping total length	m	Max. 20	
	Connecting pipe length	m	Max. 15	
	Height difference (Indoor ~ Outdoor)	m	Refer to 8 REFRIGERANT SYSTEM DIAGRAM.	
	Height difference (Indoor ~ Indoor)	m	Refer to 8 REFRIGERANT SYSTEM DIAGRAM.	
Function			Cooling	Heating
Capacity Rated (Min.-Max.) *2		kW	3.3 (1.1 - 3.8)	4.0 (1.0 - 4.1)
Breaker capacity		A	15	
Electrical data	Power input (Total) *1, *2	W	850	910
	Running current (Total) *1, *2	A	4.3 - 4.1 - 3.9	4.6 - 4.4 - 4.2
	Power factor (Total) *1, *2	%	90	
	Starting current (Total) *1, *2	A	4.6	
Coefficient of performance (C.O.P) (Total) *1, *2			3.88	4.40
Compressor	Model		KVB073FYXMC	
	Output	W	470	
	Current *1, *2	A	3.8	
	Refrigeration oil (Model)	L	0.27 (FW68S)	
Fan motor	Model		RC0J50-NA	
	Current *1, *2	A	0.35	
Dimensions W x H x D		mm	800 x 550 x 285	
Weight		kg	33	
Special remarks	Air flow (Rated)	m ³ /h	1,890	1,938
	Sound level (Rated)	dB(A)	49	50
	Fan speed (Rated)	rpm	860	880
	Pre-charged refrigerant quantity (R32)	kg	1.0	
	Max refrigerant quantity (R32)	kg	1.0	

*1 Measured under rated operating frequency.

*2 When connected with indoor units below.

MSZ-AP15VG + MSZ-LN18VG

NOTE: Test conditions are based on ISO 5151. (Refrigerant piping length (one way): 5 m)

COOLING INDOOR Dry-bulb temperature 27.0 °C Wet-bulb temperature 19.0 °C

OUTDOOR Dry-bulb temperature 35.0 °C Wet-bulb temperature 24.0 °C

HEATING INDOOR Dry-bulb temperature 20.0 °C

OUTDOOR Dry-bulb temperature 7.0 °C Wet-bulb temperature 6.0 °C



Outdoor model			MXZ-2F33VF3	
Outdoor unit power supply			Single phase 220 - 230 - 240 V, 50 Hz	
System	Indoor units number		2	
	Piping total length	m	Max. 20	
	Connecting pipe length	m	Max. 15	
	Height difference (Indoor ~ Outdoor)	m	Refer to 8 REFRIGERANT SYSTEM DIAGRAM.	
	Height difference (Indoor ~ Indoor)	m	Refer to 8 REFRIGERANT SYSTEM DIAGRAM.	
Function			Cooling	Heating
Capacity Rated (Min.-Max.) *2		kW	3.3 (1.1 - 3.8)	4.0 (1.0 - 4.1)
Breaker capacity		A	15	
Electrical data	Power input (Total) *1, *2	W	850	910
	Running current (Total) *1, *2	A	4.3 - 4.1 - 3.9	4.6 - 4.4 - 4.2
	Power factor (Total) *1, *2	%	90	
	Starting current (Total) *1, *2	A	4.6	
Coefficient of performance (C.O.P) (Total) *1, *2			3.88	4.40
Compressor	Model		KVB073FYXMC	
	Output	W	470	
	Current *1, *2	A	3.8	
	Refrigeration oil (Model)	L	0.27 (FW68S)	
Fan motor	Model		RC0J50-NA	
	Current *1, *2	A	0.35	
Dimensions W x H x D		mm	800 x 550 x 285	
Weight		kg	33	
Special remarks	Air flow (Rated)	m ³ /h	1,890	1,938
	Sound level (Rated)	dB(A)	49	50
	Fan speed (Rated)	rpm	860	880
	Pre-charged refrigerant quantity (R32)	kg	0.8	
	Max refrigerant quantity (R32)	kg	0.8	

*1 Measured under rated operating frequency.

*2 When connected with indoor units below.

MSZ-AP15VG + MSZ-LN18VG2

NOTE: Test conditions are based on ISO 5151. (Refrigerant piping length (one way): 5 m)

COOLING INDOOR Dry-bulb temperature 27.0 °C Wet-bulb temperature 19.0 °C

OUTDOOR Dry-bulb temperature 35.0 °C Wet-bulb temperature 24.0 °C

HEATING INDOOR Dry-bulb temperature 20.0 °C

OUTDOOR Dry-bulb temperature 7.0 °C Wet-bulb temperature 6.0 °C



Outdoor model			MXZ-2F42VF	
Outdoor unit power supply			Single phase 220 - 230 - 240 V, 50 Hz	
System	Indoor units number		2	
	Piping total length	m	Max. 30	
	Connecting pipe length	m	Max. 20	
	Height difference (Indoor ~ Outdoor)	m	Refer to 8 REFRIGERANT SYSTEM DIAGRAM.	
	Height difference (Indoor ~ Indoor)	m	Refer to 8 REFRIGERANT SYSTEM DIAGRAM.	
Function			Cooling	Heating
Capacity Rated (Min.-Max.) *2		kW	4.2 (1.1 - 4.4)	4.5 (1.0 - 4.8)
Breaker capacity		A	15	
Electrical data	Power input (Total) *1, *2	W	980	880
	Running current (Total) *1, *2	A	4.9 - 4.7 - 4.5	4.4 - 4.3 - 4.1
	Power factor (Total) *1, *2	%	90	
	Starting current (Total) *1, *2	A	7.6	
Coefficient of performance (C.O.P) (Total) *1, *2			4.29	5.11
Compressor	Model		SVB130FBBMT	
	Output	W	1,100	
	Current *1, *2	A	3.99	
	Refrigeration oil (Model)	L	0.35 (FW68S)	
Fan motor	Model		RC0J50-FA	
	Current *1, *2	A	0.35	
Dimensions W x H x D		mm	800 x 550 x 285	
Weight		kg	37	
Special remarks	Air flow (Rated)	m ³ /h	1,704	2,010
	Sound level (Rated)	dB(A)	44	50
	Fan speed (Rated)	rpm	780	910
	Pre-charged refrigerant quantity (R32)	kg	1.2	
	Max refrigerant quantity (R32)	kg	1.2	

*1 Measured under rated operating frequency.

*2 When connected with indoor units below.

MSZ-LN18VG + MSZ-LN25VG

NOTE: Test conditions are based on ISO 5151. (Refrigerant piping length (one way): 5 m)

COOLING INDOOR Dry-bulb temperature 27.0 °C Wet-bulb temperature 19.0 °C

OUTDOOR Dry-bulb temperature 35.0 °C Wet-bulb temperature 24.0 °C

HEATING INDOOR Dry-bulb temperature 20.0 °C

OUTDOOR Dry-bulb temperature 7.0 °C Wet-bulb temperature 6.0 °C

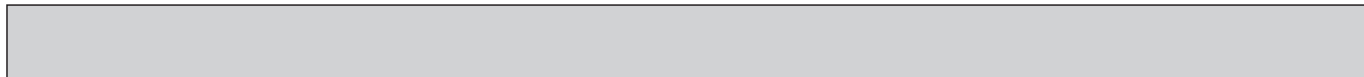

Outdoor model			MXZ-2F42VF2		
Outdoor unit power supply			Single phase 220 - 230 - 240 V, 50 Hz		
System	Indoor units number		2		
	Piping total length	m	Max. 30		
	Connecting pipe length	m	Max. 20		
	Height difference (Indoor ~ Outdoor)	m	Refer to 8 REFRIGERANT SYSTEM DIAGRAM.		
	Height difference (Indoor ~ Indoor)	m	Refer to 8 REFRIGERANT SYSTEM DIAGRAM.		
Function			Cooling	Heating	
Capacity Rated (Min.-Max.) *2		kW	4.2 (1.1 - 4.4)	4.5 (1.0 - 4.8)	
Breaker capacity		A	15		
Electrical data	Power input (Total) *1, *2		980	880	
	Running current (Total) *1, *2		4.9 - 4.7 - 4.5	4.4 - 4.3 - 4.1	
	Power factor (Total) *1, *2		90		
	Starting current (Total) *1, *2		7.6		
Coefficient of performance (C.O.P) (Total) *1, *2			4.29	5.11	
Compressor	Model		SVB130FBBMT		
	Output	W	1,100		
	Current *1, *2	A	3.99		
	Refrigeration oil (Model)	L	0.35 (FW68S)		
Fan motor	Model		RC0J50-NA		
	Current *1, *2	A	0.35		
Dimensions W x H x D		mm	800 x 550 x 285		
Weight		kg	37		
Special remarks	Air flow (Rated)		m ³ /h	1,704	2,010
	Sound level (Rated)		dB(A)	44	50
	Fan speed (Rated)		rpm	780	910
	Pre-charged refrigerant quantity (R32)		kg	1.2	
	Max refrigerant quantity (R32)		kg	1.2	

*1 Measured under rated operating frequency.

*2 When connected with indoor units below.

MSZ-LN18VG + MSZ-LN25VG

NOTE: Test conditions are based on ISO 5151. (Refrigerant piping length (one way): 5 m)

COOLING INDOOR Dry-bulb temperature 27.0 °C Wet-bulb temperature 19.0 °C

OUTDOOR Dry-bulb temperature 35.0 °C Wet-bulb temperature 24.0 °C

HEATING INDOOR Dry-bulb temperature 20.0 °C

OUTDOOR Dry-bulb temperature 7.0 °C Wet-bulb temperature 6.0 °C

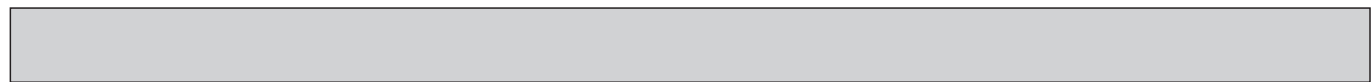

Outdoor model			MXZ-2F42VF3	
Outdoor unit power supply			Single phase 220 - 230 - 240 V, 50 Hz	
System	Indoor units number		2	
	Piping total length	m	Max. 30	
	Connecting pipe length	m	Max. 20	
	Height difference (Indoor ~ Outdoor)	m	Refer to 8 REFRIGERANT SYSTEM DIAGRAM.	
	Height difference (Indoor ~ Indoor)	m	Refer to 8 REFRIGERANT SYSTEM DIAGRAM.	
Function			Cooling	Heating
Capacity Rated (Min.-Max.) *2		kW	4.2 (1.1 - 4.4)	4.5 (1.0 - 4.8)
Breaker capacity		A	15	
Electrical data	Power input (Total) *1, *2	W	980	880
	Running current (Total) *1, *2	A	4.9 - 4.7 - 4.5	4.4 - 4.3 - 4.1
	Power factor (Total) *1, *2	%	90	
	Starting current (Total) *1, *2	A	7.6	
Coefficient of performance (C.O.P) (Total) *1, *2			4.29	5.11
Compressor	Model		SVB130FBBMT	
	Output	W	1,100	
	Current *1, *2	A	3.99	
	Refrigeration oil (Model)	L	0.35 (FW68S)	
Fan motor	Model		RC0J50-NA	
	Current *1, *2	A	0.35	
Dimensions W x H x D		mm	800 x 550 x 285	
Weight		kg	37	
Special remarks	Air flow (Rated)	m ³ /h	1,704	2,010
	Sound level (Rated)	dB(A)	44	50
	Fan speed (Rated)	rpm	780	910
	Pre-charged refrigerant quantity (R32)	kg	1.0	
	Max refrigerant quantity (R32)	kg	1.0	

*1 Measured under rated operating frequency.

*2 When connected with indoor units below.

MSZ-LN18VG2 + MSZ-LN25VG2

NOTE: Test conditions are based on ISO 5151. (Refrigerant piping length (one way): 5 m)

COOLING INDOOR Dry-bulb temperature 27.0 °C Wet-bulb temperature 19.0 °C

OUTDOOR Dry-bulb temperature 35.0 °C Wet-bulb temperature 24.0 °C

HEATING INDOOR Dry-bulb temperature 20.0 °C

OUTDOOR Dry-bulb temperature 7.0 °C Wet-bulb temperature 6.0 °C

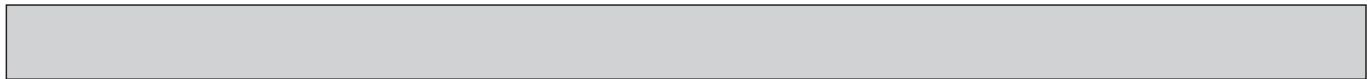

Outdoor model			MXZ-2F53VF2 MXZ-2F53VFH2	
Outdoor unit power supply			Single phase 220 - 230 - 240 V, 50 Hz	
System	Indoor units number		2	
	Piping total length	m	Max. 30	
	Connecting pipe length	m	Max. 20	
	Height difference (Indoor ~ Outdoor)	m	Refer to 8 REFRIGERANT SYSTEM DIAGRAM.	
	Height difference (Indoor ~ Indoor)	m	Refer to 8 REFRIGERANT SYSTEM DIAGRAM.	
Function			Cooling	Heating
Capacity Rated (Min.-Max.) *2		kW	5.3 (1.1 - 5.6)	6.4 (1.0 - 7.0)
Breaker capacity		A	15	
Electrical data	Power input (Total) *1, *2	W	1,400	1,560
	Running current (Total) *1, *2	A	6.5 - 6.2 - 6.0	7.5 - 7.1 - 6.8
	Power factor (Total) *1, *2	%	97.5	95
	Starting current (Total) *1, *2	A	7.6	
Coefficient of performance (C.O.P) (Total) *1, *2			3.79	4.10
Compressor	Model		SVB130FBBMT	
	Output	W	1,400	
	Current *1, *2	A	6.59	
	Refrigeration oil (Model)	L	0.35 (FW68S)	
Fan motor	Model		RC0J50-NA	
	Current *1, *2	A	0.35	
Dimensions W x H x D		mm	800 x 550 x 285	
Weight		kg	MXZ-2F53VF2: 37 MXZ-2F53VFH2: 38	
Special remarks	Air flow (Rated)	m ³ /h	1,962	2,082
	Sound level (Rated)	dB(A)	46	51
	Fan speed (Rated)	rpm	890	940
	Pre-charged refrigerant quantity (R32)	kg	1.2	
	Max refrigerant quantity (R32)	kg	1.2	

*1 Measured under rated operating frequency.

*2 When connected with indoor units below.

MSZ-LN18VG + MSZ-LN35VG

NOTE: Test conditions are based on ISO 5151. (Refrigerant piping length (one way): 5 m)

COOLING INDOOR Dry-bulb temperature 27.0 °C Wet-bulb temperature 19.0 °C

OUTDOOR Dry-bulb temperature 35.0 °C Wet-bulb temperature 24.0 °C

HEATING INDOOR Dry-bulb temperature 20.0 °C

OUTDOOR Dry-bulb temperature 7.0 °C Wet-bulb temperature 6.0 °C



Outdoor model		MXZ-2F53VF3 MXZ-2F53VFH3		
Outdoor unit power supply		Single phase 220 - 230 - 240 V, 50 Hz		
System	Indoor units number	2		
	Piping total length	m	Max. 30	
	Connecting pipe length	m	Max. 20	
	Height difference (Indoor ~ Outdoor)	m	Refer to 8 REFRIGERANT SYSTEM DIAGRAM.	
	Height difference (Indoor ~ Indoor)	m	Refer to 8 REFRIGERANT SYSTEM DIAGRAM.	
Function		Cooling	Heating	
Capacity Rated (Min.-Max.) *2	kW	5.3 (1.1 - 5.6)	6.4 (1.0 - 7.0)	
Breaker capacity	A	15		
Electrical data	Power input (Total) *1, *2	W	1,400	1,560
	Running current (Total) *1, *2	A	6.5 - 6.2 - 6.0	7.5 - 7.1 - 6.8
	Power factor (Total) *1, *2	%	97.5	95
	Starting current (Total) *1, *2	A	7.6	
Coefficient of performance (C.O.P) (Total) *1, *2			3.79	4.10
Compressor	Model	SVB130FBBMT		
	Output	W	1,400	
	Current *1, *2	A	6.59	
	Refrigeration oil (Model)	L	0.35 (FW68S)	
Fan motor	Model	RC0J50-NA		
	Current *1, *2	A	0.35	
Dimensions W x H x D	mm	800 x 550 x 285		
Weight	kg	MXZ-2F53VF3: 37 MXZ-2F53VFH3: 38		
Special remarks	Air flow (Rated)	m ³ /h	1,962	2,082
	Sound level (Rated)	dB(A)	46	51
	Fan speed (Rated)	rpm	890	940
	Pre-charged refrigerant quantity (R32)	kg	1.0	
	Max refrigerant quantity (R32)	kg	1.0	

*1 Measured under rated operating frequency.

*2 When connected with indoor units below.

MSZ-LN18VG2 + MSZ-LN35VG2

NOTE: Test conditions are based on ISO 5151. (Refrigerant piping length (one way): 5 m)

COOLING INDOOR Dry-bulb temperature 27.0 °C Wet-bulb temperature 19.0 °C

OUTDOOR Dry-bulb temperature 35.0 °C Wet-bulb temperature 24.0 °C

HEATING INDOOR Dry-bulb temperature 20.0 °C

OUTDOOR Dry-bulb temperature 7.0 °C Wet-bulb temperature 6.0 °C



Outdoor model			MXZ-3F54VF	
Outdoor unit power supply			Single phase 220 - 230 - 240 V, 50 Hz	
System	Indoor units number		2 to 3	
	Piping total length	m	Max. 50	
	Connecting pipe length	m	Max. 25	
	Height difference (Indoor ~ Outdoor)	m	Refer to 8 REFRIGERANT SYSTEM DIAGRAM.	
	Height difference (Indoor ~ Indoor)	m	Refer to 8 REFRIGERANT SYSTEM DIAGRAM.	
Function			Cooling	Heating
Capacity Rated (Min.-Max.) *2		kW	5.4 (2.9 - 6.8)	7.0 (2.6 - 9.0)
Breaker capacity		A	25	
Electrical data	Power input (Total) *1, *2	W	1,320	1,400
	Running current (Total) *1, *2	A	6.0 - 5.7 - 5.5	6.4 - 6.1 - 5.9
	Power factor (Total) *1, *2	%	99	
	Starting current (Total) *1, *2	A	6.7	
Coefficient of performance (C.O.P) (Total) *1, *2			4.09	5.00
Compressor	Model		SVB130FBBM1T	
	Output	W	1,400	
	Current *1, *2	A	5.06	
	Refrigeration oil (Model)	L	0.6 (FW68S)	
Fan motor	Model		SIC-82FX-F764-1	
	Current *1, *2	A	0.5	
Dimensions W x H x D		mm	840 x 710 x 330	
Weight		kg	57	
Special remarks	Air flow (Rated)	m ³ /h	1,860	1,632
	Sound level (Rated)	dB(A)	46	50
	Fan speed (Rated)	rpm	600	560
	Pre-charged refrigerant quantity (R32)	kg	1.4	
	Max refrigerant quantity (R32)	kg	2.4	

*1 Measured under rated operating frequency.

*2 When connected with indoor units below.

MSZ-LN18VG + MSZ-LN18VG + MSZ-LN18VG

NOTE: Test conditions are based on ISO 5151. (Refrigerant piping length (one way): 5 m)

COOLING INDOOR Dry-bulb temperature 27.0 °C Wet-bulb temperature 19.0 °C

OUTDOOR Dry-bulb temperature 35.0 °C Wet-bulb temperature 24.0 °C

HEATING INDOOR Dry-bulb temperature 20.0 °C

OUTDOOR Dry-bulb temperature 7.0 °C Wet-bulb temperature 6.0 °C



Outdoor model			MXZ-3F54VF2		
Outdoor unit power supply			Single phase 220 - 230 - 240 V, 50 Hz		
System	Indoor units number		2 to 3		
	Piping total length	m	Max. 50		
	Connecting pipe length	m	Max. 25		
	Height difference (Indoor ~ Outdoor)	m	Refer to 8 REFRIGERANT SYSTEM DIAGRAM.		
	Height difference (Indoor ~ Indoor)	m	Refer to 8 REFRIGERANT SYSTEM DIAGRAM.		
Function			Cooling	Heating	
Capacity Rated (Min.-Max.) *2		kW	5.4 (2.9 - 6.8)	7.0 (2.6 - 9.0)	
Breaker capacity		A	25		
Electrical data	Power input (Total) *1, *2		W	1,320	1,400
	Running current (Total) *1, *2		A	6.0 - 5.7 - 5.5	6.4 - 6.1 - 5.9
	Power factor (Total) *1, *2		%	99	
	Starting current (Total) *1, *2		A	6.7	
Coefficient of performance (C.O.P) (Total) *1, *2			4.09	5.00	
Compressor	Model		SVB130FBBM1T		
	Output	W	1,400		
	Current *1, *2	A	5.06		
	Refrigeration oil (Model)	L	0.6 (FW68S)		
Fan motor	Model		SIC-82FX-F764-1		
	Current *1, *2	A	0.5		
Dimensions W x H x D		mm	840 x 710 x 330		
Weight		kg	58		
Special remarks	Air flow (Rated)		m ³ /h	1,860	1,860
	Sound level (Rated)		dB(A)	46	50
	Fan speed (Rated)		rpm	600	600
	Pre-charged refrigerant quantity (R32)		kg	2.4	
	Max refrigerant quantity (R32)		kg	2.4	

*1 Measured under rated operating frequency.

*2 When connected with indoor units below.

MSZ-LN18VG + MSZ-LN18VG + MSZ-LN18VG

NOTE: Test conditions are based on ISO 5151. (Refrigerant piping length (one way): 5 m)

COOLING INDOOR Dry-bulb temperature 27.0 °C Wet-bulb temperature 19.0 °C

OUTDOOR Dry-bulb temperature 35.0 °C Wet-bulb temperature 24.0 °C

HEATING INDOOR Dry-bulb temperature 20.0 °C

OUTDOOR Dry-bulb temperature 7.0 °C Wet-bulb temperature 6.0 °C



Outdoor model			MXZ-3F54VF3	
Outdoor unit power supply			Single phase 220 - 230 - 240 V, 50 Hz	
System	Indoor units number		2 to 3	
	Piping total length	m	Max. 50	
	Connecting pipe length	m	Max. 25	
	Height difference (Indoor ~ Outdoor)	m	Refer to 8 REFRIGERANT SYSTEM DIAGRAM.	
	Height difference (Indoor ~ Indoor)	m	Refer to 8 REFRIGERANT SYSTEM DIAGRAM.	
Function			Cooling	Heating
Capacity Rated (Min.-Max.) *2		kW	5.4 (2.9 - 6.8)	7.0 (2.6 - 9.0)
Breaker capacity		A	25	
Electrical data	Power input (Total) *1, *2	W	1,320	1,400
	Running current (Total) *1, *2	A	6.0 - 5.7 - 5.5	6.4 - 6.1 - 5.9
	Power factor (Total) *1, *2	%	99	
	Starting current (Total) *1, *2	A	6.7	
Coefficient of performance (C.O.P) (Total) *1, *2			4.09	5.00
Compressor	Model		SVB130FBBM1T	
	Output	W	1,400	
	Current *1, *2	A	5.06	
	Refrigeration oil (Model)	L	0.6 (FW68S)	
Fan motor	Model		SIC-82FX-F764-1	
	Current *1, *2	A	0.5	
Dimensions W x H x D		mm	840 x 710 x 330	
Weight		kg	58	
Special remarks	Air flow (Rated)	m ³ /h	1,860	1,860
	Sound level (Rated)	dB(A)	46	50
	Fan speed (Rated)	rpm	600	600
	Pre-charged refrigerant quantity (R32)	kg	2.4	
	Max refrigerant quantity (R32)	kg	2.4	

*1 Measured under rated operating frequency.

*2 When connected with indoor units below.

MSZ-LN18VG2 + MSZ-LN18VG2 + MSZ-LN18VG2

NOTE: Test conditions are based on ISO 5151. (Refrigerant piping length (one way): 5 m)

COOLING INDOOR Dry-bulb temperature 27.0 °C Wet-bulb temperature 19.0 °C

OUTDOOR Dry-bulb temperature 35.0 °C Wet-bulb temperature 24.0 °C

HEATING INDOOR Dry-bulb temperature 20.0 °C

OUTDOOR Dry-bulb temperature 7.0 °C Wet-bulb temperature 6.0 °C



Outdoor model			MXZ-3F68VF		
Outdoor unit power supply			Single phase 220 - 230 - 240 V, 50 Hz		
System	Indoor units number		2 to 3		
	Piping total length	m	Max. 60		
	Connecting pipe length	m	Max. 25		
	Height difference (Indoor ~ Outdoor)	m	Refer to 8 REFRIGERANT SYSTEM DIAGRAM.		
	Height difference (Indoor ~ Indoor)	m	Refer to 8 REFRIGERANT SYSTEM DIAGRAM.		
Function			Cooling	Heating	
Capacity Rated (Min.-Max.) *2		kW	6.8 (2.9 - 8.4)	8.6 (2.6 - 10.6)	
Breaker capacity		A	25		
Electrical data	Power input (Total) *1, *2		W	1,840	1,910
	Running current (Total) *1, *2		A	8.4 - 8.0 - 7.7	8.8 - 8.4 - 8.0
	Power factor (Total) *1, *2		%	99	
	Starting current (Total) *1, *2		A	10.1	
Coefficient of performance (C.O.P) (Total) *1, *2			3.70	4.50	
Compressor	Model		SVB172FCKM1T		
	Output	W	1,800		
	Current *1, *2	A	8.58		
	Refrigeration oil (Model)	L	0.6 (FW68S)		
Fan motor	Model		SIC-82FX-F764-1		
	Current *1, *2	A	0.5		
Dimensions W x H x D		mm	840 x 710 x 330		
Weight		kg	57		
Special remarks	Air flow (Rated)		m ³ /h	2,124	2,376
	Sound level (Rated)		dB(A)	48	53
	Fan speed (Rated)		rpm	650	700
	Pre-charged refrigerant quantity (R32)		kg	1.4	
	Max refrigerant quantity (R32)		kg	2.4	

*1 Measured under rated operating frequency.

*2 When connected with indoor units below.

MSZ-LN18VG + MSZ-LN25VG + MSZ-LN25VG

NOTE: Test conditions are based on ISO 5151. (Refrigerant piping length (one way): 5 m)

COOLING INDOOR Dry-bulb temperature 27.0 °C Wet-bulb temperature 19.0 °C

OUTDOOR Dry-bulb temperature 35.0 °C Wet-bulb temperature 24.0 °C

HEATING INDOOR Dry-bulb temperature 20.0 °C

OUTDOOR Dry-bulb temperature 7.0 °C Wet-bulb temperature 6.0 °C

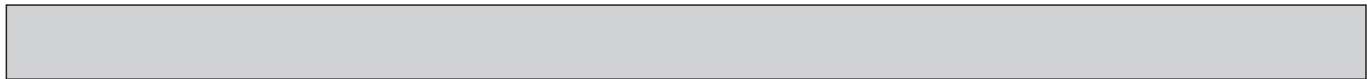

Outdoor model			MXZ-3F68VF2	
Outdoor unit power supply			Single phase 220 - 230 - 240 V, 50 Hz	
System	Indoor units number		2 to 3	
	Piping total length	m	Max. 60	
	Connecting pipe length	m	Max. 25	
	Height difference (Indoor ~ Outdoor)	m	Refer to 8 REFRIGERANT SYSTEM DIAGRAM.	
	Height difference (Indoor ~ Indoor)	m	Refer to 8 REFRIGERANT SYSTEM DIAGRAM.	
Function			Cooling	Heating
Capacity Rated (Min.-Max.) *2		kW	6.8 (2.9 - 8.4)	8.6 (2.6 - 10.6)
Breaker capacity		A	25	
Electrical data	Power input (Total) *1, *2	W	1,840	1,910
	Running current (Total) *1, *2	A	8.4 - 8.0 - 7.7	8.8 - 8.4 - 8.0
	Power factor (Total) *1, *2	%	99	
	Starting current (Total) *1, *2	A	10.1	
Coefficient of performance (C.O.P) (Total) *1, *2			3.70	4.50
Compressor	Model		SVB172FCKM1T	
	Output	W	1,800	
	Current *1, *2	A	8.58	
	Refrigeration oil (Model)	L	0.6 (FW68S)	
Fan motor	Model		SIC-82FX-F764-1	
	Current *1, *2	A	0.5	
Dimensions W x H x D		mm	840 x 710 x 330	
Weight		kg	58	
Special remarks	Air flow (Rated)	m ³ /h	2,124	2,376
	Sound level (Rated)	dB(A)	48	53
	Fan speed (Rated)	rpm	650	700
	Pre-charged refrigerant quantity (R32)	kg	2.4	
	Max refrigerant quantity (R32)	kg	2.4	

*1 Measured under rated operating frequency.

*2 When connected with indoor units below.

MSZ-LN18VG + MSZ-LN25VG + MSZ-LN25VG

NOTE: Test conditions are based on ISO 5151. (Refrigerant piping length (one way): 5 m)

COOLING INDOOR Dry-bulb temperature 27.0 °C Wet-bulb temperature 19.0 °C

OUTDOOR Dry-bulb temperature 35.0 °C Wet-bulb temperature 24.0 °C

HEATING INDOOR Dry-bulb temperature 20.0 °C

OUTDOOR Dry-bulb temperature 7.0 °C Wet-bulb temperature 6.0 °C



Outdoor model			MXZ-3F68VF3	
Outdoor unit power supply			Single phase 220 - 230 - 240 V, 50 Hz	
System	Indoor units number		2 to 3	
	Piping total length	m	Max. 60	
	Connecting pipe length	m	Max. 25	
	Height difference (Indoor ~ Outdoor)	m	Refer to 8 REFRIGERANT SYSTEM DIAGRAM.	
	Height difference (Indoor ~ Indoor)	m	Refer to 8 REFRIGERANT SYSTEM DIAGRAM.	
Function			Cooling	Heating
Capacity Rated (Min.-Max.) *2		kW	6.8 (2.9 - 8.4)	8.6 (2.6 - 10.6)
Breaker capacity		A	25	
Electrical data	Power input (Total) *1, *2		1,840	1,910
	Running current (Total) *1, *2		8.4 - 8.0 - 7.7	8.8 - 8.4 - 8.0
	Power factor (Total) *1, *2		99	
	Starting current (Total) *1, *2		10.1	
Coefficient of performance (C.O.P) (Total) *1, *2			3.70	4.50
Compressor	Model		SVB172FCKM1T	
	Output	W	1,800	
	Current *1, *2	A	8.58	
	Refrigeration oil (Model)	L	0.6 (FW68S)	
Fan motor	Model		SIC-82FX-F764-1	
	Current *1, *2	A	0.5	
Dimensions W x H x D		mm	840 x 710 x 330	
Weight		kg	58	
Special remarks	Air flow (Rated)		2,124	2,376
	Sound level (Rated)		48	53
	Fan speed (Rated)		650	700
	Pre-charged refrigerant quantity (R32)		2.4	
	Max refrigerant quantity (R32)		2.4	

*1 Measured under rated operating frequency.

*2 When connected with indoor units below.

MSZ-LN18VG2 + MSZ-LN25VG2 + MSZ-LN25VG2

NOTE: Test conditions are based on ISO 5151. (Refrigerant piping length (one way): 5 m)

COOLING INDOOR Dry-bulb temperature 27.0 °C Wet-bulb temperature 19.0 °C

OUTDOOR Dry-bulb temperature 35.0 °C Wet-bulb temperature 24.0 °C

HEATING INDOOR Dry-bulb temperature 20.0 °C

OUTDOOR Dry-bulb temperature 7.0 °C Wet-bulb temperature 6.0 °C

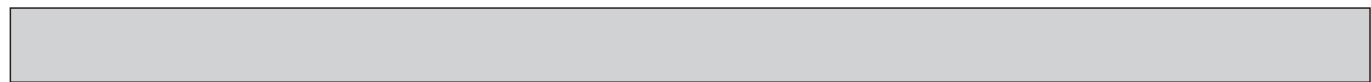

Outdoor model			MXZ-4F72VF	
Outdoor unit power supply			Single phase 220 - 230 - 240 V, 50 Hz	
System	Indoor units number		2 to 4	
	Piping total length	m	Max. 60	
	Connecting pipe length	m	Max. 25	
	Height difference (Indoor ~ Outdoor)	m	Refer to 8 REFRIGERANT SYSTEM DIAGRAM.	
	Height difference (Indoor ~ Indoor)	m	Refer to 8 REFRIGERANT SYSTEM DIAGRAM.	
Function			Cooling	Heating
Capacity Rated (Min.-Max.) *2		kW	7.2 (3.7 - 8.8)	8.6 (3.4 - 10.7)
Breaker capacity		A	25	
Electrical data	Power input (Total) *1, *2	W	1,850	1,870
	Running current (Total) *1, *2	A	8.5 - 8.1 - 7.8	8.6 - 8.2 - 7.9
	Power factor (Total) *1, *2	%	99	
	Starting current (Total) *1, *2	A	10.1	
Coefficient of performance (C.O.P) (Total) *1, *2			3.89	4.60
Compressor	Model		SVB172FCKM1T	
	Output	W	2,000	
	Current *1, *2	A	6.98	
	Refrigeration oil (Model)	L	0.6 (FW68S)	
Fan motor	Model		SIC-82FX-F764-1	
	Current *1, *2	A	0.5	
Dimensions W x H x D		mm	840 x 710 x 330	
Weight		kg	58	
Special remarks	Air flow (Rated)	m ³ /h	2,124	2,562
	Sound level (Rated)	dB(A)	48	54
	Fan speed (Rated)	rpm	650	740
	Pre-charged refrigerant quantity (R32)	kg	1.4	
	Max refrigerant quantity (R32)	kg	2.4	

*1 Measured under rated operating frequency.

*2 When connected with indoor units below.

MSZ-LN18VG + MSZ-LN18VG + MSZ-LN18VG + MSZ-LN18VG

NOTE: Test conditions are based on ISO 5151. (Refrigerant piping length (one way): 5 m)

COOLING INDOOR Dry-bulb temperature 27.0 °C Wet-bulb temperature 19.0 °C

OUTDOOR Dry-bulb temperature 35.0 °C Wet-bulb temperature 24.0 °C

HEATING INDOOR Dry-bulb temperature 20.0 °C

OUTDOOR Dry-bulb temperature 7.0 °C Wet-bulb temperature 6.0 °C



Outdoor model		MXZ-4F72VF2	
Outdoor unit power supply		Single phase 220 - 230 - 240 V, 50 Hz	
System	Indoor units number	2 to 4	
	Piping total length	m	Max. 60
	Connecting pipe length	m	Max. 25
	Height difference (Indoor ~ Outdoor)	m	Refer to 8 REFRIGERANT SYSTEM DIAGRAM.
	Height difference (Indoor ~ Indoor)	m	Refer to 8 REFRIGERANT SYSTEM DIAGRAM.
Function		Cooling	Heating
Capacity Rated (Min.-Max.) *2	kW	7.2 (3.7 - 8.8)	8.6 (3.4 - 10.7)
Breaker capacity		A	25
Electrical data	Power input (Total) *1, *2	W	1,850
	Running current (Total) *1, *2	A	8.5 - 8.1 - 7.8
	Power factor (Total) *1, *2	%	99
	Starting current (Total) *1, *2	A	10.1
Coefficient of performance (C.O.P) (Total) *1, *2		3.89	4.60
Compressor	Model	SVB172FCKM1T	
	Output	W	2,000
	Current *1, *2	A	6.98
	Refrigeration oil (Model)	L	0.6 (FW68S)
Fan motor	Model	SIC-82FX-F764-1	
	Current *1, *2	A	0.5
Dimensions W x H x D		mm	840 x 710 x 330
Weight		kg	59
Special remarks	Air flow (Rated)	m ³ /h	2,124
	Sound level (Rated)	dB(A)	48
	Fan speed (Rated)	rpm	650
	Pre-charged refrigerant quantity (R32)	kg	2.4
	Max refrigerant quantity (R32)	kg	2.4

*1 Measured under rated operating frequency.

*2 When connected with indoor units below.

MSZ-LN18VG + MSZ-LN18VG + MSZ-LN18VG + MSZ-LN18VG

NOTE: Test conditions are based on ISO 5151. (Refrigerant piping length (one way): 5 m)

COOLING INDOOR Dry-bulb temperature 27.0 °C Wet-bulb temperature 19.0 °C

OUTDOOR Dry-bulb temperature 35.0 °C Wet-bulb temperature 24.0 °C

HEATING INDOOR Dry-bulb temperature 20.0 °C

OUTDOOR Dry-bulb temperature 7.0 °C Wet-bulb temperature 6.0 °C

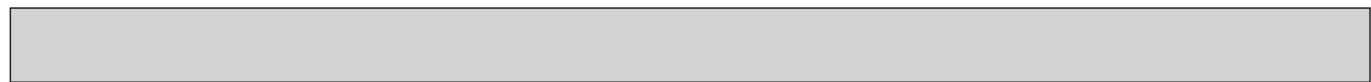

Outdoor model			MXZ-4F72VF3	
Outdoor unit power supply			Single phase 220 - 230 - 240 V, 50 Hz	
System	Indoor units number		2 to 4	
	Piping total length	m	Max. 60	
	Connecting pipe length	m	Max. 25	
	Height difference (Indoor ~ Outdoor)	m	Refer to 8 REFRIGERANT SYSTEM DIAGRAM.	
	Height difference (Indoor ~ Indoor)	m	Refer to 8 REFRIGERANT SYSTEM DIAGRAM.	
Function			Cooling	Heating
Capacity Rated (Min.-Max.) *2		kW	7.2 (3.7 - 8.8)	8.6 (3.4 - 10.7)
Breaker capacity		A	25	
Electrical data	Power input (Total) *1, *2	W	1,850	1,870
	Running current (Total) *1, *2	A	8.5 - 8.1 - 7.8	8.6 - 8.2 - 7.9
	Power factor (Total) *1, *2	%	99	
	Starting current (Total) *1, *2	A	10.1	
Coefficient of performance (C.O.P) (Total) *1, *2			3.89	4.60
Compressor	Model		SVB172FCKM1T	
	Output	W	2,000	
	Current *1, *2	A	6.98	
	Refrigeration oil (Model)	L	0.6 (FW68S)	
Fan motor	Model		SIC-82FX-F764-1	
	Current *1, *2	A	0.5	
Dimensions W x H x D		mm	840 x 710 x 330	
Weight		kg	59	
Special remarks	Air flow (Rated)	m ³ /h	2,124	2,562
	Sound level (Rated)	dB(A)	48	54
	Fan speed (Rated)	rpm	650	740
	Pre-charged refrigerant quantity (R32)	kg	2.4	
	Max refrigerant quantity (R32)	kg	2.4	

*1 Measured under rated operating frequency.

*2 When connected with indoor units below.

MSZ-LN18VG2 + MSZ-LN18VG2 + MSZ-LN18VG2 + MSZ-LN18VG2

NOTE: Test conditions are based on ISO 5151. (Refrigerant piping length (one way): 5 m)

COOLING INDOOR Dry-bulb temperature 27.0 °C Wet-bulb temperature 19.0 °C

OUTDOOR Dry-bulb temperature 35.0 °C Wet-bulb temperature 24.0 °C

HEATING INDOOR Dry-bulb temperature 20.0 °C

OUTDOOR Dry-bulb temperature 7.0 °C Wet-bulb temperature 6.0 °C



Outdoor model			MXZ-4F80VF2	
Outdoor unit power supply			Single phase 220 - 230 - 240 V, 50 Hz	
System	Indoor units number		2 to 4	
	Piping total length	m	Max. 60	
	Connecting pipe length	m	Max. 25	
	Height difference (Indoor ~ Outdoor)	m	Refer to 8 REFRIGERANT SYSTEM DIAGRAM.	
	Height difference (Indoor ~ Indoor)	m	Refer to 8 REFRIGERANT SYSTEM DIAGRAM.	
Function			Cooling	Heating
Capacity Rated (Min.-Max.) *2		kW	8.0 (3.7 - 9.0)	8.8 (3.4 - 11.0)
Breaker capacity		A	25	
Electrical data	Power input (Total) *1, *2	W	2,250	2,000
	Running current (Total) *1, *2	A	10.3 - 9.9 - 9.5	9.2 - 8.8 - 8.4
	Power factor (Total) *1, *2	%	99	
	Starting current (Total) *1, *2	A	10.1	
Coefficient of performance (C.O.P) (Total) *1, *2			3.56	4.40
Compressor	Model		SVB172FCKM1T	
	Output	W	2,000	
	Current *1, *2	A	6.98	
	Refrigeration oil (Model)	L	0.6 (FW68S)	
Fan motor	Model		SIC-82FX-F764-1	
	Current *1, *2	A	0.5	
Dimensions W x H x D		mm	840 x 710 x 330	
Weight		kg	59	
Special remarks	Air flow (Rated)	m ³ /h	2,418	2,646
	Sound level (Rated)	dB(A)	50	55
	Fan speed (Rated)	rpm	710	760
	Pre-charged refrigerant quantity (R32)	kg	2.4	
	Max refrigerant quantity (R32)	kg	2.4	

*1 Measured under rated operating frequency.

*2 When connected with indoor units below.

MSZ-LN18VG + MSZ-LN18VG + MSZ-LN18VG + MSZ-LN25VG

NOTE: Test conditions are based on ISO 5151. (Refrigerant piping length (one way): 5 m)

COOLING INDOOR Dry-bulb temperature 27.0 °C Wet-bulb temperature 19.0 °C

OUTDOOR Dry-bulb temperature 35.0 °C Wet-bulb temperature 24.0 °C

HEATING INDOOR Dry-bulb temperature 20.0 °C

OUTDOOR Dry-bulb temperature 7.0 °C Wet-bulb temperature 6.0 °C



Outdoor model			MXZ-4F80VF3	
Outdoor unit power supply			Single phase 220 - 230 - 240 V, 50 Hz	
System	Indoor units number		2 to 4	
	Piping total length	m	Max. 60	
	Connecting pipe length	m	Max. 25	
	Height difference (Indoor ~ Outdoor)	m	Refer to 8 REFRIGERANT SYSTEM DIAGRAM.	
	Height difference (Indoor ~ Indoor)	m	Refer to 8 REFRIGERANT SYSTEM DIAGRAM.	
Function			Cooling	Heating
Capacity Rated (Min.-Max.) *2		kW	8.0 (3.7 - 9.0)	8.8 (3.4 - 11.0)
Breaker capacity		A	25	
Electrical data	Power input (Total) *1, *2	W	2,250	2,000
	Running current (Total) *1, *2	A	10.3 - 9.9 - 9.5	9.2 - 8.8 - 8.4
	Power factor (Total) *1, *2	%	99	
	Starting current (Total) *1, *2	A	10.1	
Coefficient of performance (C.O.P) (Total) *1, *2			3.56	4.40
Compressor	Model		SVB172FCKM1T	
	Output	W	2,000	
	Current *1, *2	A	6.98	
	Refrigeration oil (Model)	L	0.6 (FW68S)	
Fan motor	Model		SIC-82FX-F764-1	
	Current *1, *2	A	0.5	
Dimensions W x H x D		mm	840 x 710 x 330	
Weight		kg	59	
Special remarks	Air flow (Rated)	m ³ /h	2,418	2,646
	Sound level (Rated)	dB(A)	50	55
	Fan speed (Rated)	rpm	710	760
	Pre-charged refrigerant quantity (R32)	kg	2.4	
	Max refrigerant quantity (R32)	kg	2.4	

*1 Measured under rated operating frequency.

*2 When connected with indoor units below.

MSZ-LN18VG2 + MSZ-LN18VG2 + MSZ-LN18VG2 + MSZ-LN25VG2

NOTE: Test conditions are based on ISO 5151. (Refrigerant piping length (one way): 5 m)

COOLING INDOOR Dry-bulb temperature 27.0 °C Wet-bulb temperature 19.0 °C

OUTDOOR Dry-bulb temperature 35.0 °C Wet-bulb temperature 24.0 °C

HEATING INDOOR Dry-bulb temperature 20.0 °C

OUTDOOR Dry-bulb temperature 7.0 °C Wet-bulb temperature 6.0 °C



Outdoor model		MXZ-4F83VF		
Outdoor unit power supply		Single phase 220 -230 - 240 V, 50 Hz *3		
System	Indoor units number	1 to 4 *4		
	Piping total length	m	Max. 70	
	Connecting pipe length	m	Max. 25	
	Height difference (Indoor ~ Outdoor)	m	Refer to 8 REFRIGERANT SYSTEM DIAGRAM.	
	Height difference (Indoor ~ Indoor)	m	Refer to 8 REFRIGERANT SYSTEM DIAGRAM.	
Function		Cooling	Heating	
Capacity Rated (Min.-Max.) *2	kW	8.3 (3.7 - 9.2)	9.3 (3.4 - 11.6)	
Breaker capacity	A	25		
Electrical data	Power input (Total) *1, *2	W	1,970	2,000
	Running current (Total) *1, *2	A	9.1 - 8.7 - 8.3	9.2 - 8.8 - 8.4
	Power factor (Total) *1, *2	%	99	
	Starting current (Total) *1, *2	A	8.8	
Coefficient of performance (C.O.P) (Total) *1, *2			4.21	4.65
Compressor	Model	SVB220FUGMC-L1		
	Output	W	2,200	
	Current *1, *2	A	7.4	7.5
	Refrigeration oil (Model)	L	0.6 (FW68CA)	
Fan motor	Model	SIC-88FWJ-D888-4		
	Current *1, *2	A	0.3	
Dimensions W x H x D		mm	950 x 796 x 330	
Weight		kg	62	
Special remarks	Air flow (Rated)	m ³ /h	3,420	3,720
	Sound level (Rated)	dB(A)	49	51
	Fan speed (Rated)	rpm	600	640
	Pre-charged refrigerant quantity (R32)	kg	2.4	
	Max refrigerant quantity (R32)	kg	2.4	

*1 Measured under rated operating frequency.

*2 When connected with below indoor units below.

MSZ-LN18VG2 + MSZ-LN18VG2 + MSZ-LN25VG2 + MSZ-LN25VG2

*3 220 and 240 V are only -[E1].

*4 At least 2 indoor units must be connected when using indoor unit with capacity lower than 25 class.

NOTE: Test conditions are based on ISO 5151. (Refrigerant piping length (one way): 5 m)

COOLING INDOOR Dry-bulb temperature 27.0°C Wet-bulb temperature 19.0°C

OUTDOOR Dry-bulb temperature 35.0°C Wet-bulb temperature 24.0°C

HEATING INDOOR Dry-bulb temperature 20.0°C

OUTDOOR Dry-bulb temperature 7.0°C Wet-bulb temperature 6.0°C

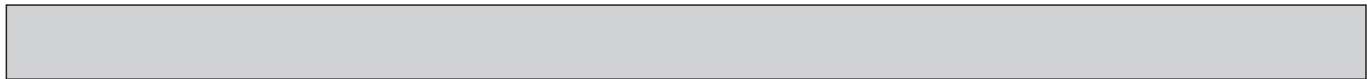

Outdoor model			MXZ-5F102VF	
Outdoor unit power supply			Single phase 220 -230 - 240 V, 50 Hz *3	
System	Indoor units number		1 to 5 *4	
	Piping total length	m	Max. 80	
	Connecting pipe length	m	Max. 25	
	Height difference (Indoor ~ Outdoor)	m	Refer to 8 REFRIGERANT SYSTEM DIAGRAM.	
	Height difference (Indoor ~ Indoor)	m	Refer to 8 REFRIGERANT SYSTEM DIAGRAM.	
Function			Cooling	Heating
Capacity Rated (Min.-Max.) *2		kW	10.2 (3.9 - 11.0)	10.5 (4.1 - 14.0)
Breaker capacity		A	25	
Electrical data	Power input (Total) *1, *2	W	2,800	2,280
	Running current (Total) *1, *2	A	12.9 - 12.3 - 11.8	10.5 - 10.0 - 9.6
	Power factor (Total) *1, *2	%	99	
	Starting current (Total) *1, *2	A	12.3	
Coefficient of performance (C.O.P) (Total) *1, *2			3.64	4.60
Compressor	Model		SVB220FUGMC-L1	
	Output	W	2,800	
	Current *1, *2	A	10.7	8.4
	Refrigeration oil (Model)	L	0.6 (FW68CA)	
Fan motor	Model		SIC-88FWJ-D888-4	
	Current *1, *2	A	0.3	
Dimensions W x H x D		mm	950 x 796 x 330	
Weight		kg	62	
Special remarks	Air flow (Rated)	m ³ /h	3,780	4,500
	Sound level (Rated)	dB(A)	52	56
	Fan speed (Rated)	rpm	650	750
	Pre-charged refrigerant quantity (R32)	kg	2.4	
	Max refrigerant quantity (R32)	kg	2.4	

*1 Measured under rated operating frequency.

*2 When connected with below indoor units below.

MSZ-LN18VG2 + MSZ-LN18VG2 + MSZ-LN18VG2 + MSZ-LN25VG2 + MSZ-LN25VG2

*3 220 and 240 V are only -E1.

*4 At least 2 indoor units must be connected when using indoor unit with capacity lower than 25 class.

NOTE: Test conditions are based on ISO 5151. (Refrigerant piping length (one way): 5 m)

COOLING INDOOR Dry-bulb temperature 27.0°C Wet-bulb temperature 19.0°C

OUTDOOR Dry-bulb temperature 35.0°C Wet-bulb temperature 24.0°C

HEATING INDOOR Dry-bulb temperature 20.0°C

OUTDOOR Dry-bulb temperature 7.0°C Wet-bulb temperature 6.0°C

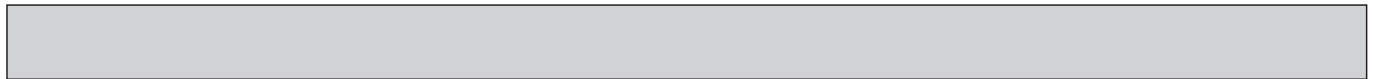

Outdoor model		MXZ-6F122VF		
Outdoor unit power supply		Single phase 220 - 230 - 240V, 50 Hz *3		
System	Indoor units number	1 to 6 *4		
	Piping total length	m	Max. 80	
	Connecting pipe length	m	Max. 25	
	Height difference (Indoor ~ Outdoor)	m	Refer to 8 REFRIGERANT SYSTEM DIAGRAM.	
	Height difference (Indoor ~ Indoor)	m	Refer to 8 REFRIGERANT SYSTEM DIAGRAM.	
Function		Cooling	Heating	
Capacity Rated (Min.-Max.) *2	kW	12.2 (3.5 - 14.0)	14.0 (3.5 - 16.5)	
Breaker capacity	A	32		
Electrical data	Power input (Total) *1, *2	W	3,660	3,310
	Running current (Total) *1, *2	A	16.8 - 16.1 - 15.4	15.2 - 14.5 - 13.9
	Power factor (Total) *1, *2	%	99	
	Starting current (Total) *1, *2	A	16.1	
Coefficient of performance (C.O.P) (Total) *1, *2			3.33	4.23
Compressor	Model	MVB33FBFMC		
	Output	W	3,300	
	Current *1, *2	A	14.2	12.6
	Refrigeration oil (Model)	L	1.10 (FW68CA)	
Fan motor	Model	SIC-88FWJ-D888-4		
	Current *1, *2	A	0.3	
Dimensions W x H x D		mm	950 x 1,048 x 330	
Weight		kg	87	
Special remarks	Air flow (Rated)	m ³ /h	3,780	4,620
	Sound level (Rated)	dB(A)	55	57
	Fan speed (Rated)	rpm	650	770
	Pre-charged refrigerant quantity (R32)	kg	2.4	
	Refrigerant filling capacity (R32)	kg	2.4	

*1 Measured under rated operating frequency.

*2 When connected with indoor units below.

MSZ-LN18VG2 + MSZ-LN18VG2 + MSZ-LN18VG2 + MSZ-LN18VG2 + MSZ-LN25VG2 + MSZ-LN25VG2

*3 220 and 240 V are only -[E1].

*4 At least 2 indoor units must be connected when using indoor unit with capacity lower than 25 class.

NOTE: Test conditions are based on ISO 5151. (Refrigerant piping length (one way): 5 m)

COOLING INDOOR Dry-bulb temperature 27.0 °C Wet-bulb temperature 19.0 °C

OUTDOOR Dry-bulb temperature 35.0 °C Wet-bulb temperature 24.0 °C

HEATING INDOOR Dry-bulb temperature 20.0 °C

OUTDOOR Dry-bulb temperature 7.0 °C Wet-bulb temperature 6.0 °C



Outdoor model			MXZ-2F53VFHZ	
Outdoor unit power supply			Single phase 220 -230 - 240 V, 50 Hz	
System	Indoor units number		1 to 2 *3	
	Piping total length	m	Max. 30	
	Connecting pipe length	m	Max. 20	
	Height difference (Indoor ~ Outdoor)	m	Refer to 8 REFRIGERANT SYSTEM DIAGRAM.	
	Height difference (Indoor ~ Indoor)	m	Refer to 8 REFRIGERANT SYSTEM DIAGRAM.	
Function			Cooling	Heating
Capacity Rated (Min.-Max.) *2		kW	5.3 (1.1 - 6.0)	6.4 (1.0 - 7.0)
Breaker capacity		A	16	
Electrical data	Power input (Total) *1, *2	W	1,290	1,360
	Running current (Total) *1, *2	A	5.9 - 5.7 - 5.4	6.2 - 6.0 - 5.7
	Power factor (Total) *1, *2	%	99	
	Starting current (Total) *1, *2	A	6.0	
Coefficient of performance (C.O.P) (Total) *1, *2			4.11	4.71
Compressor	Model		SVB220FUGMC-L1	
	Output	W	1,400	
	Current *1, *2	A	4.9	5.2
	Refrigeration oil (Model)	L	0.6 (FW68CA)	
Fan motor	Model		SIC-88FWJ-D888-4	
	Current *1, *2	A	0.3	
Dimensions W x H x D		mm	950 x 796 x 330	
Weight		kg	61	
Special remarks	Air flow (Rated)	m ³ /h	2,580	2,430
	Sound level (Rated)	dB(A)	45	47
	Fan speed (Rated)	rpm	480	460
	Pre-charged refrigerant quantity (R32)	kg	2.4	
	Max refrigerant quantity (R32)	kg	2.4	

*1 Measured under rated operating frequency.

*2 When connected with below indoor units below.

MSZ-LN18VG2 + MSZ-LN35VG2

*3 At least 2 indoor units must be connected when using indoor unit with capacity lower than 25 class.

NOTE: Test conditions are based on ISO 5151. (Refrigerant piping length (one way): 5 m)

COOLING INDOOR Dry-bulb temperature 27.0°C Wet-bulb temperature 19.0°C

OUTDOOR Dry-bulb temperature 35.0°C Wet-bulb temperature 24.0°C

HEATING INDOOR Dry-bulb temperature 20.0°C

OUTDOOR Dry-bulb temperature 7.0°C Wet-bulb temperature 6.0°C

Outdoor model			MXZ-4F83VFHZ		
Outdoor unit power supply			Single phase 220 -230 - 240 V, 50 Hz		
System	Indoor units number		1 to 4 *3		
	Piping total length	m	Max. 70		
	Connecting pipe length	m	Max. 25		
	Height difference (Indoor ~ Outdoor)	m	Refer to 8 REFRIGERANT SYSTEM DIAGRAM.		
	Height difference (Indoor ~ Indoor)	m	Refer to 8 REFRIGERANT SYSTEM DIAGRAM.		
Function			Cooling	Heating	
Capacity Rated (Min.-Max.) *2		kW	8.3 (3.5 - 9.2)	9.0 (3.5 - 11.6)	
Breaker capacity		A	30		
Electrical data	Power input (Total) *1, *2		W	1,900	
	Running current (Total) *1, *2		A	8.7 - 8.3 - 8.0	
	Power factor (Total) *1, *2		%	99	
	Starting current (Total) *1, *2		A	8.3	
Coefficient of performance (C.O.P) (Total) *1, *2			4.37	5.29	
Compressor	Model		MVB33BFMFC		
	Output	W	2,200		
	Current *1, *2	A	7.0	6.2	
	Refrigeration oil (Model)	L	1.10 (FW68CA)		
Fan motor	Model		SIC-88FWJ-D888-4		
	Current *1, *2	A	0.3		
Dimensions W x H x D		mm	950 x 1,048 x 330		
Weight		kg	86		
Special remarks	Air flow (Rated)		m ³ /h	3,780	
	Sound level (Rated)		dB(A)	55	
	Fan speed (Rated)		rpm	650	
	Pre-charged refrigerant quantity (R32)			2.4	
	Max refrigerant quantity (R32)		kg	2.4	

*1 Measured under rated operating frequency.

*2 When connected with below indoor units below.

MSZ-LN18VG2 + MSZ-LN18VG2 + MSZ-LN25VG2 + MSZ-LN25VG2

*3 At least 2 indoor units must be connected when using indoor unit with capacity lower than 25 class.

NOTE: Test conditions are based on ISO 5151. (Refrigerant piping length (one way): 5 m)

COOLING INDOOR Dry-bulb temperature 27.0°C Wet-bulb temperature 19.0°C

OUTDOOR Dry-bulb temperature 35.0°C Wet-bulb temperature 24.0°C

HEATING INDOOR Dry-bulb temperature 20.0°C

OUTDOOR Dry-bulb temperature 7.0°C Wet-bulb temperature 6.0°C

NOISE CRITERIA CURVES

MXZ-2F33VF
MXZ-2F33VF2
MXZ-2F33VF3

FAN SPEED	FUNCTION	SPL(dB(A))	LINE
High	Cooling	49	●—●
High	Heating	50	○—○

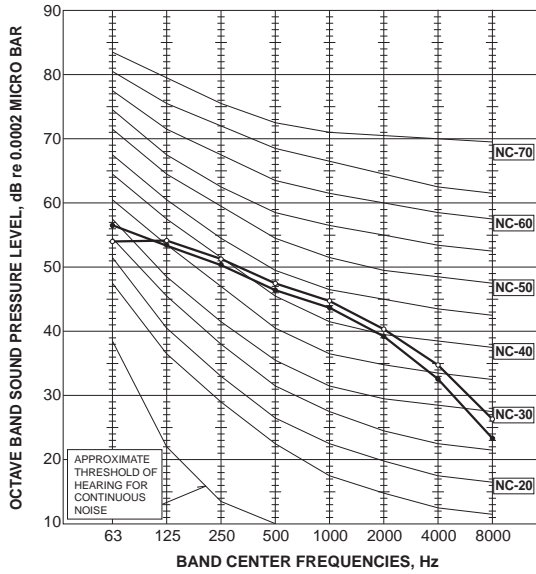

MXZ-2F42VF
MXZ-2F42VF2
MXZ-2F42VF3

FAN SPEED	FUNCTION	SPL(dB(A))	LINE
High	Cooling	44	●—●
High	Heating	50	○—○

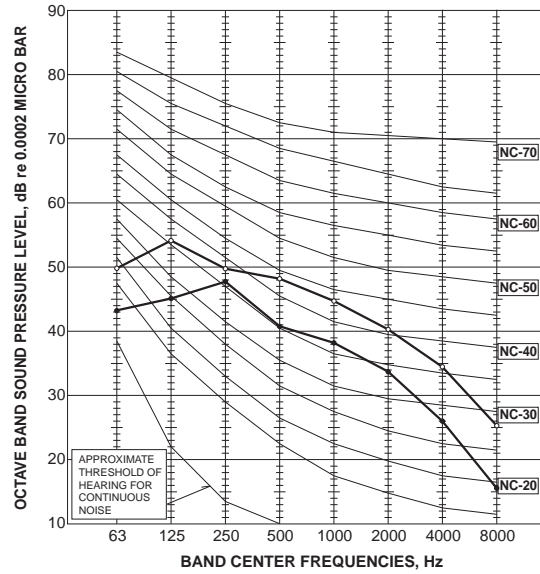

MXZ-2F53VF **MXZ-2F53VFH**
MXZ-2F53VF2 **MXZ-2F53VFH2**
MXZ-2F53VF3 **MXZ-2F53VFH3**

FAN SPEED	FUNCTION	SPL(dB(A))	LINE
High	Cooling	46	●—●
High	Heating	51	○—○

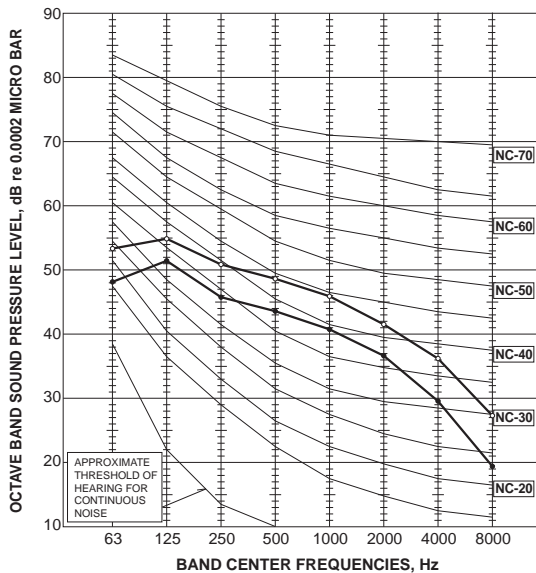

MXZ-3F54VF
MXZ-3F54VF2
MXZ-3F54VF3

FAN SPEED	FUNCTION	SPL(dB(A))	LINE
High	Cooling	46	●—●
High	Heating	50	○—○

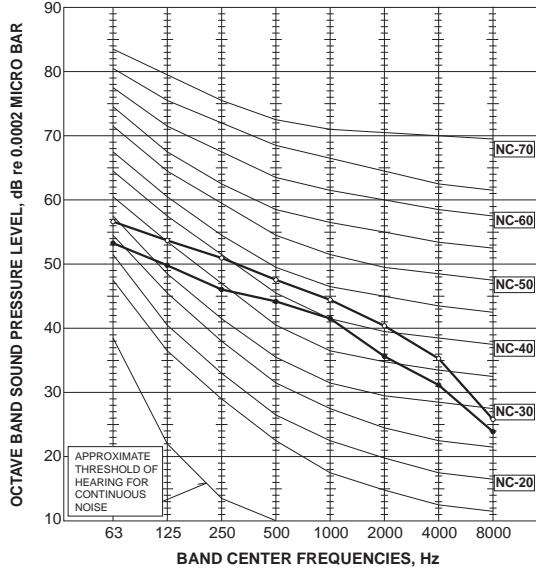

MXZ-3F68VF
MXZ-3F68VF2
MXZ-3F68VF3

FAN SPEED	FUNCTION	SPL(dB(A))	LINE
High	Cooling	48	●—●
High	Heating	53	○—○

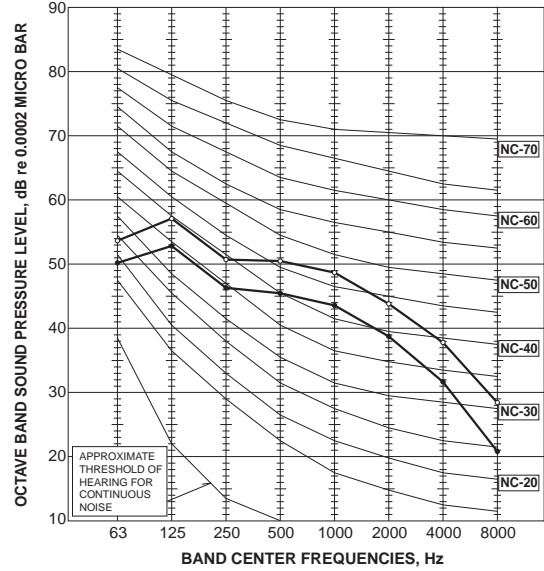

MXZ-4F72VF
MXZ-4F72VF2
MXZ-4F72VF3

FAN SPEED	FUNCTION	SPL(dB(A))	LINE
High	Cooling	48	●—●
High	Heating	54	○—○

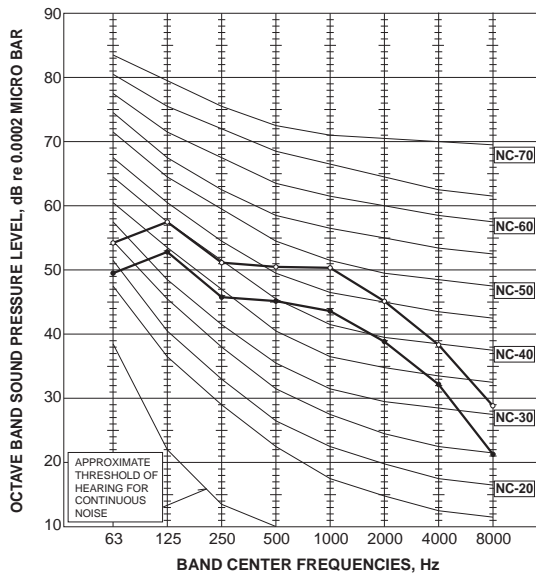

MXZ-4F80VF2
MXZ-4F80VF3

FAN SPEED	FUNCTION	SPL(dB(A))	LINE
High	Cooling	50	●—●
High	Heating	55	○—○

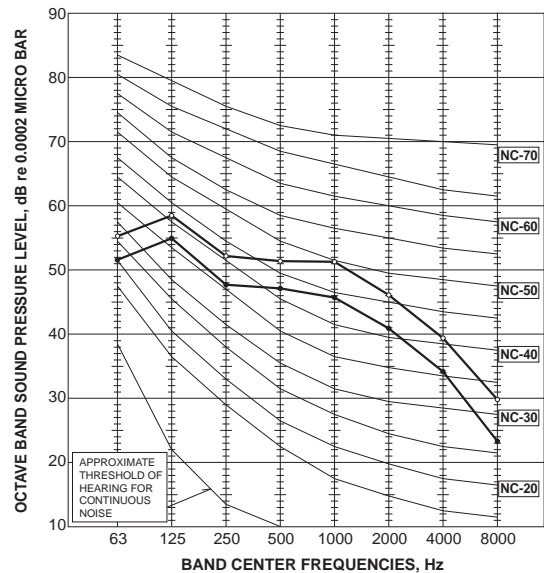

MXZ-4F83VF

FAN SPEED	FUNCTION	SPL(dB(A))	LINE
High	Cooling	49	●—●
High	Heating	51	○—○

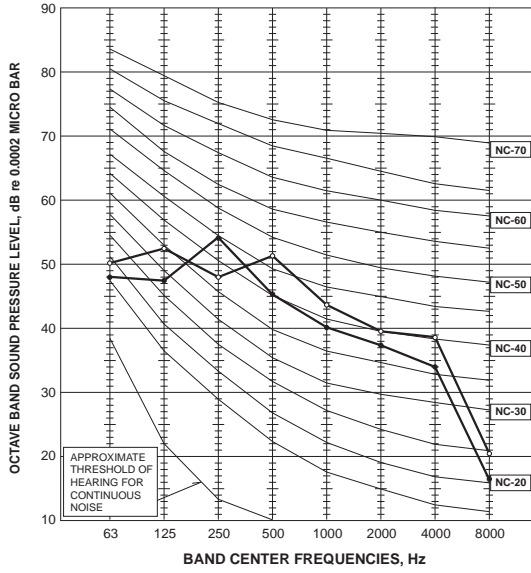

MXZ-5F102VF

FAN SPEED	FUNCTION	SPL(dB(A))	LINE
High	Cooling	52	●—●
High	Heating	56	○—○

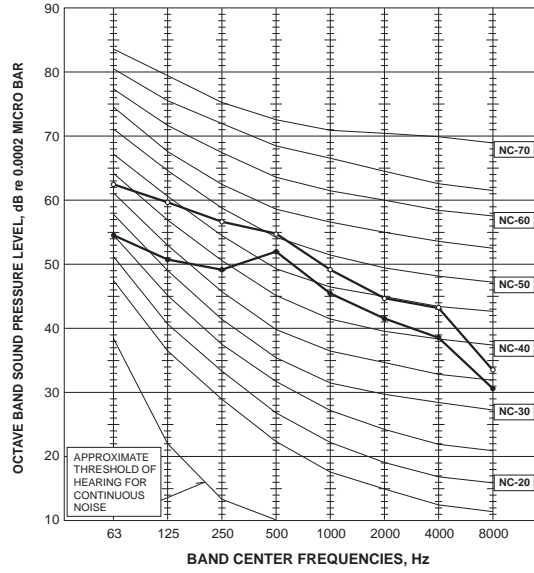

MXZ-6F122VF

FAN SPEED	FUNCTION	SPL(dB(A))	LINE
High	Cooling	55	●—●
High	Heating	57	○—○

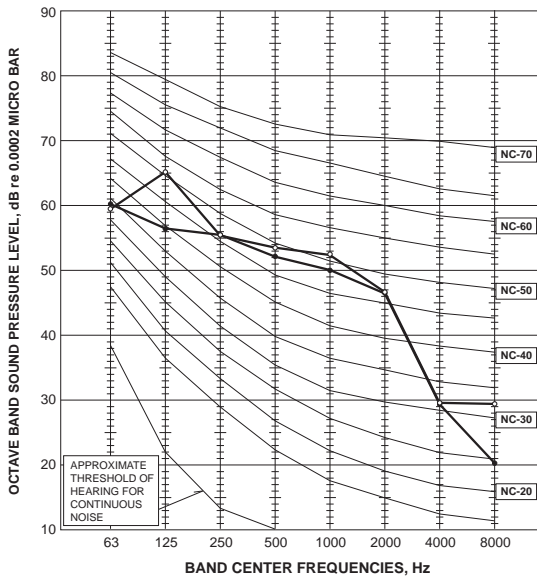

MXZ-2F53VFHZ

FAN SPEED	FUNCTION	SPL(dB(A))	LINE
High	Cooling	45	●—●
High	Heating	47	○—○

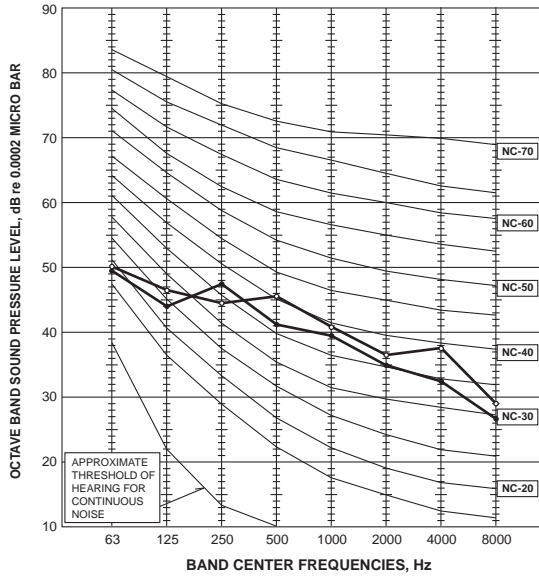

MXZ-4F83VFHZ

FAN SPEED	FUNCTION	SPL(dB(A))	LINE
High	Cooling	55	●—●
High	Heating	57	○—○

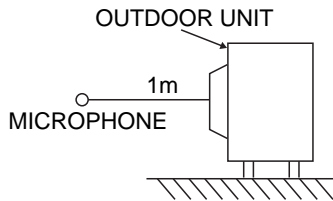
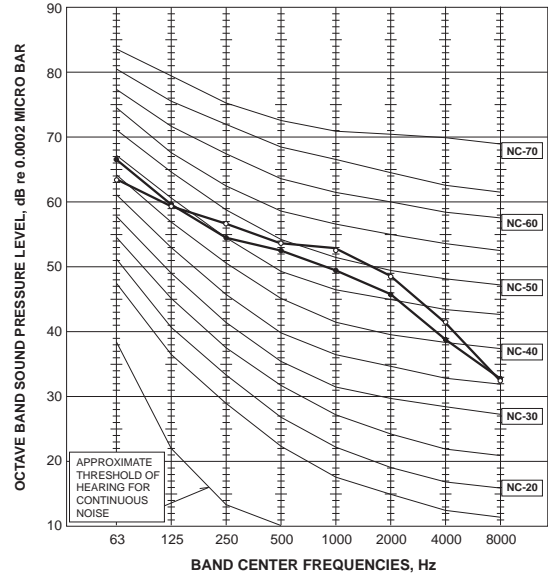

Test conditions

Cooling :Dry-bulb temperature 35.0°C Wet-bulb temperature 24.0°C
 Heating :Dry-bulb temperature 7.0°C Wet-bulb temperature 6.0°C

MXZ-2F33VF MXZ-2F42VF MXZ-2F53VF MXZ-2F53VFH
 MXZ-2F33VF2 MXZ-2F42VF2 MXZ-2F53VF2 MXZ-2F53VFH2
 MXZ-2F33VF3 MXZ-2F42VF3 MXZ-2F53VF3 MXZ-2F53VFH3

Unit: mm

1. Installation space

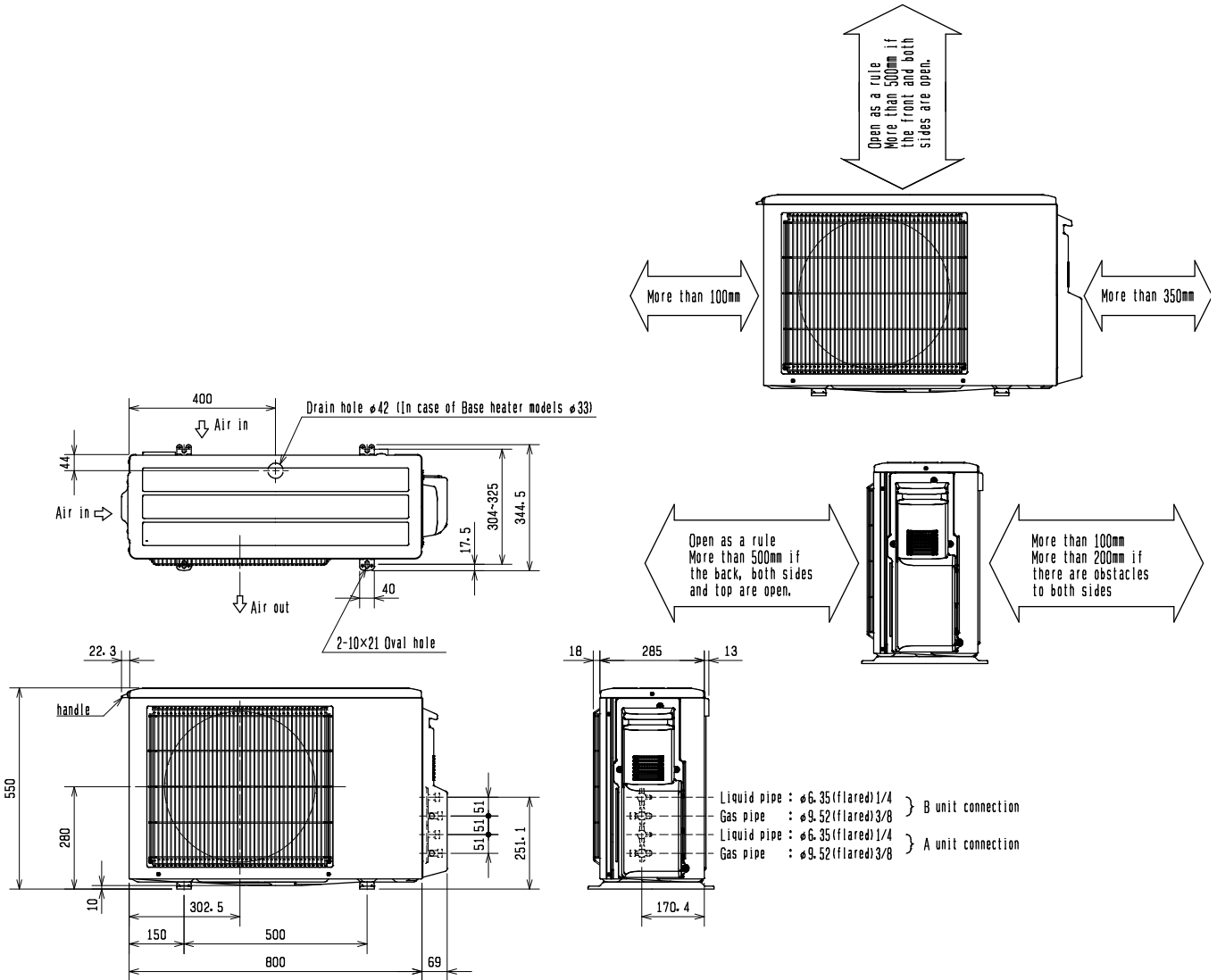

MXZ-3F54VF MXZ-3F68VF
MXZ-3F54VF2 MXZ-3F68VF2
MXZ-3F54VF3 MXZ-3F68VF3

Unit: mm

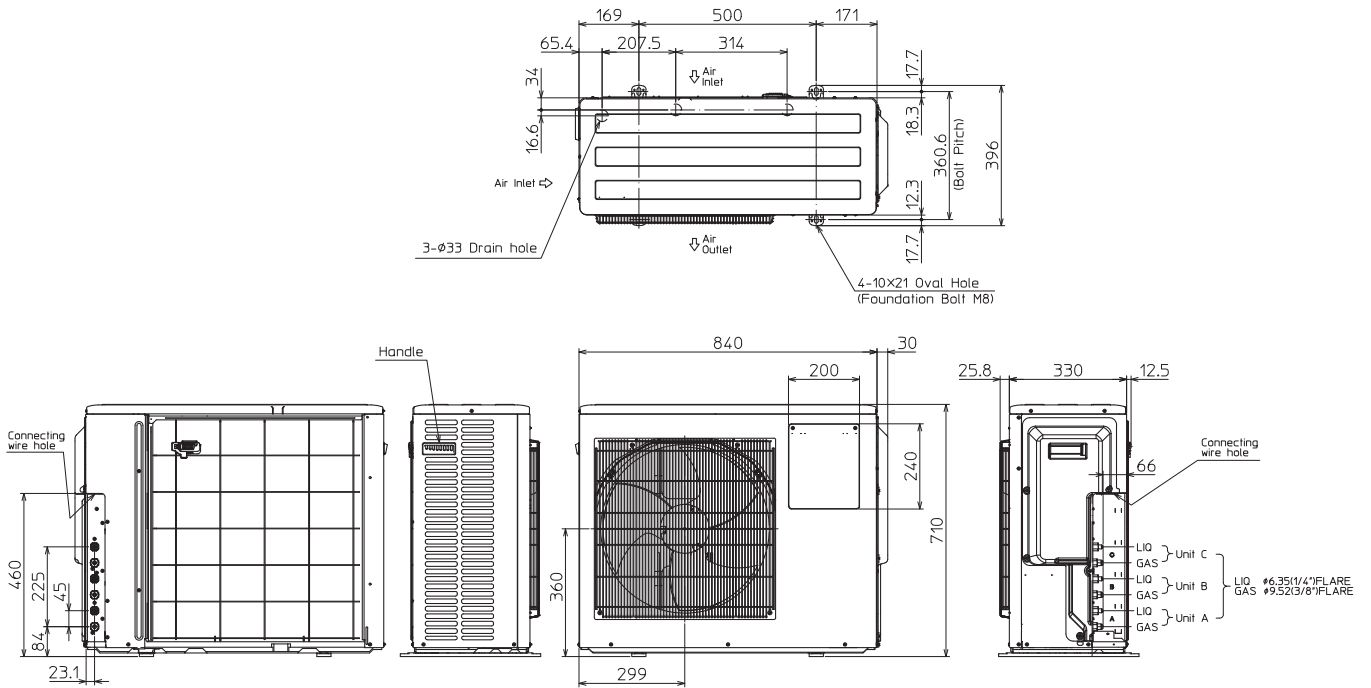

1. Installation space

Note : Leave front and both sides free of obstruction.

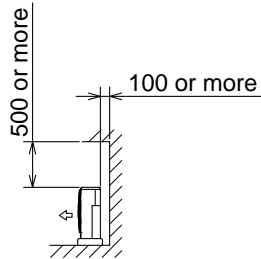

2. Service space

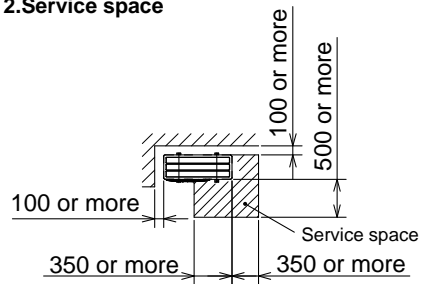

Note : Leave front and overhead free of obstruction.

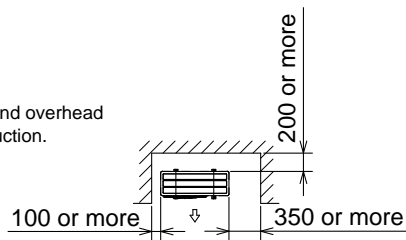

Note : Leave rear, overhead and both sides free of obstruction.

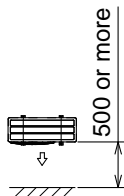

MXZ-4F72VF
MXZ-4F72VF2 MXZ-4F80VF2
MXZ-4F72VF3 MXZ-4F80VF3

Unit: mm

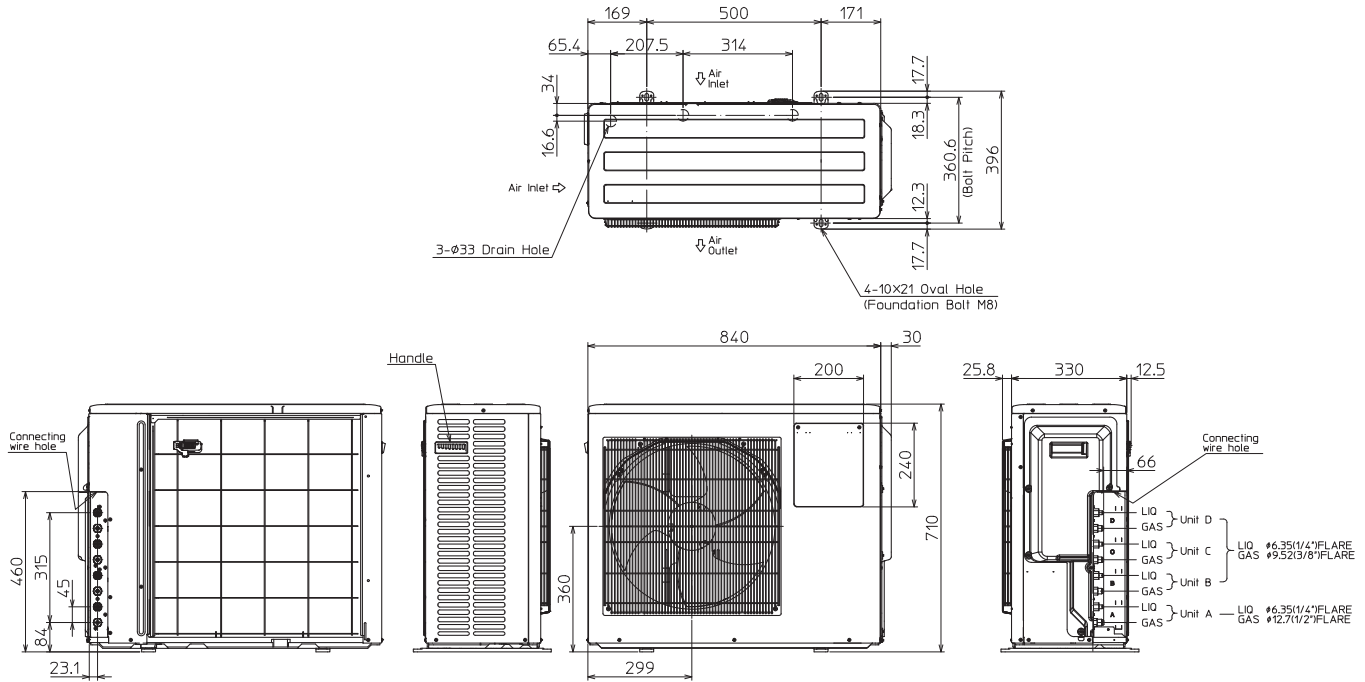

1. Installation space

Note : Leave front and both sides free of obstruction.

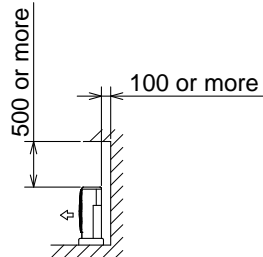

2. Service space

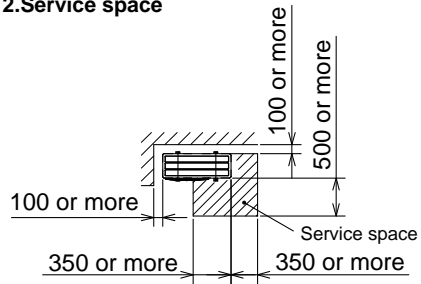

Note : Leave front and overhead free of obstruction.



Note : Leave rear, overhead and both sides free of obstruction.

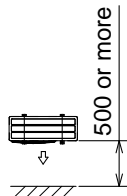

MXZ-4F83VF

Unit: mm

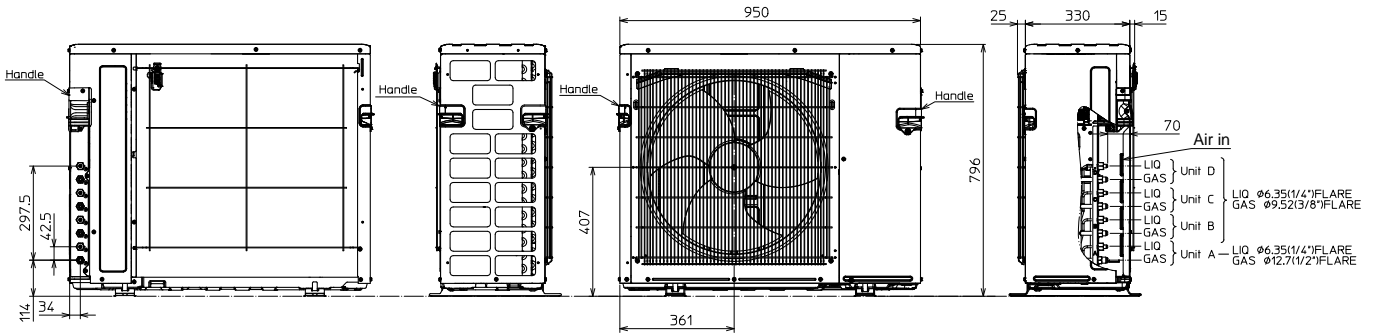
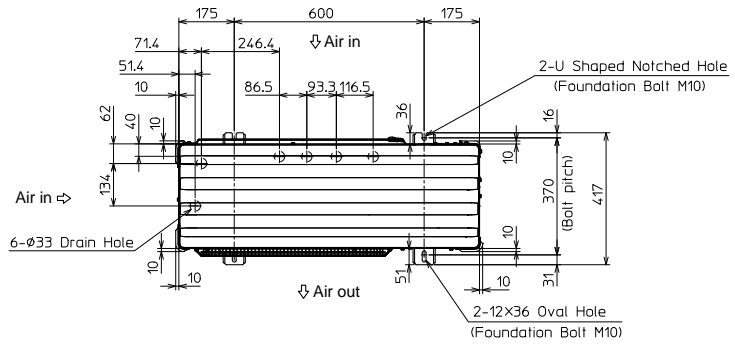

1.FREE SPACE

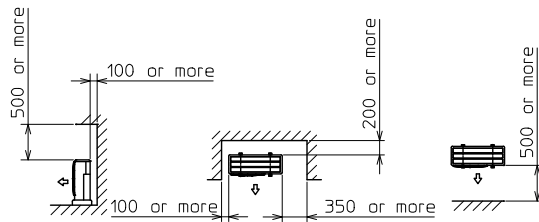

2.SERVICE SPACE

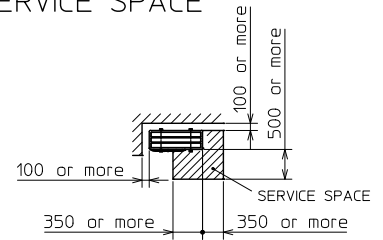

MXZ-5F102VF

Unit: mm

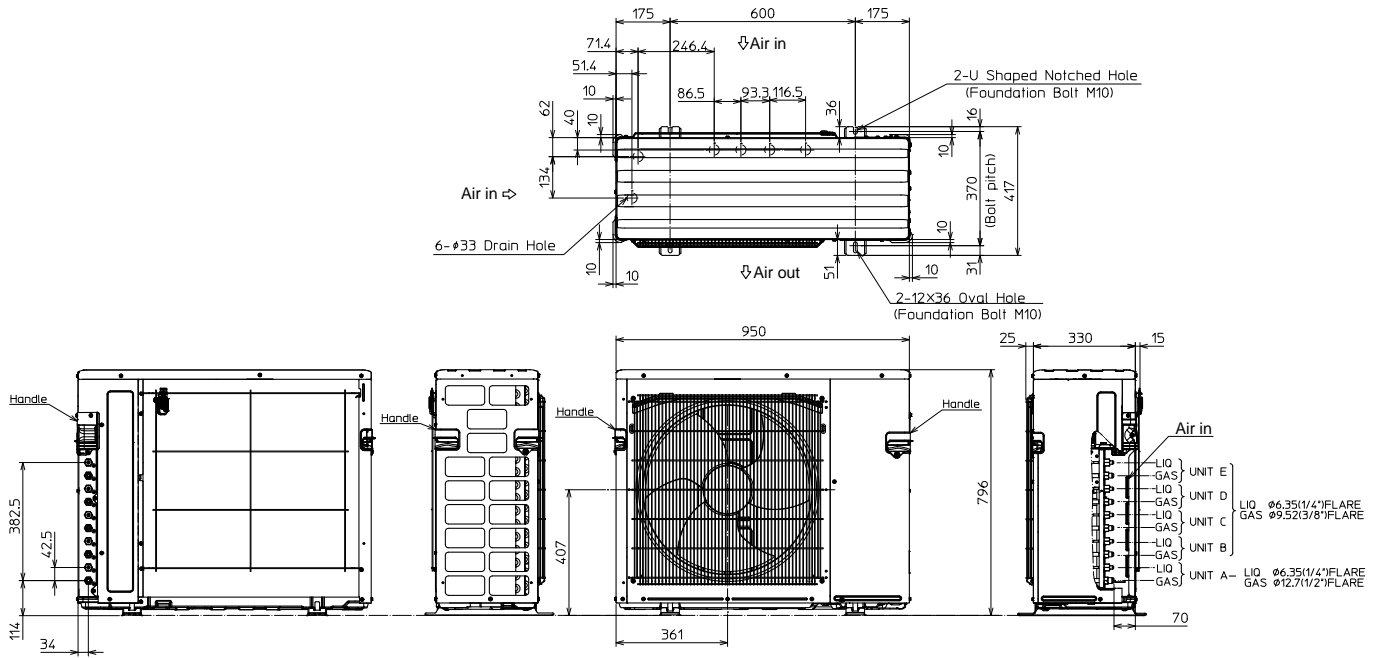

1.FREE SPACE

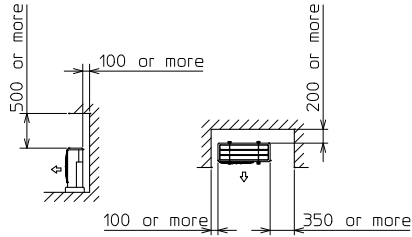

2.SERVICE SPACE

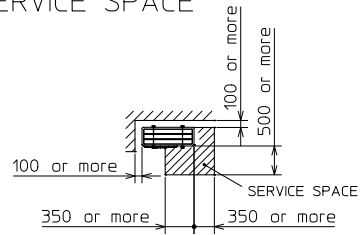

MXZ-2F53VFHZ

Unit: mm

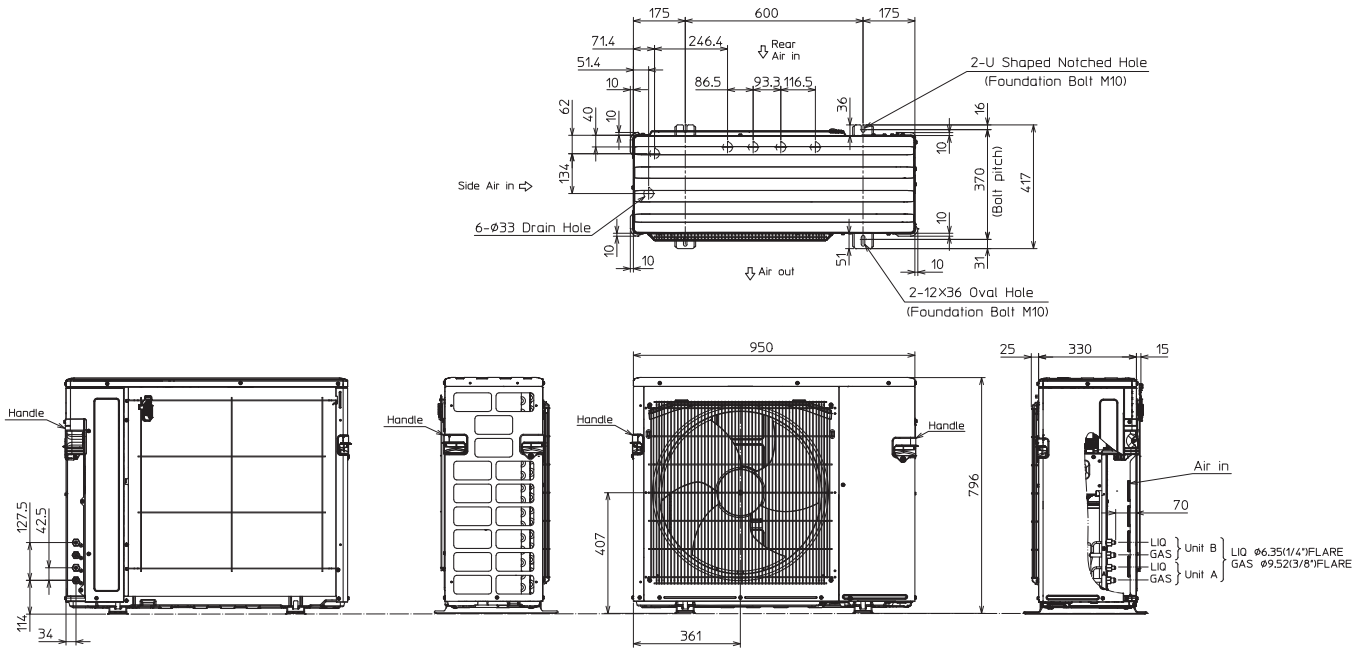

1.FREE SPACE

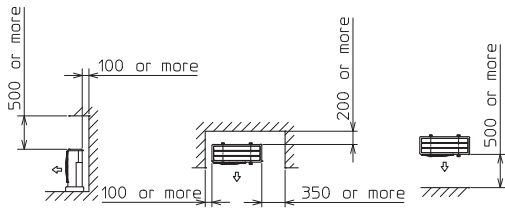

2.SERVICE SPACE

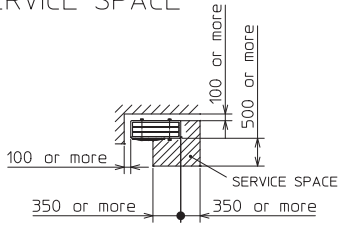

MXZ-4F83VFHZ

Unit: mm

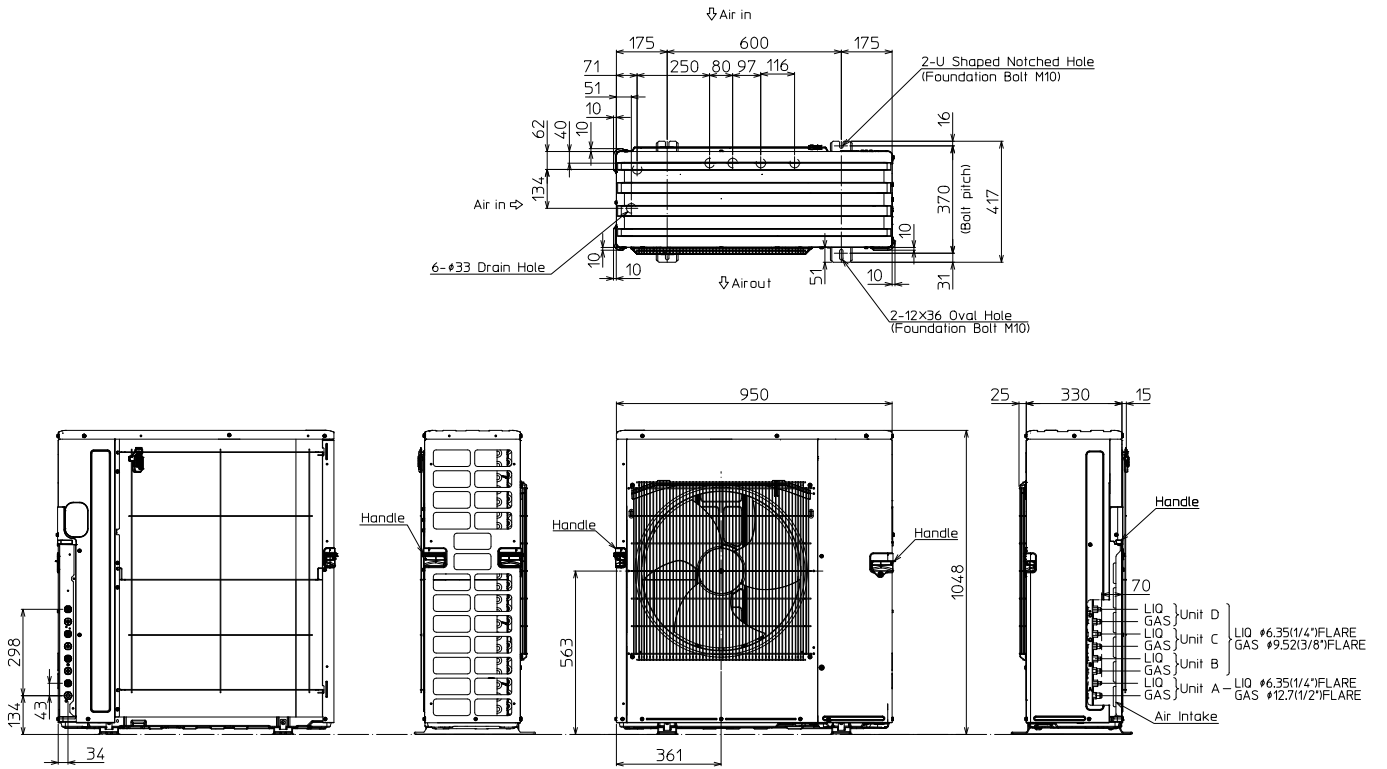

1.FREE SPACE

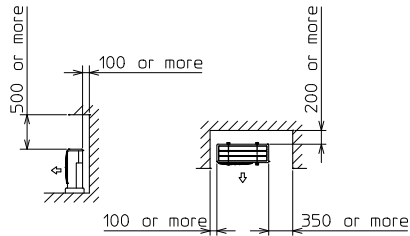

2.SERVICE SPACE

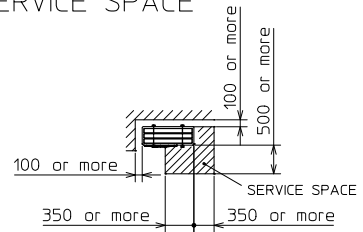

MXZ-2F33VF - [E1], [ET1] MXZ-2F42VF - [E1], [ET1] MXZ-2F53VF - [E1], [ET1]

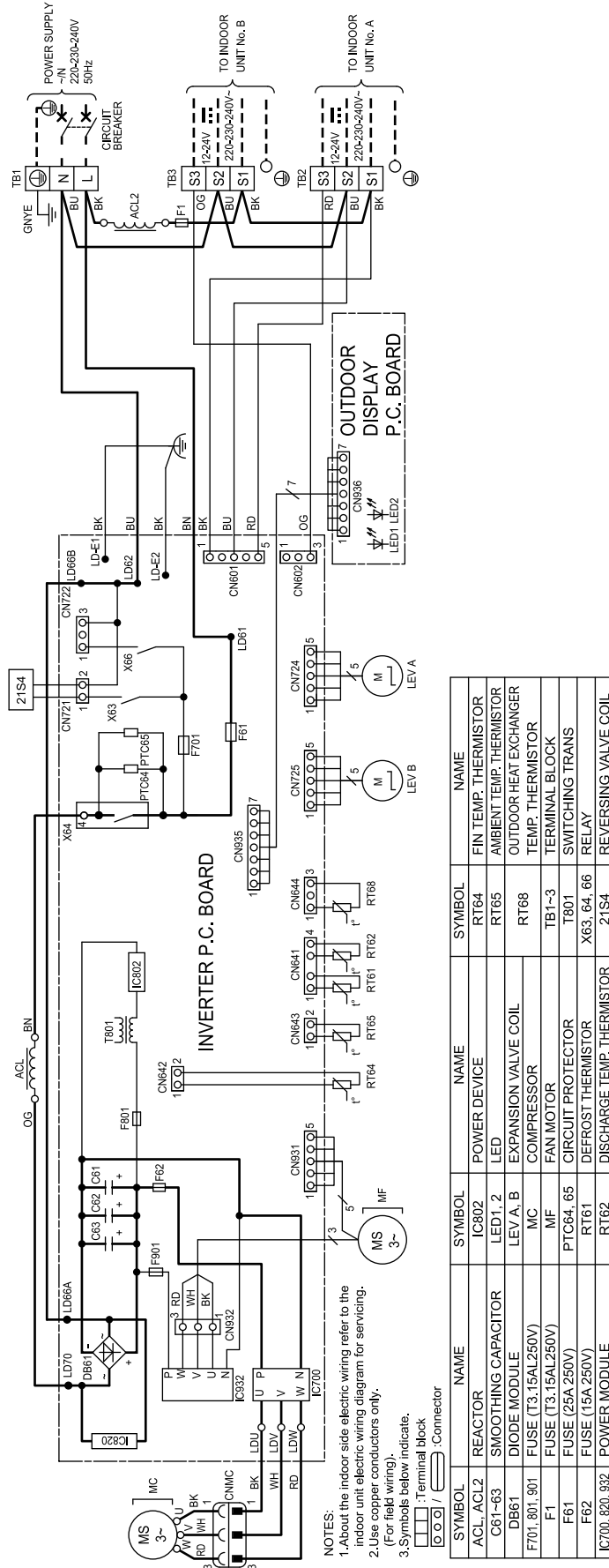

SYMBOL	NAME	SYMBOL	NAME	SYMBOL	NAME
IC802	REACTOR	RT64	FIN TEMP. THERMISTOR	21S4	REVERSING VALVE COIL
C61-63	SMOOTHING CAPACITOR	RT65	AMBIENT TEMP. THERMISTOR		
DB61	DIODE MODULE	RT68	OUTDOOR HEAT EXCHANGER TEMP. THERMISTOR		
F701, 801, 901	FUSE (T3:15AL250V)	TB1-3	TERMINAL BLOCK		
F1	FUSE (25A, 250V)	T801	SWITCHING TRANS RELAY		
F62	FUSE (15A, 250V)	X63, 64, 66	RELAY		
IC700, 820, 932	POWER MODULE	21S4	REVERSING VALVE COIL		

MXZ-2F33VF2 - [E1] MXZ-2F42VF2 - [E1] MXZ-2F53VF2 - [E1]

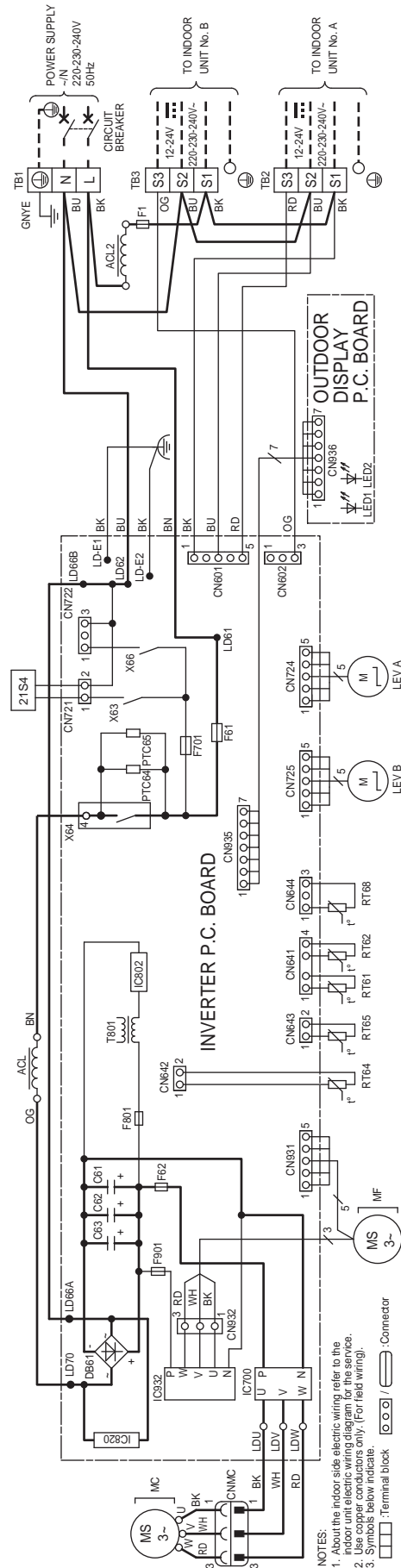

NOTES:
 1. About the indoor side electric wiring refer to the indoor unit electric wiring diagram for the service.
 2. Use copper conductors only. (For field wiring).
 3. Symbols below indicate.
 □ □ □ □ : Terminal block
 ○ ○ ○ ○ / ○ ○ ○ ○ : Connector

SYMBOL	NAME	SYMBOL	NAME	SYMBOL	NAME
ACL, ACL2	REACTOR	IC802	POWER DEVICE	RT64	FIN TEMP. THERMISTOR
C61-63	SMOOTHING CAPACITOR	LED1, 2	LED	RT65	AMBIENT TEMP. THERMISTOR
DB61	DIODE MODULE	LEV A, B	EXPANSION VALVE COIL	RT68	OUTDOOR HEAT EXCHANGER
F701, 801, 801	FUSE (T3, 15AL/250V)	MC	COMPRESSOR	TB1-3	TEMP. THERMISTOR
F81	FUSE (T3, 15AL/250V)	MF	FAN MOTOR	TERMINAL BLOCK	
F82	FUSE (25A/250V)	PTC64, 65	CIRCUIT PROTECTOR	T801	TRANSFORMER
IC700, 820, 932	POWER MODULE	RT61	DEFROST THERMISTOR	X63, 64, 66	RELAY
		RT62	DISCHARGE TEMP. THERMISTOR	2T54	REVERSING VALVE COIL

MXZ-2F33VF2 - [ET1] MXZ-2F42VF2 - [ET1] MXZ-2F53VF2 - [ET1]

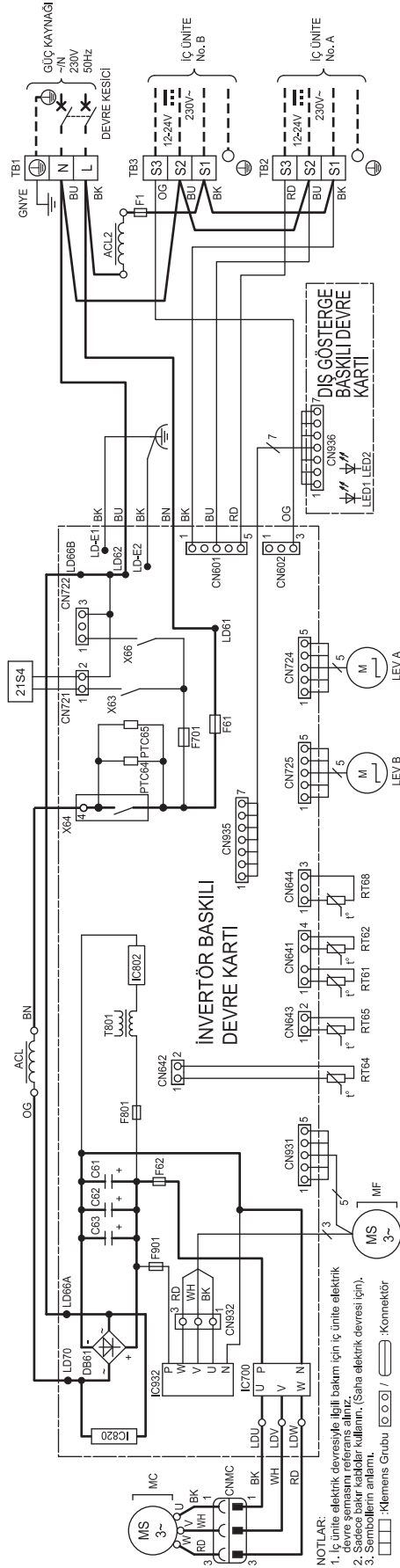

NOTLAR:
 1. İç ünite elektrik devresiyile ilgili bakımlar için iç ünite elektrik devre şemasını referans alınınız.
 2. İç ünite elektrik devresiyile ilgili bakımlar için dış ünite elektrik devresiyi referans alınınız.
 3. Sembollerin anlamı:
 □ : Klemens Grubu □ □ □ □ / □ : Konnektör

SEMBOLE	PARÇA ADI	SEMBOLE	PARÇA ADI
ACL, ACL2	REAKTÖR	IC802	GÜÇ CİHAZI
C61-63	KAPASİTÖR	LED1, 2	LED
DB61	DIYOT MODÜLÜ	LEV A, B	GENLEŞME VANASI SARGISI
F701, 801, 901	SİGORTA (T3,15AL,250V)	MC	KOMPRESÖR
F1	SİGORTA (T3,15AL,250V)	MF	FAN MOTORU
F61	SİGORTA (25A,250V)	PTC64, 65	DEVRE KORUMASI
F62	SİGORTA (15A,250V)	RT61	DEFROST TERMİSTÖRÜ
IC700, 820, 932	GÜÇ MODÜLÜ	RT62	BASMA SICAKLIK TERMİSTÖRÜ
		RT64	FIN SICAKLIK TERMİSTÖRÜ
		RT65	ORTAM SICAKLIK TERMİSTÖRÜ
		RT68	DİŞ UNİTE ESANJÖR SICAKLIK TERMİSTÖRÜ
		TB1-3	KLEMENS GRUBU
		T801	TRANSFORMATÖR
		X63, 64, 66	RÖLE
		21S4	İKİ YÖNLÜ VANA SARGISI

MXZ-2F33VF3 -[E1], -[E2] MXZ-2F42VF3 -[E1], -[E2] MXZ-2F53VF3 -[E1], -[E2]

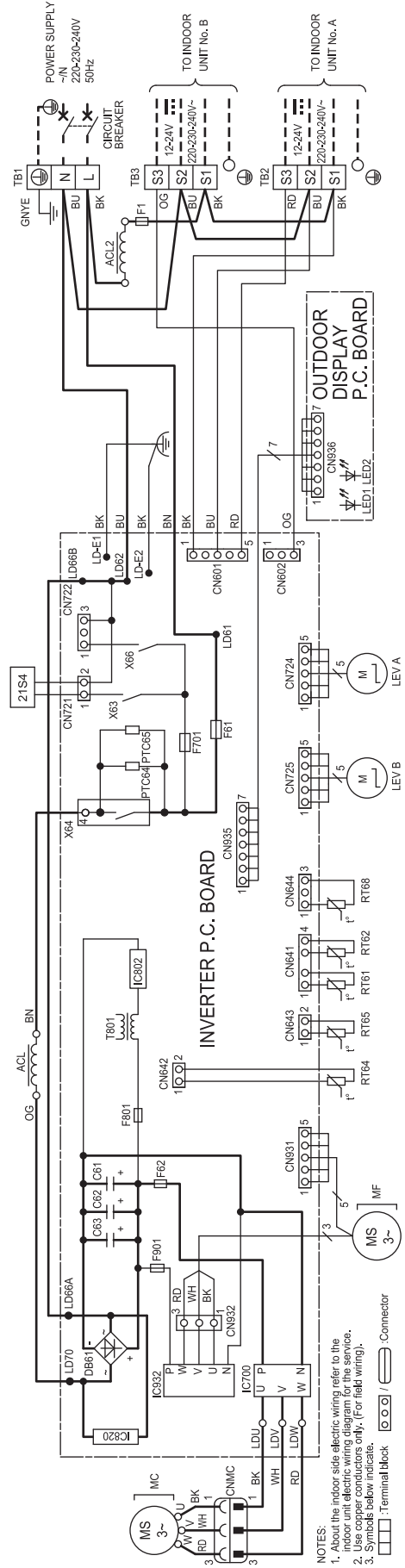

- NOTES:
1. About the indoor side electric wiring refer to the indoor unit electric wiring diagram for the service.
 2. Use copper conductors only. (For field wiring).
 3. Symbols refer to the legend.

SYMBOL	NAME	SYMBOL	NAME	SYMBOL	NAME
IC802	REACTOR	IC802	POWER DEVICE	RT64	FIN TEMP. THERMISTOR
ACL, ACL2	SMOOTHING CAPACITOR	LED1, 2	LED	RT65	AMBIENT TEMP. THERMISTOR
C61~63	DIODE MODULE	LEV A, B	EXPANSION VALVE COIL	RT68	OUTDOOR HEAT EXCHANGER TEMP. THERMISTOR
DB61	FUSE (T3, 15A/250V)	MC	COMPRESSOR	TB1~3	TERMINAL BLOCK
F701, 801, 901	FUSE (T3, 15A/250V)	MF	FAN MOTOR	T801	TRANSFORMER
F61	FUSE (25A 250V)	PTC64, 65	CIRCUIT PROTECTOR	X63, 64, 66	RELAY
F62	FUSE (15A 250V)	RT61	DEFROST THERMISTOR	21S4	REVERSING VALVE COIL
IC700, 820, 932	POWER MODULE	RT62	DISCHARGE TEMP. THERMISTOR		

MXZ-2F33VF3 - [ET1] MXZ-2F42VF3 - [ET1] MXZ-2F53VF3 - [ET1]

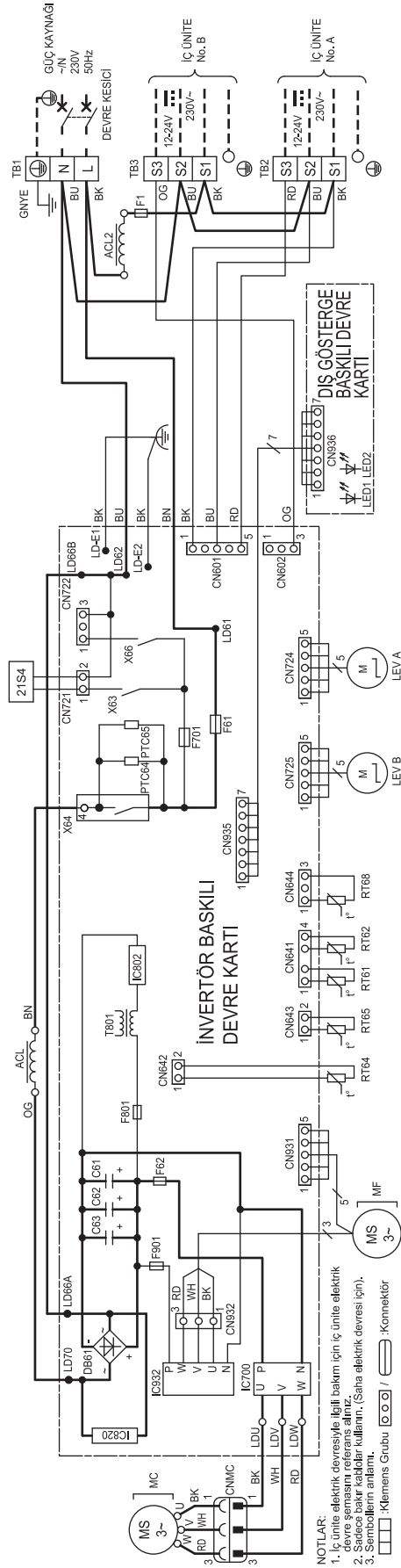

NOTLAR:
 1. İç ünite elektrik devresiyle ilgili bakımlar için iç ünite elektrik devre şemasını referans alınınız.
 2. Sadece bakır kablolar kullanınız. (Saha elektrik devresi için).
 3. Sembollerin anlamı için bkz. 4.
 4. Klemens Grubu: / :Konnektör

SEMBOLE	PARÇA ADI	SEMBOLE	PARÇA ADI																																		
ACL, ACL2	REAKTÖR	IC802	GÜÇ CİHAZI																																		
C61-63	KAPASİTÖR	LED1, 2	LED																																		
DB61	DIYOT MODÜLÜ	LEV A, B	GENLEŞME VANASI SARGISI																																		
F701, 801, 901	SİGORTA (T3,15AL,250V)	MC	KOMPRESÖR																																		
F1	SİGORTA (T3,15AL,250V)	MF	FAN MOTORU																																		
F61	SİGORTA (25A,250V)	PTC64, 65	DEVRE KORUMASI																																		
F62	SİGORTA (15A,250V)	RT161	DEFROST TERMİSTÖRÜ																																		
IC700, 820, 932	GÜÇ MODÜLÜ	RT162	BASMA SICAKLIK TERMİSTÖRÜ																																		
		RT64	RT65	RT66	RT68	RT69	RT70	RT71	RT72	RT73	RT74	RT75	RT76	RT77	RT78	RT79	RT80	RT81	RT82	RT83	RT84	RT85	RT86	RT87	RT88	RT89	RT90	RT91	RT92	RT93	RT94	RT95	RT96	RT97	RT98	RT99	RT100

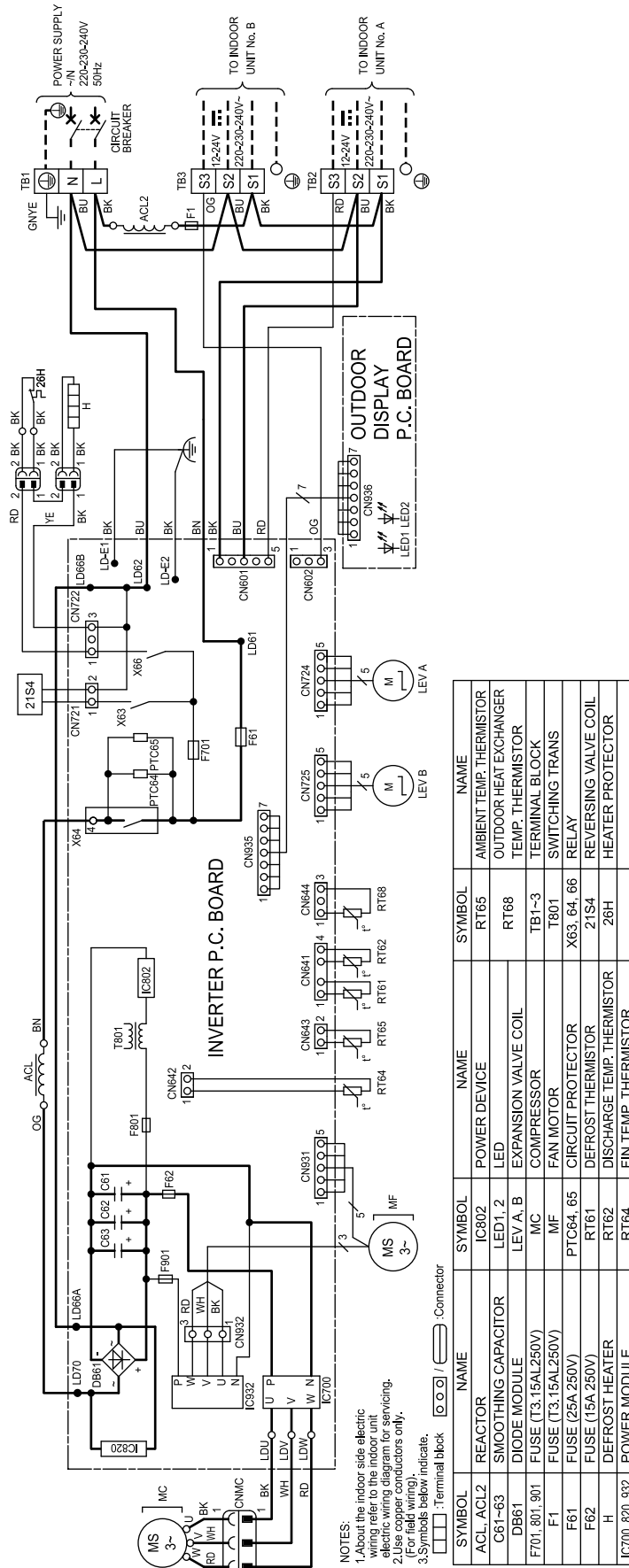

- NOTES:
- 1>About the indoor side electric wiring refer to the indoor unit electric wiring diagram for servicing. (For field wiring).
 - 2:Use copper conductors only.
 - 3:Symbols below indicate.
 - □ □ □ □ : Terminal block
 - ○ ○ ○ ○ / ○ ○ ○ ○ ○ : Connector

SYMBOL	NAME	SYMBOL	NAME	SYMBOL	NAME
ACL, ACL2	REACTOR	IC802	POWER DEVICE	RT65	AMBIENT TEMP. THERMISTOR
C61-63	SMOOTHING CAPACITOR	LED1, 2	LED	RT68	OUTDOOR HEAT EXCHANGER TEMP. THERMISTOR
DB61	DIODE MODULE	LEV A, B	EXPANSION VALVE COIL	TB1-3	TERMINAL BLOCK
F701, 801, 901	FUSE (T3,15AL250V)	MC	COMPRESSOR	T801	SWITCHING TRANS
F1	FUSE (T3,15AL250V)	MF	FAN MOTOR	X63, 64, 66	RELAY
F61	FUSE (25A 250V)	PTC64, 65	CIRCUIT PROTECTOR	21S4	REVERSING VALVE COIL HEATER PROTECTOR
F62	FUSE (15A 250V)	RT61	DEFROST THERMISTOR	26H	HEATER PROTECTOR
H	DEFROST HEATER	RT62	DISCHARGE TEMP. THERMISTOR		
IC700, 820, 932	POWER MODULE	RT64	FIN TEMP. THERMISTOR		

MXZ-2F53VFH2 -E1

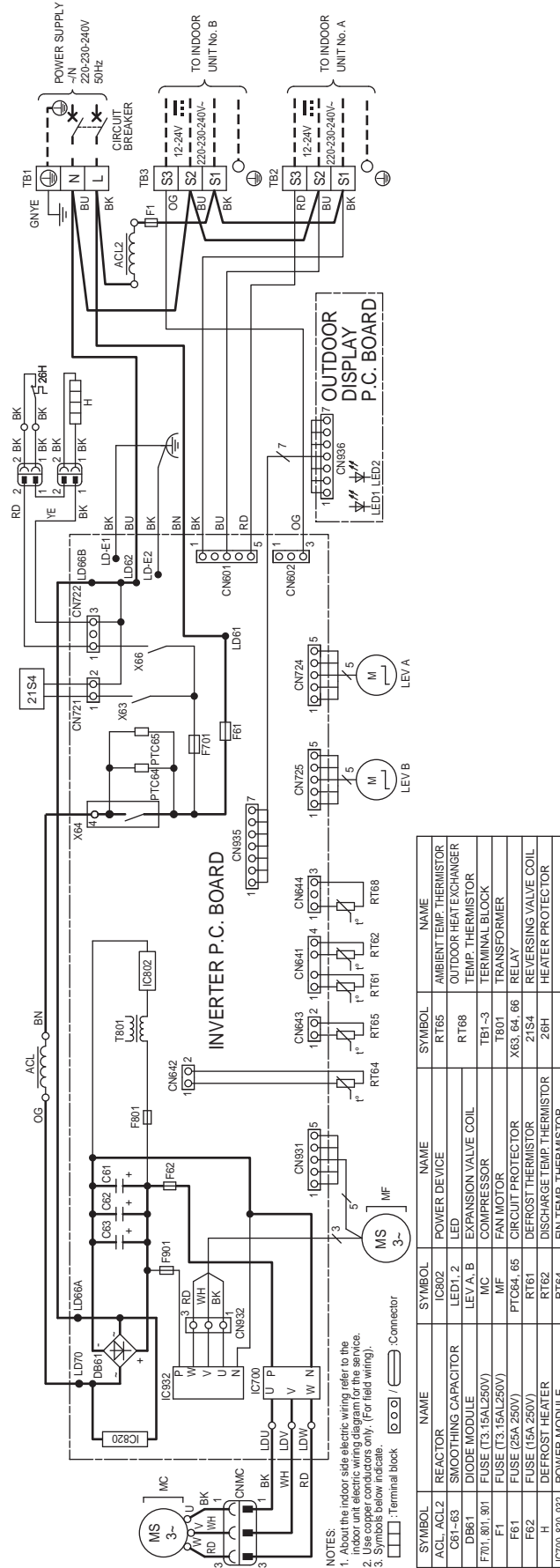

NOTES:
 1. About the indoor side electric wiring refer to the indoor unit electric wiring diagram for the service.
 2. Use copper conductors only. (For field wiring).
 3. Symbols below indicate:
 □ □ □ □ □ : Terminal block
 □ □ □ □ □ / □ □ □ □ □ : Connector

SYMBOL	NAME	SYMBOL	NAME	SYMBOL	NAME
IC802	REACTOR	IC802	POWER DEVICE	RT65	AMBIENT TEMP. THERMISTOR
C81-63	SMOOTHING CAPACITOR	LED1, 2	LED	RT68	OUTDOOR HEAT EXCHANGER TEMP. THERMISTOR
DB61	DIODE MODULE	LEV. A, B	EXPANSION VALVE COIL	TB1-3	TERMINAL BLOCK
F701, 801, 901	FUSE (T3.15AL250V)	MC	COMPRESSOR	T801	TRANSFORMER
F1	FUSE (T3.15AL250V)	MF	FAN MOTOR	X63, 64, 66	RELAY
F61	FUSE (25A, 250V)	PTC64, 65	CIRCUIT PROTECTOR	21S4	REVERSING VALVE COIL
F62	FUSE (16A, 250V)	RT61	DEFROST THERMISTOR	26H	HEATER PROTECTOR
H	DEFROST HEATER	RT62	DISCHARGE TEMP. THERMISTOR		
IC700, 820, 932	POWER MODULE	RT64	FIN TEMP. THERMISTOR		

MXZ-2F53VFH3 -E1, -E2

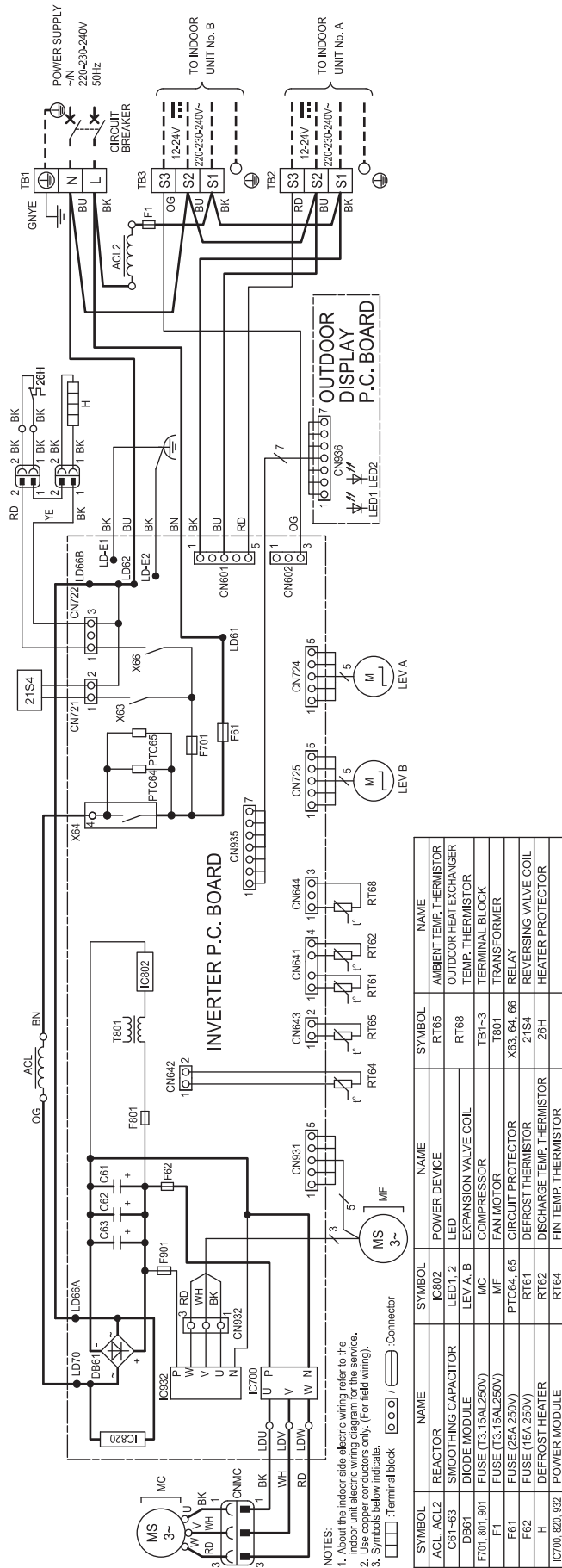

NOTES:
 1. About the indoor side electric wiring refer to the indoor unit electric wiring diagram for the services.
 2. Use capped conductors only. (For field wiring).
 3. Symbols refer to the parts.

□ □ □ □ □ : Terminal block □ □ □ □ □ : Connector

SYMBOL	NAME	SYMBOL	NAME	SYMBOL	NAME
ACL, ACL2	REACTOR	IC802	POWER DEVICE	RT65	AMBIENT TEMP. THERMISTOR
C81-63	SMOOTHING CAPACITOR	LED1, 2	LED	RT68	OUTDOOR HEAT EXCHANGER TEMP. THERMISTOR
DB81	DIODE MODULE	LEV A, B	EXPANSION VALVE COIL	TB1-3	TERMINAL BLOCK
F701, 801, 901	FUSE (T3,15A/250V)	MC	COMPRESSOR	T801	TRANSFORMER
F1	FUSE (T3,15A/250V)	MF	FAN MOTOR	X63, 64, 66	RELAY
F61	FUSE (25A,250V)	PTC64, 65	CIRCUIT PROTECTOR	21S4	DISCHARGE TEMP. THERMISTOR
F62	FUSE (16A,250V)	RT61	DEFROST THERMISTOR	28H	HEATER PROTECTOR
H	DEFROST HEATER	RT62	FIN TEMP. THERMISTOR		
IC700, 320, 392	POWER MODULE	RT64	FIN TEMP. THERMISTOR		

MXZ-3F54VF - E1, ET1, E2, ET2
MXZ-3F68VF - E1, ET1, E2, ET2

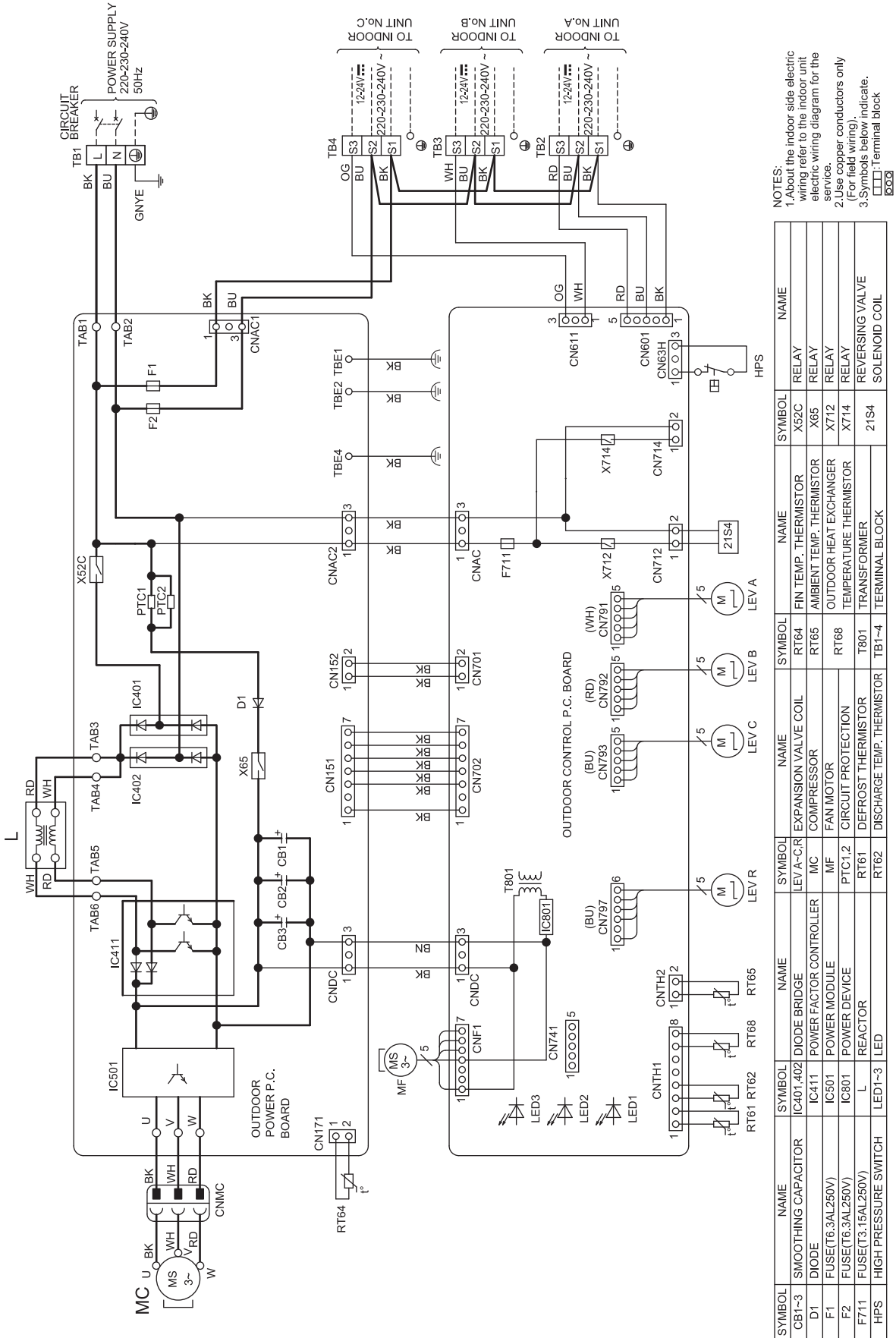

NOTES:
 1. About the indoor side electric wiring refer to the indoor unit electric wiring diagram for the service.
 2. Use copper conductors only (For field wiring).
 3. Symbols below indicate.
 □□□: terminal block
 □□□□: terminal block

SYMBOL	NAME	SYMBOL	NAME	SYMBOL	NAME	SYMBOL	NAME
CB1-3	SMOOTHING CAPACITOR	IC401,402	DIODE BRIDGE	LEV A-C/R	EXPANSION VALVE COIL	X52C	RELAY
D1	DIODE	IC411	POWER FACTOR CONTROLLER	MC	COMPRESSOR	X65	RELAY
F1	FUSE(T6.3AL250V)	IC501	POWER MODULE	MF	FAN MOTOR	X712	RELAY
F2	FUSE(T6.3AL250V)	IC801	POWER DEVICE	PTC1,2	CIRCUIT PROTECTION	X714	RELAY
F711	FUSE(T3.15AL250V)	L	REACTOR	RT61	DEFROST THERMISTOR	21S4	SOLENOID COIL
HPS	HIGH PRESSURE SWITCH	LED1-3	LED	RT62	DISCHARGE TEMP. THERMISTOR		
				RT65	DIODE BRIDGE		
				RT66	FIN TEMP. THERMISTOR		
				RT68	AMBIENT TEMP. THERMISTOR		
				T801	TEMPERATURE THERMISTOR		
				TB1-4	TERMINAL BLOCK		

MXZ-3F54VF2 - E1

MXZ-3F68VF2 - E1

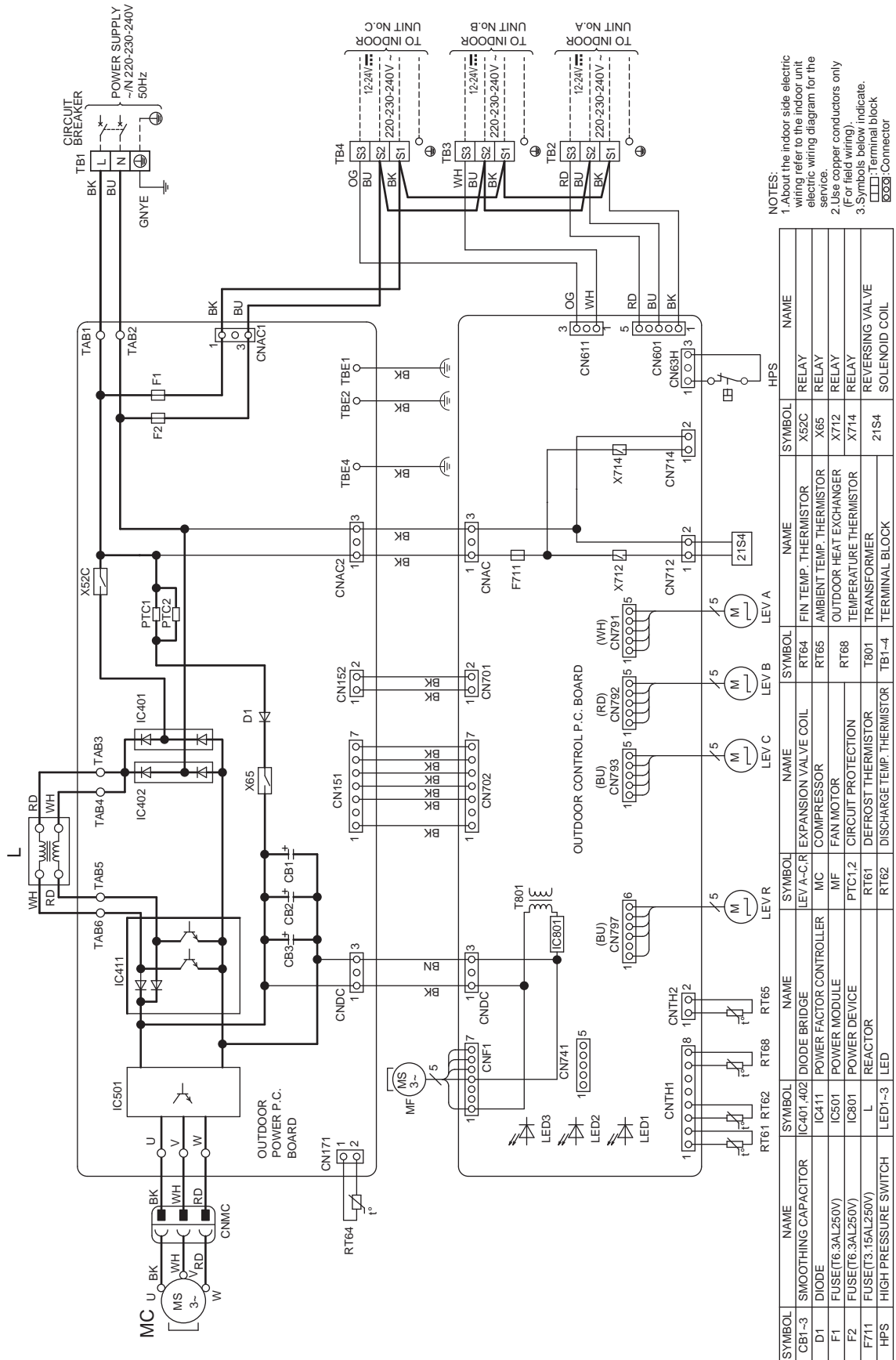

- NOTES:
1. About the indoor side electric wiring refer to the indoor unit electric wiring diagram for the service.
 2. Use copper conductors only (For field wiring).
 3. Symbols below indicate.
 - Terminal block
 - Connector

SYMBOL	NAME	SYMBOL	NAME	SYMBOL	NAME	SYMBOL	NAME
CB1-3	SMOOTHING CAPACITOR	IC401,402	DIODE BRIDGE	LEV A-C,R	EXPANSION VALVE COIL	RT64	FIN TEMP. THERMISTOR
D1	DIODE	IC411	POWER FACTOR CONTROLLER	MC	COMPRESSOR	RT65	AMBIENT TEMP. THERMISTOR
F1	FUSE(T6.3AL250V)	IC501	POWER MODULE	MF	FAN MOTOR	RT68	OUTDOOR HEAT EXCHANGER
F2	FUSE(T6.3AL250V)	IC801	POWER DEVICE	PTC1,2	CIRCUIT PROTECTION	RT61	TEMPERATURE THERMISTOR
F711	FUSE(T3.15AL250V)	L	REACTOR	RT62	DISCHARGE TEMP. THERMISTOR	T801	TRANSFORMER
HPS	HIGH PRESSURE SWITCH	LED1-3	LED	RT66	LED	TB1-4	REVERSING VALVE SOLENOID COIL

MXZ-3F54VF2 - ET1
MXZ-3F68VF2 - ET1

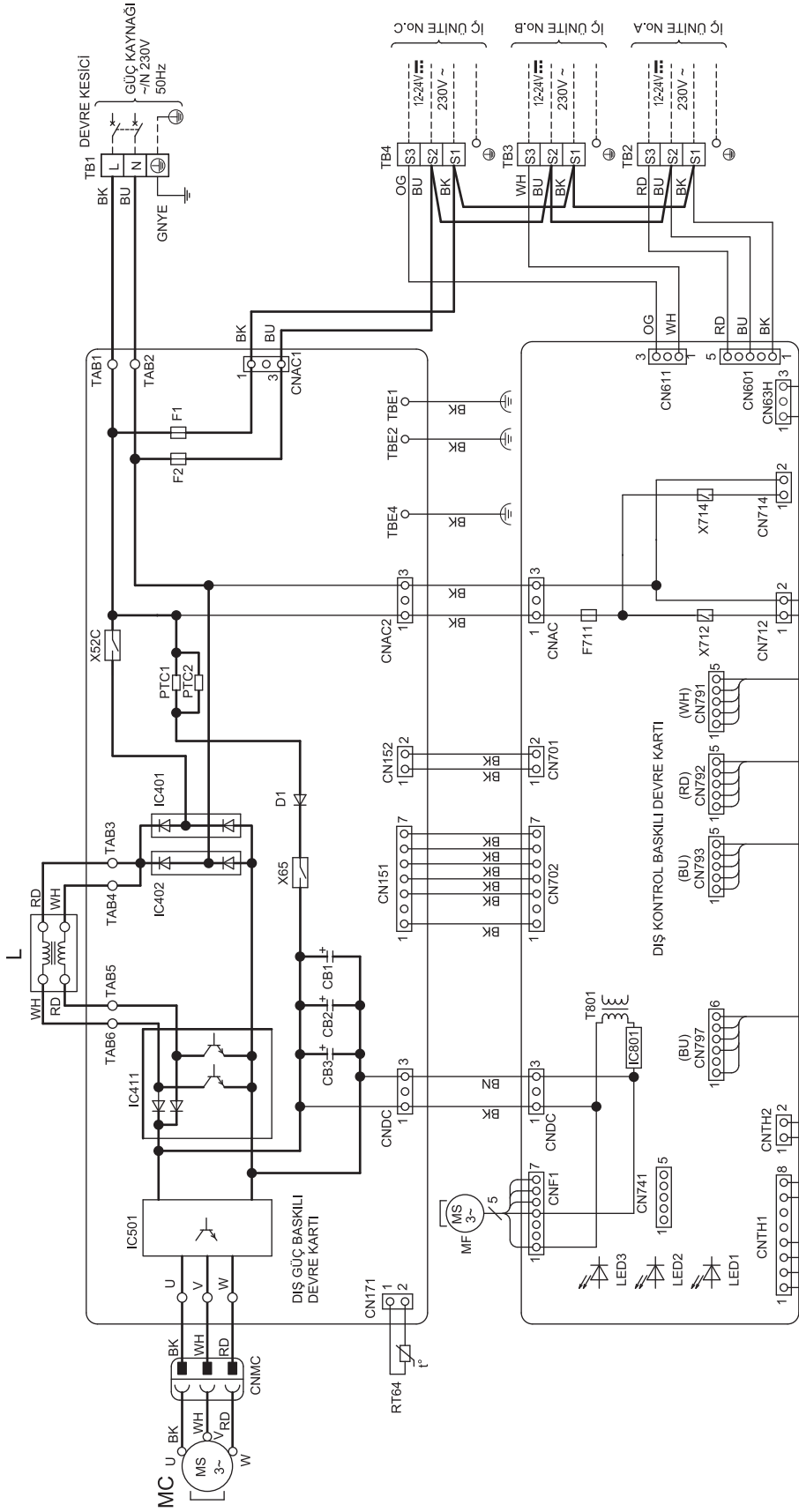

NOTLAR:
1. İç ünite, elektrik devresiyle ilgili bakım için iç ünite elektrik devre şemasını referans alınız.
2. Sadece bakır kablolar kullanın (Saha elektrik devresi için).
3. Sembollerin anlamı:
□: Klemens Grubu
⊞: Konnektör

SEMBOLE	PARÇA ADI	SEMBOLE	PARÇA ADI	SEMBOLE	PARÇA ADI	SEMBOLE	PARÇA ADI
CB1-3	KAPASİTÖR	RT64	GENLEŞME VANASI SARGISI	X52C	FIN SICAKLIK TERMİSTÖRÜ	HPS	PARÇA ADI
D1	DIYOT	MC	KOMPRESÖR	X65	ORTAM SICAKLIK TERMİSTÖRÜ	RÖLE	RÖLE
F1	SİGORTA (T6.3AL250V)	MF	FAN MOTORU	X712	DIŞ ÜNİTE EŞANÖR	RÖLE	RÖLE
F2	SİGORTA (T6.3AL250V)	PTC1,2	DEVRE KORUMASI	X714	SICAKLIK TERMİSTÖRÜ	RÖLE	RÖLE
F711	SİGORTA (T3.15AL250V)	RT61	DEFROST TERMİSTÖRÜ	21S4	TRANSFORMATÖR	21S4	İKİ YÖNLÜ VANA SELENOİD
HPS	YÜKSEK BASINÇ SIVICI	RT62	BASMA SICAKLIK TERMİSTÖRÜ				SARGISI

MXZ-3F54VF3 - E1
MXZ-3F68VF3 - E1

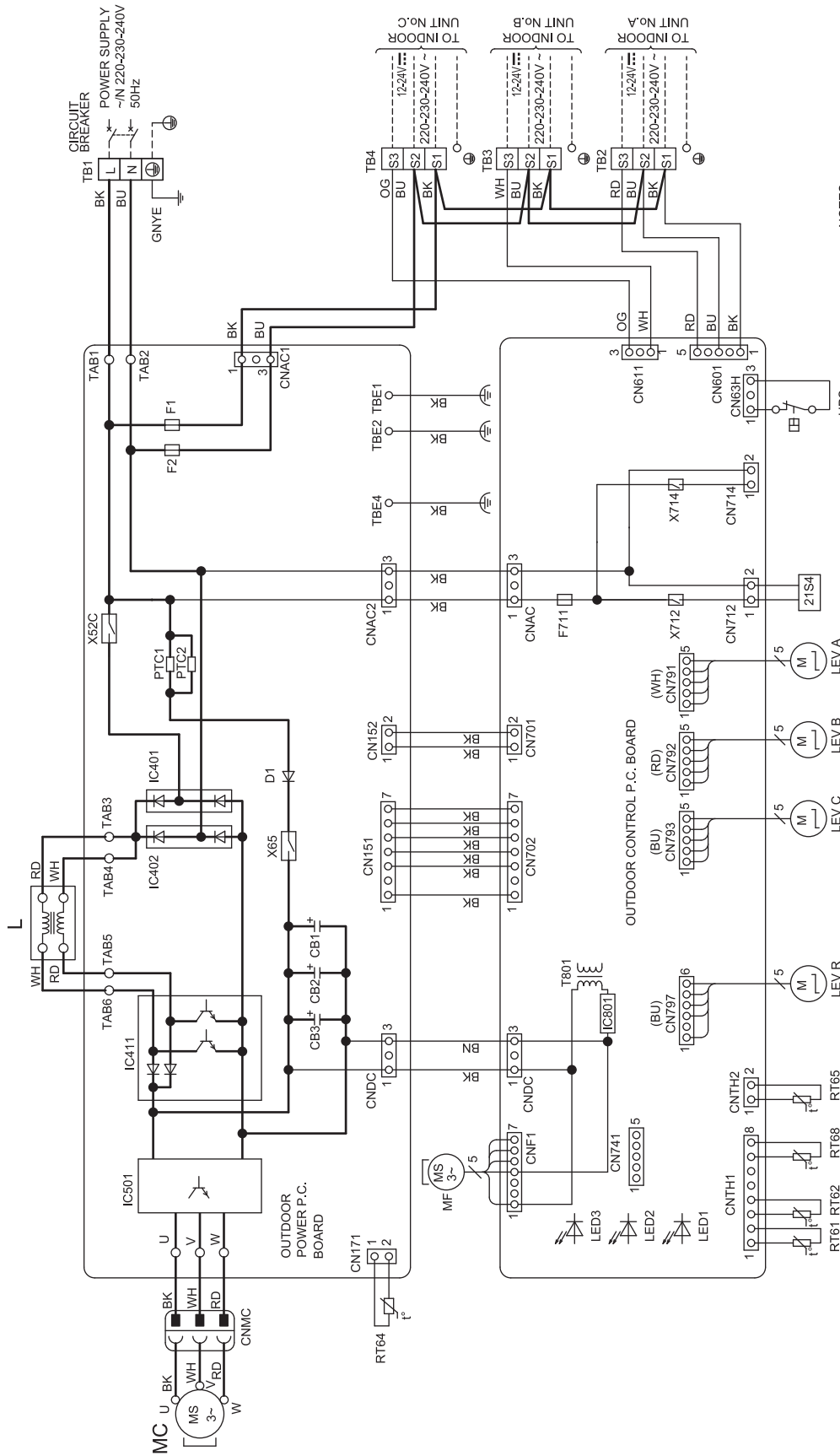

- NOTES:
- About the indoor side electric wiring refer to the indoor unit electric wiring diagram for the service.
 - Use copper conductors only (For field wiring).
 - Symbols below indicate.
 - Terminal block
 - ⊞ Connector

SYMBOL	NAME	SYMBOL	NAME	SYMBOL	NAME	SYMBOL	NAME
CB1-3	SMOOTHING CAPACITOR	IC401,402	DIODE BRIDGE	RT64	FIN TEMP. THERMISTOR	X52C	RELAY
D1	DIODE	IC411	POWER FACTOR CONTROLLER	RT65	AMBIENT TEMP. THERMISTOR	X65	RELAY
F1	FUSE(T6.3AL250V)	IC501	POWER MODULE	RT66	OUTDOOR HEAT EXCHANGER	X712	RELAY
F2	FUSE(T6.3AL250V)	IC801	POWER DEVICE	PTC1,2	CIRCUIT PROTECTOR	X714	RELAY
F3	FUSE(T3.15AL250V)	L	REACTOR	RT801	DEFROST THERMISTOR	TRANSFORMER	REVERSING VALVE
HPS	HIGH PRESSURE SWITCH	LED1-3	LED	RT82	DISCHARGE TEMP. THERMISTOR	TB1-4	TERMINAL BLOCK
						21S4	SOLENOID COIL

MXZ-3F54VF3 - [ET1]
MXZ-3F68VF3 - [ET1]

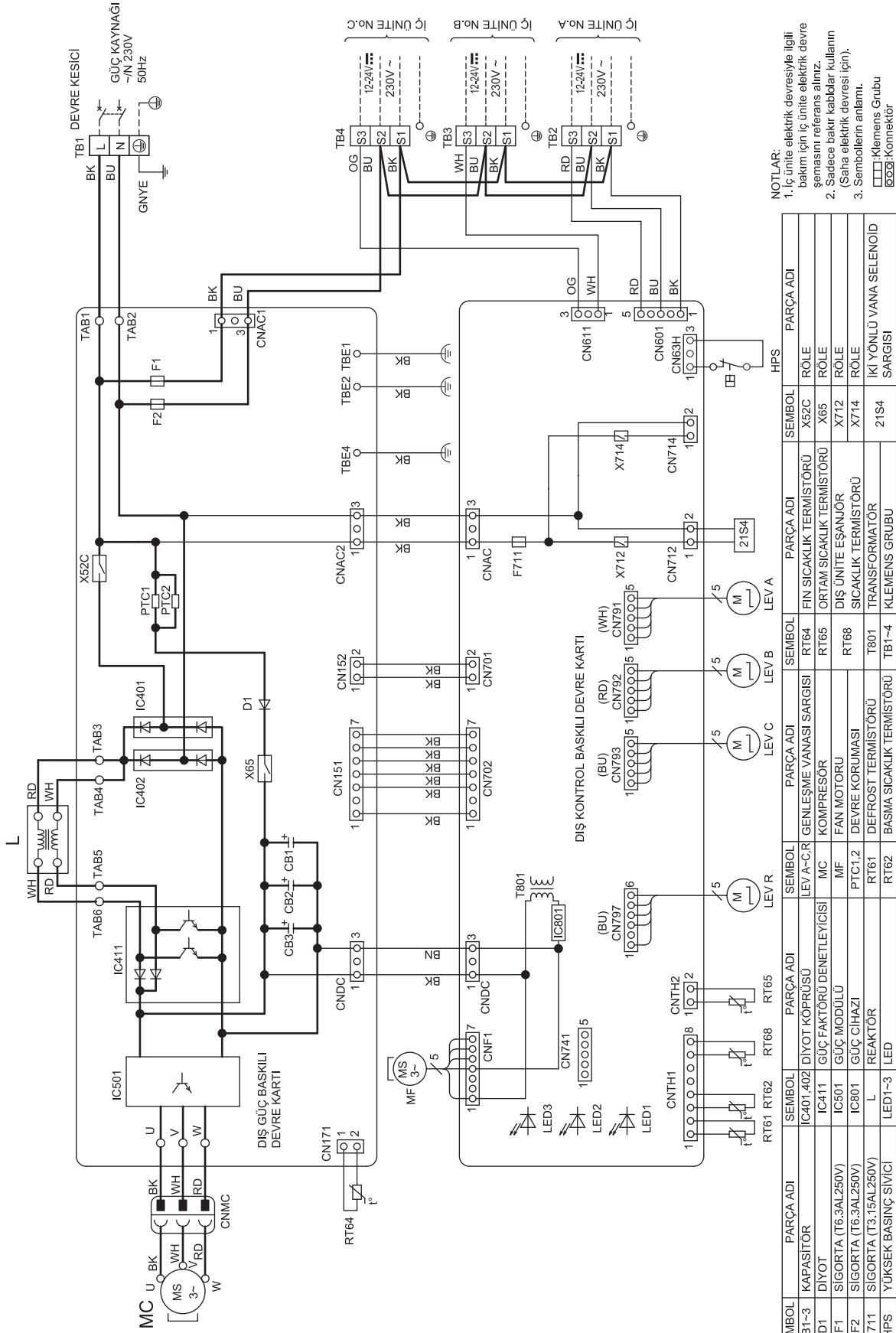

NOTLAR:
1. İç ünite elektrik devresiyle ilgili bakım için iç ünite elektrik devre şemasını referans alınız.
2. Sadece bakır kablolar kullanın (Saha elektrik devresi için).
3. Sembollerin anlamı:
□□□:Klemens Grubu
□□□□:Konnektör

SEMBOLE	PARÇA ADI	SEMBOLE	PARÇA ADI	SEMBOLE	PARÇA ADI	SEMBOLE	PARÇA ADI
CB1-3	KAPASİTÖR	IC401,402	DIYOT KÖPRÜSÜ	LEV A-C-R	GENLEŞME VANASI SARGISI	RT64	FIN SICAKLIK TERMİSTÖRÜ
D1	DIYOT	IC411	GÜÇ FAKTÖRÜ DENEYİCİSİ	MC	KOMPRESÖR	RT65	ORTAM SICAKLIK TERMİSTÖRÜ
F1	SİGORTA (T6.3AL250V)	IC501	GÜÇ MODÜLÜ	MF	FAN MOTORU	RT66	DIŞ ÜNİTE EŞANJÖR SICAKLIK TERMİSTÖRÜ
F2	SİGORTA (T6.3AL250V)	IC801	GÜÇ CHAZI	PTC1,2	DEVRE KORUMASI	RT68	SICAKLIK TERMİSTÖRÜ
F711	SİGORTA (T3.15AL250V)	L	REAKTÖR	RT61	DEFROST TERMİSTÖRÜ	T801	TRANSFORMATÖR
HPS	YÜKSEK BASINÇ SVİÇİ	LED1-3	LED	RT62	BASMA SICAKLIK TERMİSTÖRÜ	TB1-4	KLEMENS GRUBU SARGISI

MXZ-4F72VF - E1, ET1, E2, ET2

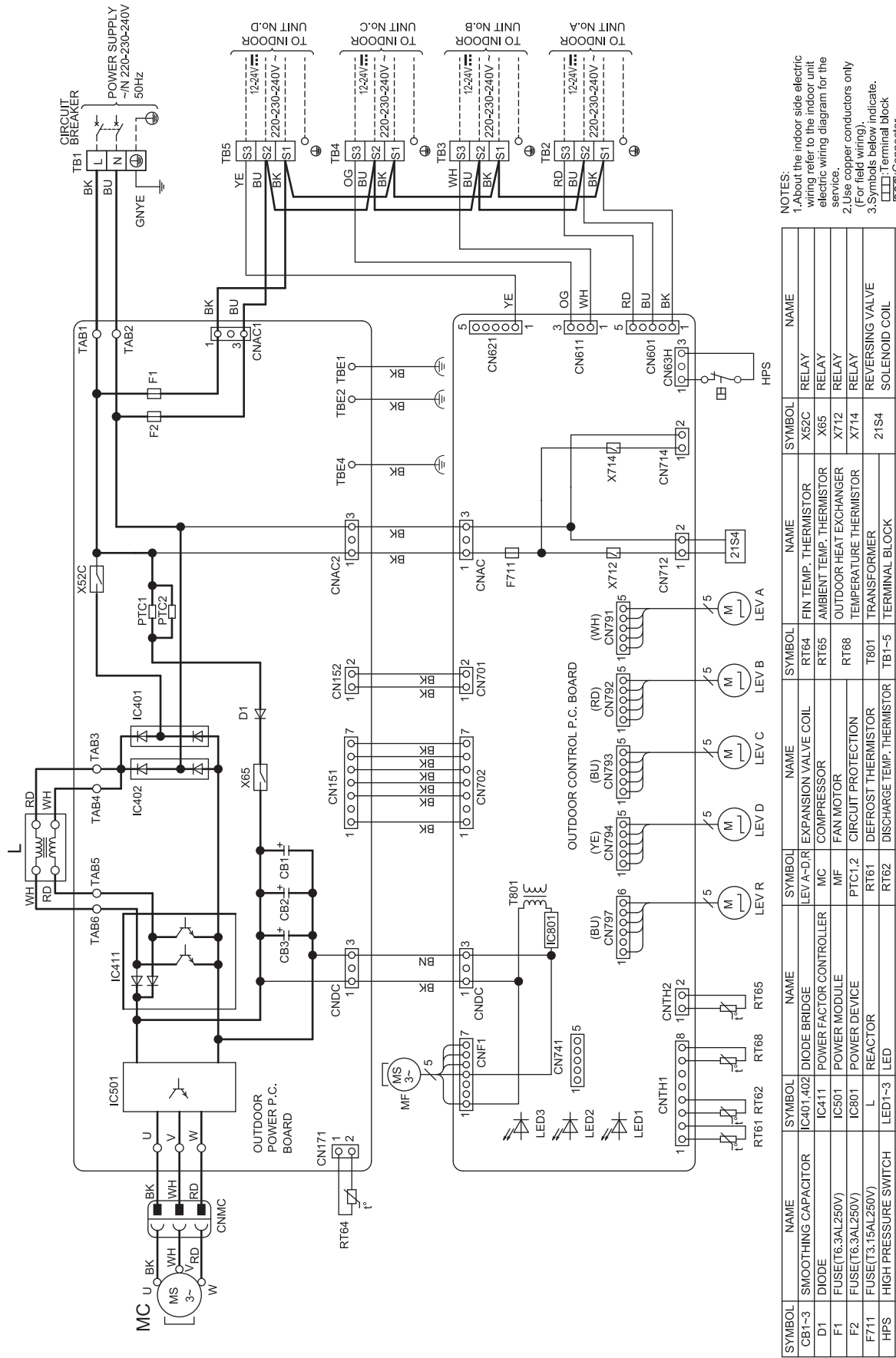

NOTES:
 1.About the indoor side electric wiring refer to the indoor unit electric wiring diagram for the service.
 2.Use copper conductors only (For field wiring).
 3.Symbols below indicate.
 □□□□: Terminal block
 □□□□: Connector

MXZ-4F72VF2 - E1
MXZ-4F80VF2 - E1

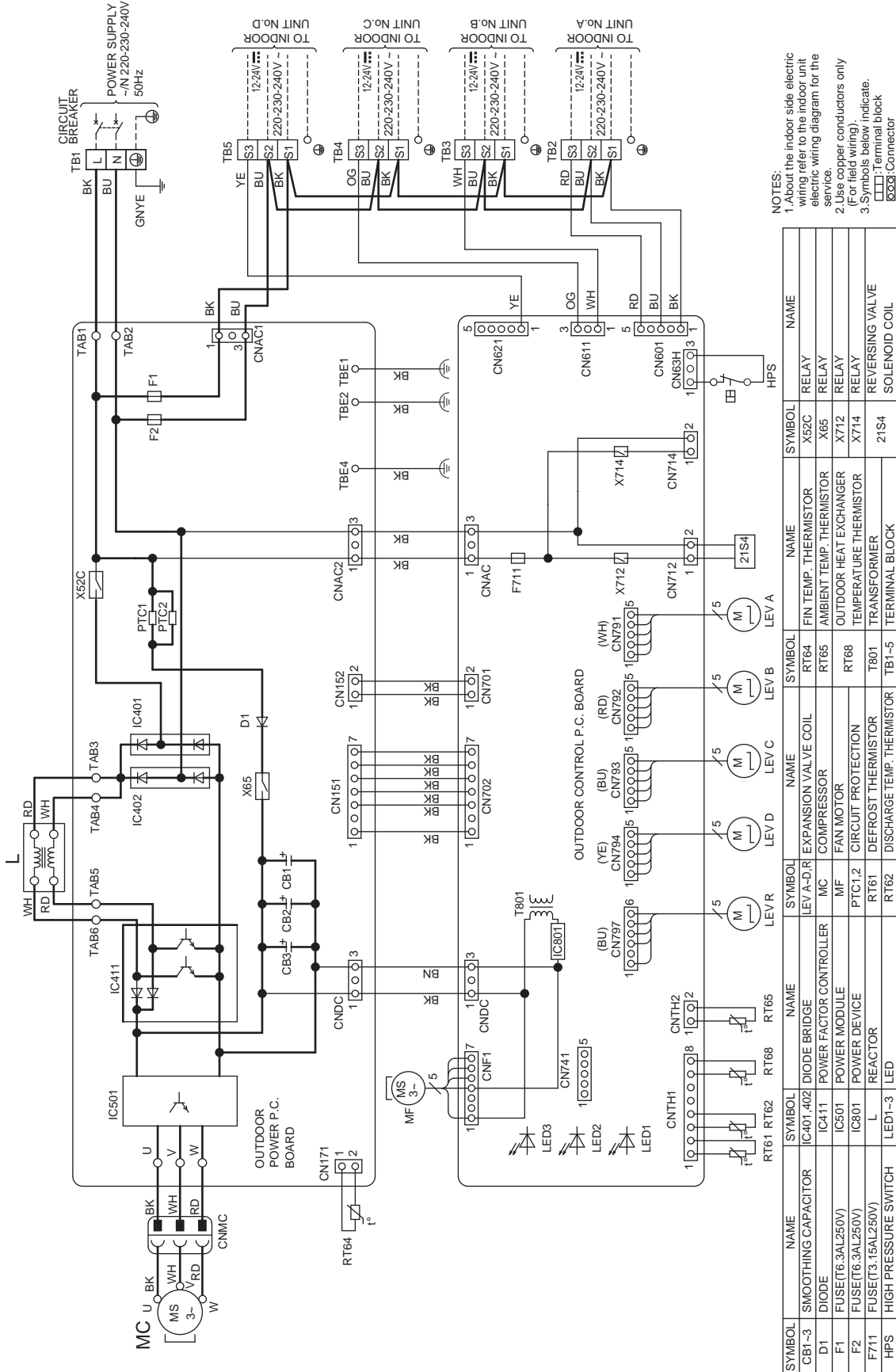

- NOTES:**
- About the indoor side electric wiring refer to the indoor unit electric wiring diagram for the service.
 - Use copper conductors only (For field wiring).
 - Symbols below indicate:
 - Terminal block
 - Connector

MXZ-4F72VF2 - [ET1]
MXZ-4F80VF2 - [ET1]

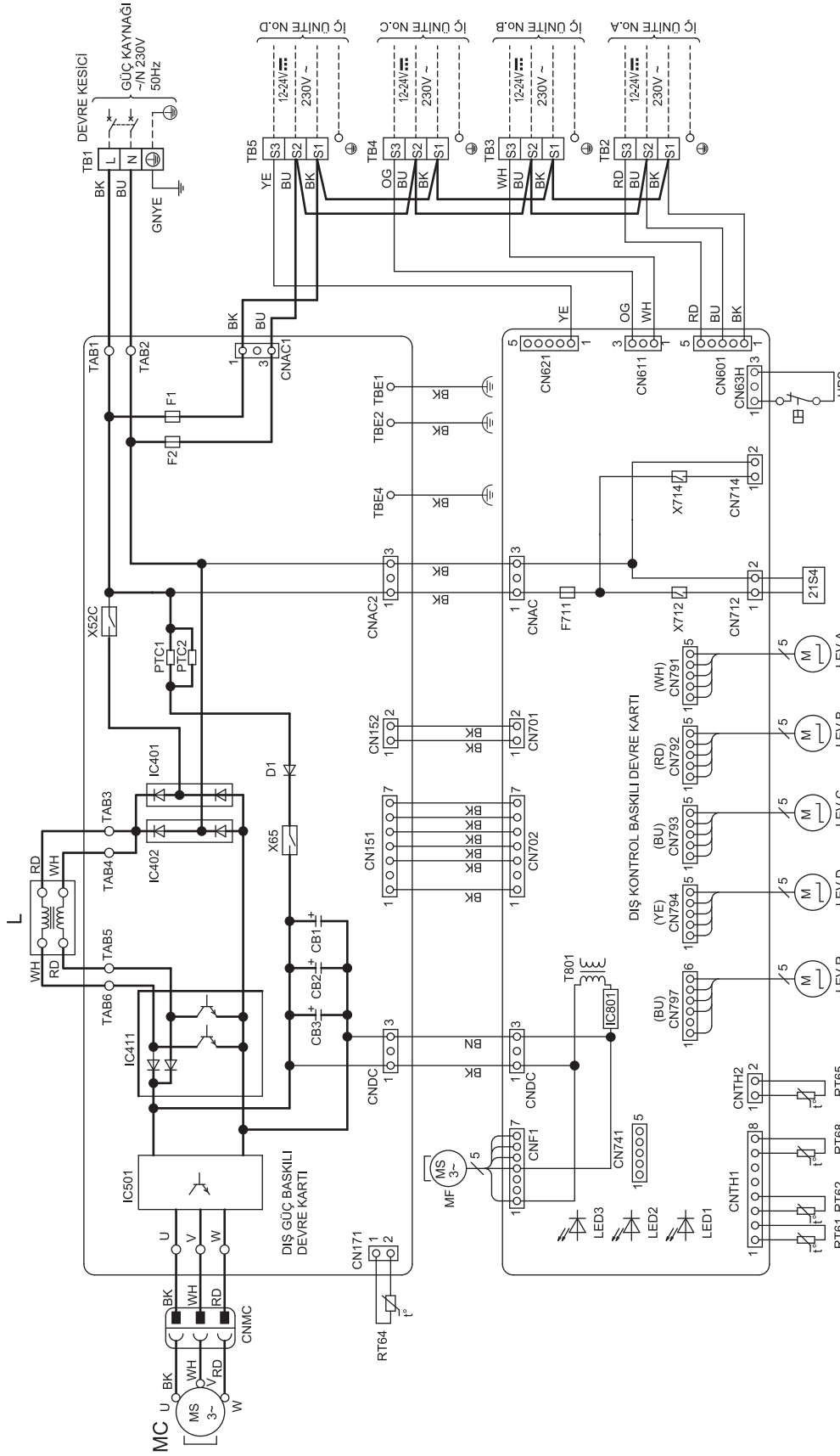

NOTLAR:
1. İç ünite elektrik devresiyle ilgili bakım için iç ünite elektrik devre şemasını referans alın.
2. Sadece bakır kablolar kullanın (Saha elektrik devresi için).
3. Sembollerin anlamı.
□□□: Klemens Grubu
□□□□: Konnektör

SEMBOLE	PARÇA ADI	SEMBOLE	PARÇA ADI	SEMBOLE	PARÇA ADI
CB1-3	KAPASİTÖR	IC401,402	DIYOT KÖPRÜSÜ	RT64	GENLEŞME VANAŞI SARGISI
D1	DIYOT	IC411	GÜÇ FAKTÖRÜ DENETLEYİCİSİ	MC	KOMPRESÖR
F1	SİGORTA (T6.3AL250V)	IC501	GÜÇ MODÜLÜ	MF	FAN MOTORU
F2	SİGORTA (T6.3AL250V)	IC801	GÜÇ CİHAZI	PTC1,2	DEVRE KORUMASI
F711	SİGORTA (T3.15AL250V)	L	REAKTÖR	RT61	DEFROST TERMİSTÖRÜ
HPS	YÜKSEK BASINÇ SIVICI	LED1-3	LED	RT62	BASMA SICAKLIK TERMİSTÖRÜ
				TB1-5	KLEMENS GRUBU
				21S4	SARGISI
				X52C	FIN SICAKLIK TERMİSTÖRÜ
				X65	RÖLE
				X72	ORTAM SICAKLIK TERMİSTÖRÜ
				X74	DIŞ ÜNİTE EŞANJÖR SICAKLIK TERMİSTÖRÜ
				X714	RÖLE
				21S4	RÖLE

MXZ-4F72VF3 - E1
MXZ-4F80VF3 - E1

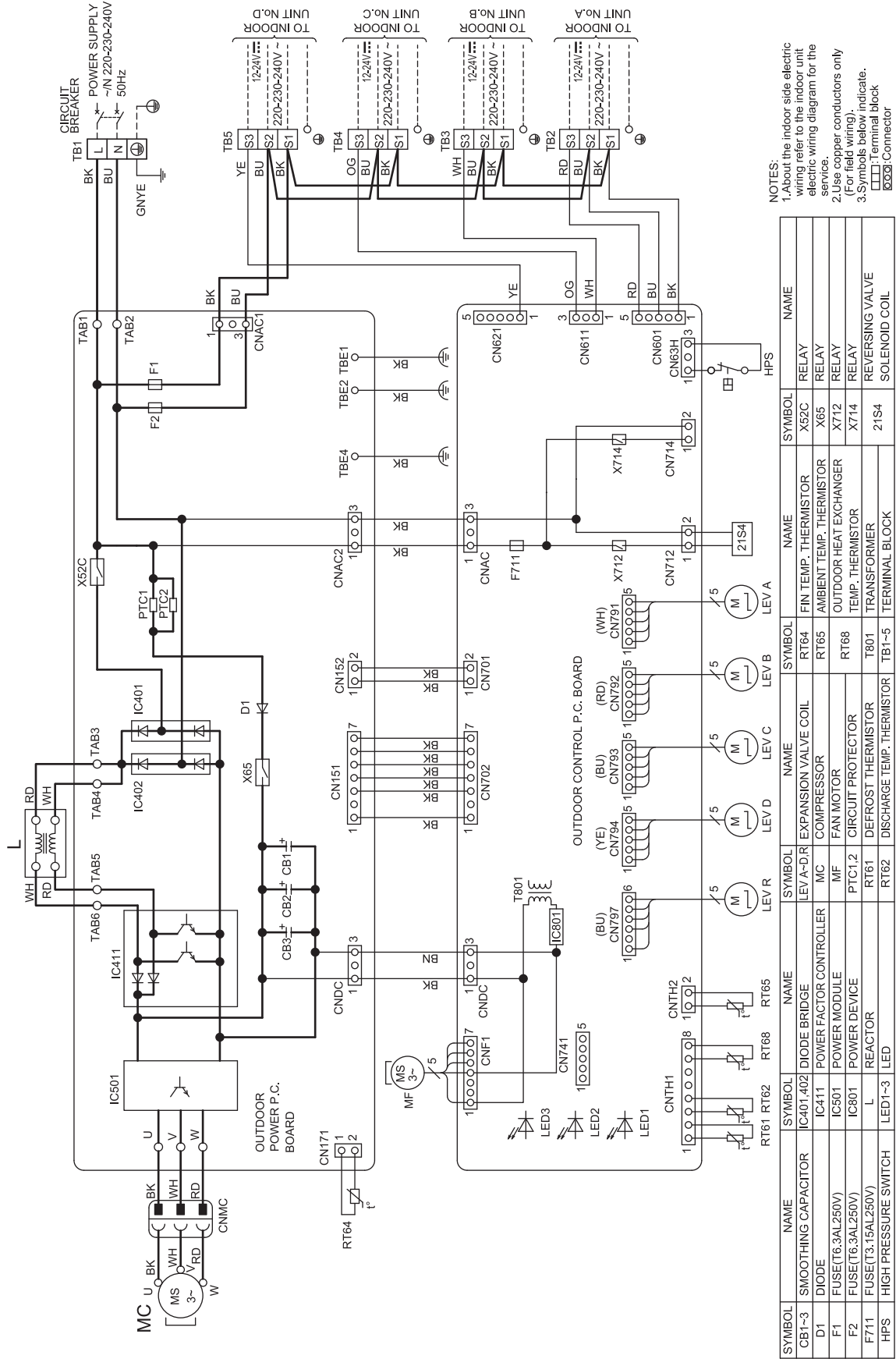

MXZ-4F72VF3 - ET1
MXZ-4F80VF3 - ET1

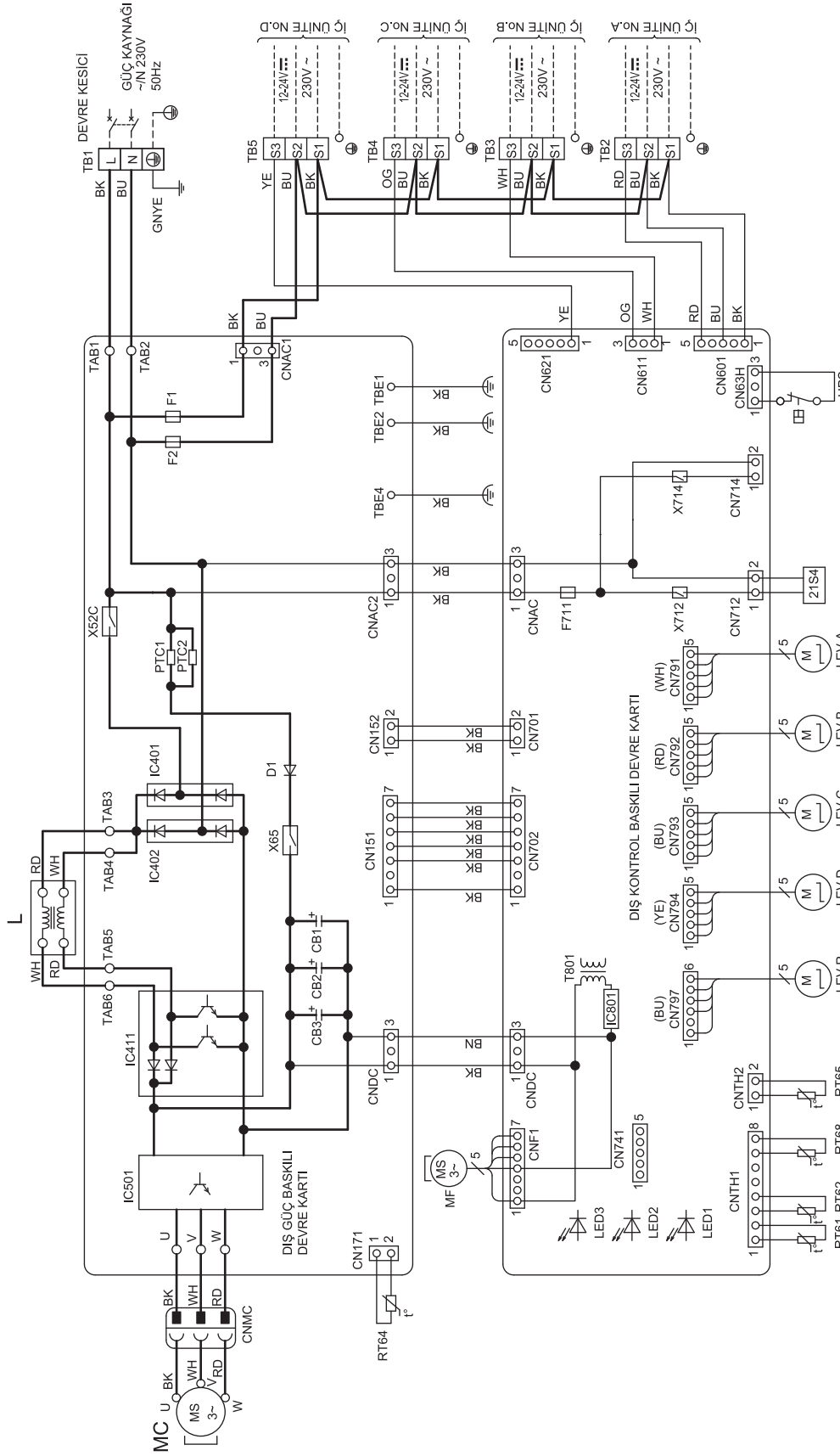

NOTLAR:
1. İç ünite elektrik devresine ilgili bakım için iç ünite elektrik devre şemasını referans alın.
2. Sadece bakır kablolar kullanın (Saha elektrik devresi için).
3. Sembollerin anlamı:
□ □ □ □ Klemens Grubu
□ □ □ □ Konnektör

SEMBOLE	PARÇA ADI	SEMBOLE	PARÇA ADI	SEMBOLE	PARÇA ADI
CB1-3	KAPASİTÖR	IC401,402	DIYOT KÖPRÜSÜ	RT64	GENLEŞME VANASI SARGISI
D1	DIYOT	IC411	GÜÇ FAKTÖRÜ DENEYLEYİCİSİ	RT65	KOMPRESÖR
F1	SİGORTA (T6.3AL250V)	IC501	GÜÇ MODÜLÜ	MC	FAN MOTORU
F2	SİGORTA (T6.3AL250V)	IC801	GÜÇ CİHAZI	PTC1,2	DEVRE KORUMASI
F711	SİGORTA (T3.15AL250V)	L	REAKTÖR	RT61	DEFROST TERMİSTÖRÜ
HPS	YÜKSEK BASINÇ SIVICI	LED1-3	LED	RT62	BASMA SICAKLIK TERMİSTÖRÜ
				TB1-5	KLEMENS GRUBU
				RT66	İKİ YÖNLÜ VANA SELENOİD
				RT67	TRANSFORMATÖR
				RT68	SARGISI
				RT69	LEV A
				RT70	LEV B
				RT71	LEV C
				RT72	LEV D
				RT73	LEV E
				RT74	LEV F
				RT75	LEV G
				RT76	LEV H
				RT77	LEV I
				RT78	LEV J
				RT79	LEV K
				RT80	LEV L
				RT81	LEV M
				RT82	LEV N
				RT83	LEV O
				RT84	LEV P
				RT85	LEV Q
				RT86	LEV R
				RT87	LEV S
				RT88	LEV T
				RT89	LEV U
				RT90	LEV V
				RT91	LEV W
				RT92	LEV X
				RT93	LEV Y
				RT94	LEV Z
				RT95	LEV AA
				RT96	LEV AB
				RT97	LEV AC
				RT98	LEV AD
				RT99	LEV AE
				RT100	LEV AF

MXZ-4F83VF - E1

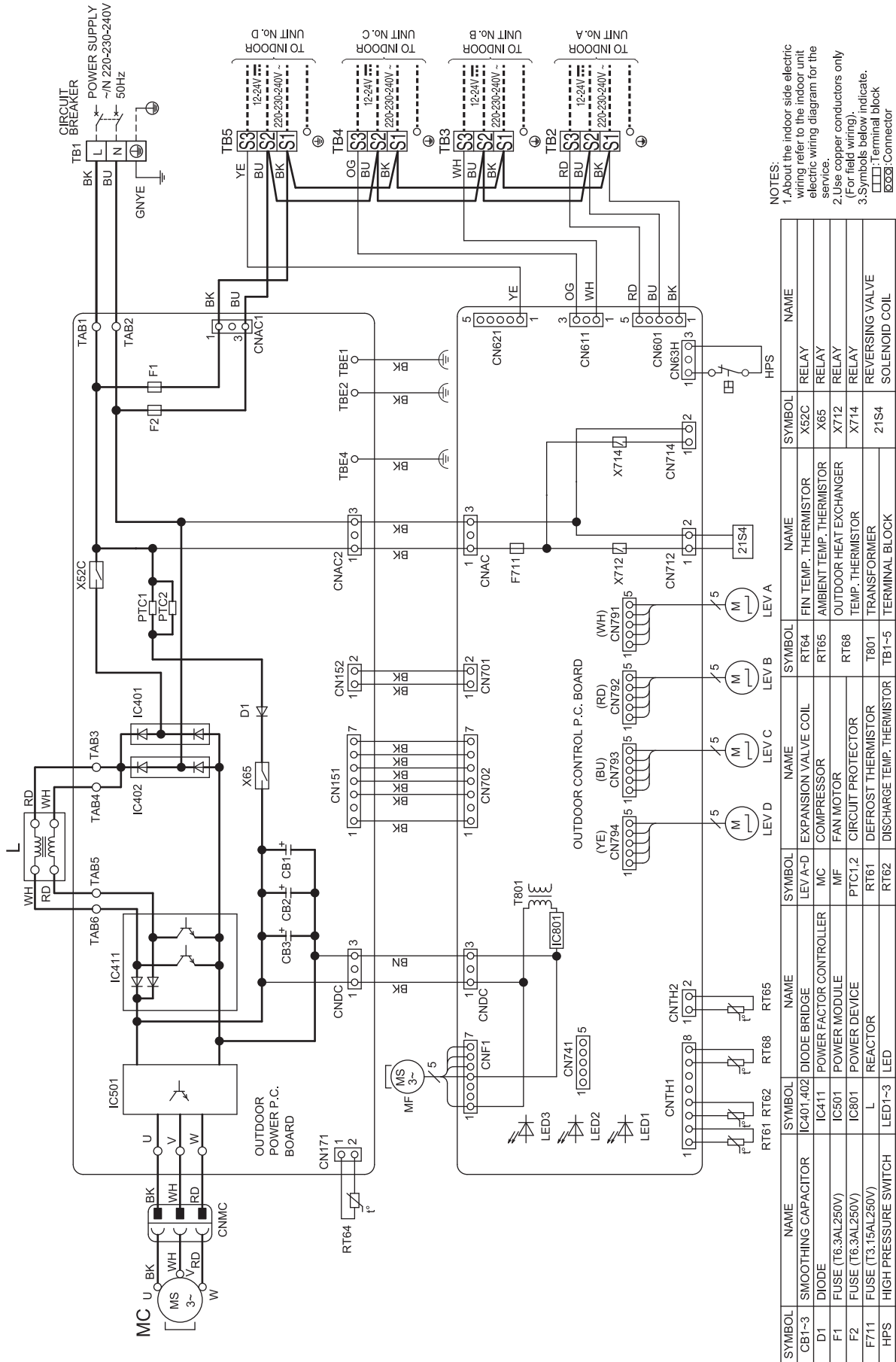

NOTES:
 1>About the indoor side electric wiring refer to the indoor unit electric wiring diagram for the service.
 2.Use copper conductors only (For field wiring).
 3.Symbols below indicate.
 □□□□:Terminal block
 □□□□:Connector

SYMBOL	NAME	SYMBOL	NAME	SYMBOL	NAME	SYMBOL	NAME
CB1-3	SMOOTHING CAPACITOR	LEV A-D	EXPANSION VALVE COIL	X52C	RELAY	X65	RELAY
D1	DIODE	MC	COMPRESSOR	RT65	AMBIENT TEMP. THERMISTOR	X712	RELAY
F1	FUSE (T6.3AL250V)	MF	FAN MOTOR	RT68	OUTDOOR HEAT EXCHANGER TEMP. THERMISTOR	X714	RELAY
F2	FUSE (T6.3AL250V)	PTC1,2	CIRCUIT PROTECTOR	T801	TRANSFORMER	21S4	SOLENOID COIL
F711	FUSE (T3.15AL250V)	RT61	DEFROST THERMISTOR	TB1-5	TERMINAL BLOCK		
HPS	HIGH PRESSURE SWITCH	RT62	DISCHARGE TEMP. THERMISTOR				

MXZ-4F83VF - [ET1]

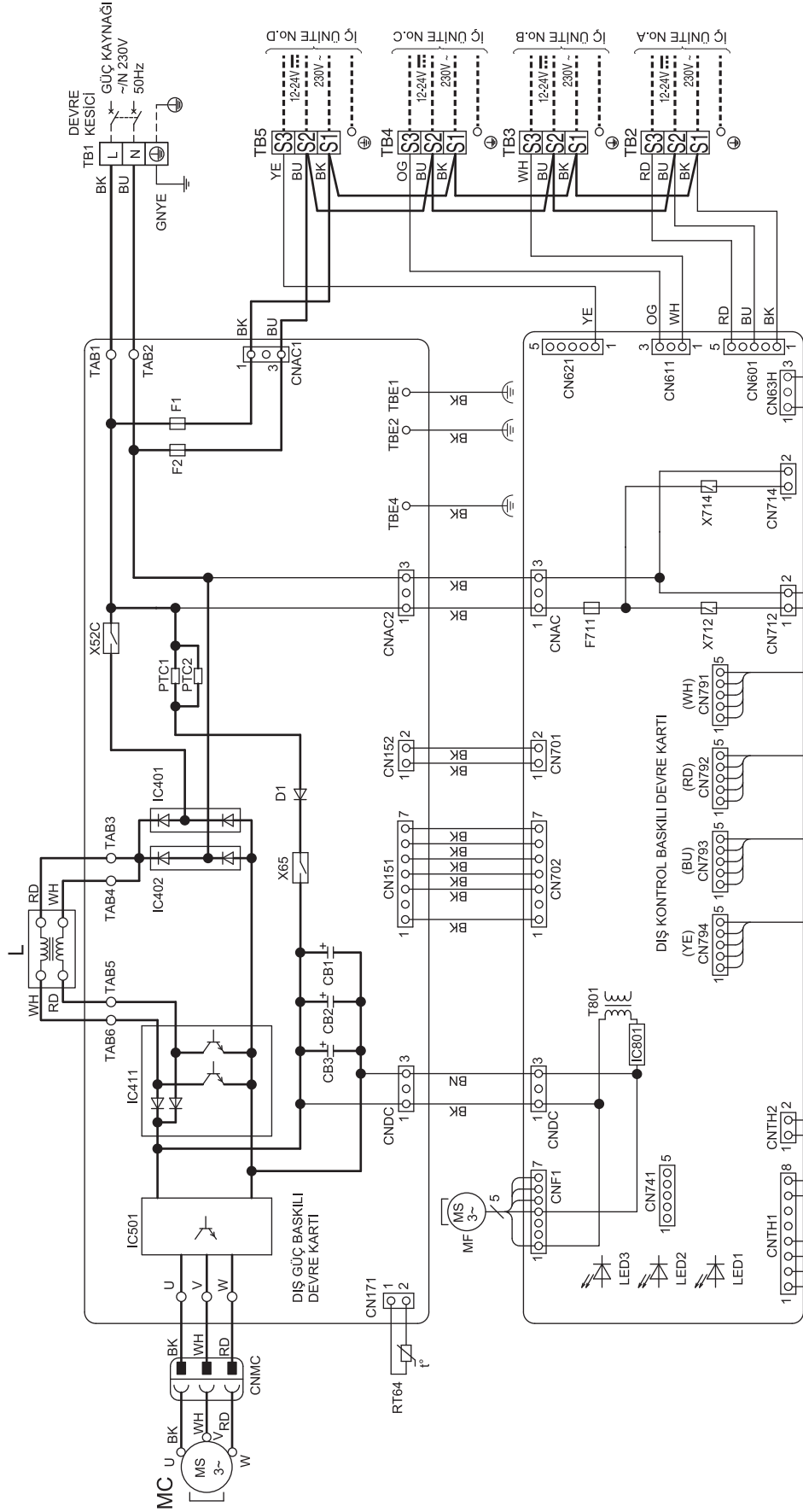

NOTLAR:
 1. İç ünite elektrik devresiyle ilgili bakım için iç ünite elektrik devre şemasını referans alınınız.
 2. Sadece bakır kablolar kullanın
 3. (Saha elektrik devresi için).
 Sembollerin anlamları:
 □: Klemens Grubu
 ○: Konektör

SEMBOL	PARÇA ADI	SEMBOL	PARÇA ADI	SEMBOL	PARÇA ADI	SEMBOL	PARÇA ADI
CB1-3	KAPASİTÖR	LEV A-D	GENİŞLEME VANASI SARGISI	RT64	FIN SICAKLIK TERMİSTÖRÜ	X52C	RÖLE
D1	DIYOT	MC	KOMPRESÖR	RT65	ORTAM SICAKLIK TERMİSTÖRÜ	X65	RÖLE
F1	SİGORTA (T6.3AL250V)	MF	FAN MOTORU	RT68	DIŞ ÜNİTE EŞANJÖR	X712	RÖLE
F2	SİGORTA (T6.3AL250V)	PTC1,2	GÜÇ KORUMASI	T801	SICAKLIK TERMİSTÖRÜ	X714	RÖLE
F711	SİGORTA (T3.15AL250V)	RT61	DEFROST TERMİSTÖRÜ	T801	TRANSFORMATÖR		İKİ YÖNLÜ VANA SELENOİD
HPS	YÜKSEK BASINÇ SIVICI	RT62	BASMA SICAKLIK TERMİSTÖRÜ	TB1-5	KLEMENS GRUBU	21S4	SARGISI

MXZ-5F102VF - E1

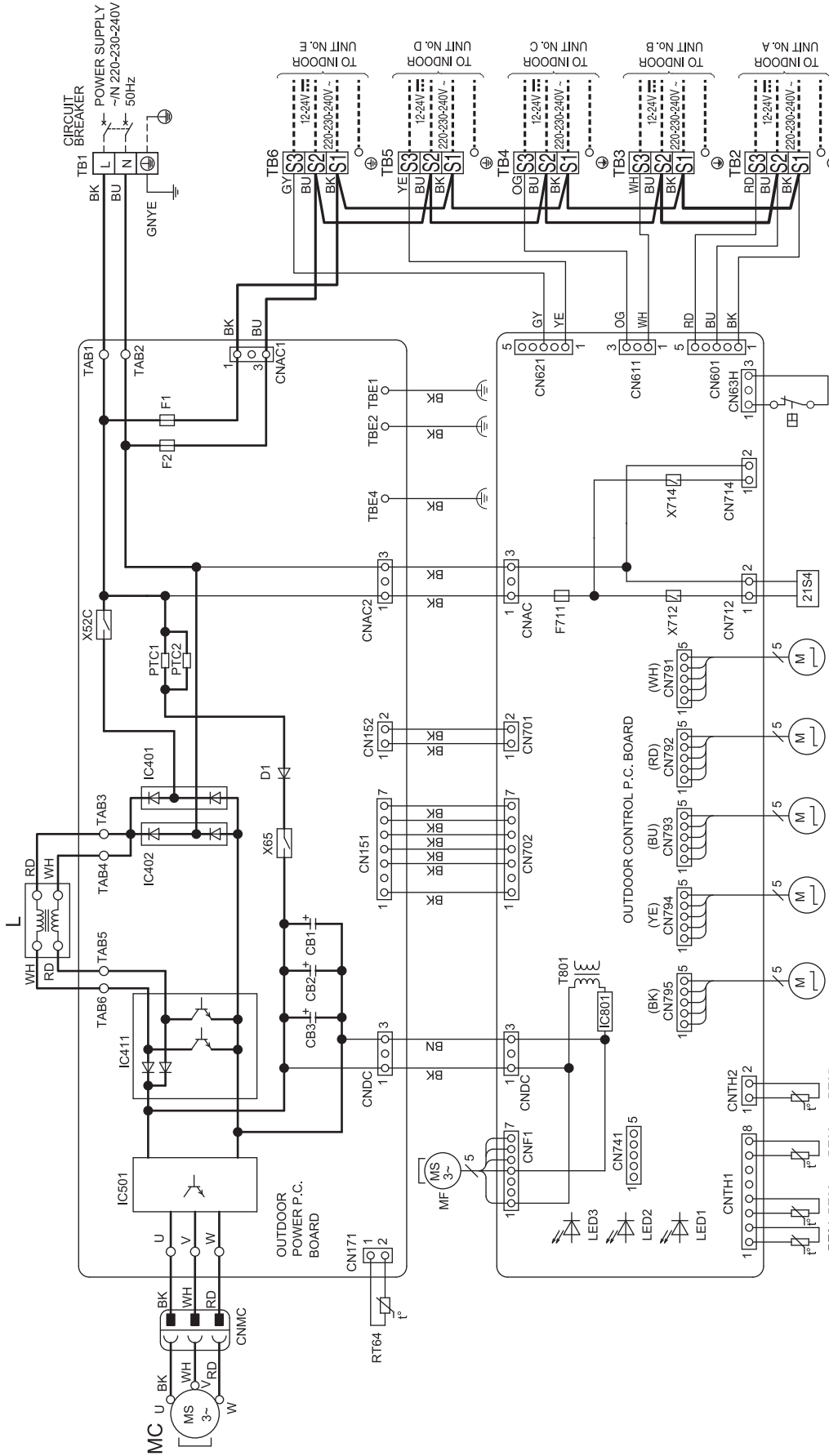

NOTES:
 1. About the indoor side electric wiring refer to the indoor unit electric wiring diagram for the service.
 2. Use copper conductors only (For field wiring).
 3. Symbols below indicate.
 □: Terminal block
 ○: Connector

SYMBOL	NAME	SYMBOL	NAME	SYMBOL	NAME
CB1-3	SMOOTHING CAPACITOR	IC401,402	DIODE BRIDGE	X52C	RELAY
D1	DIODE	MC	POWER FACTOR CONTROLLER	X65	RELAY
F1	FUSE(T6.3AL250V)	MF	POWER MODULE	X712	RELAY
F2	FUSE(T6.3AL250V)	PTC1,2	POWER DEVICE	X714	RELAY
F711	FUSE(T3.15AL250V)	L	REACTOR	TRANSFORMER	REVERSING VALVE
HPS	HIGH PRESSURE SWITCH	LED1-3	LED	21S4	SOLENOID COIL
		LEV A-E	LEV A-E		
		LEV A	EXPANSION VALVE COIL		
		LEV B	COMPRESSOR		
		LEV C	FAN MOTOR		
		LEV D	CIRCUIT PROTECTOR		
		LEV E	DEFROST THERMISTOR		
			DISCHARGE TEMP. THERMISTOR		

MXZ-5F102VF - ET1

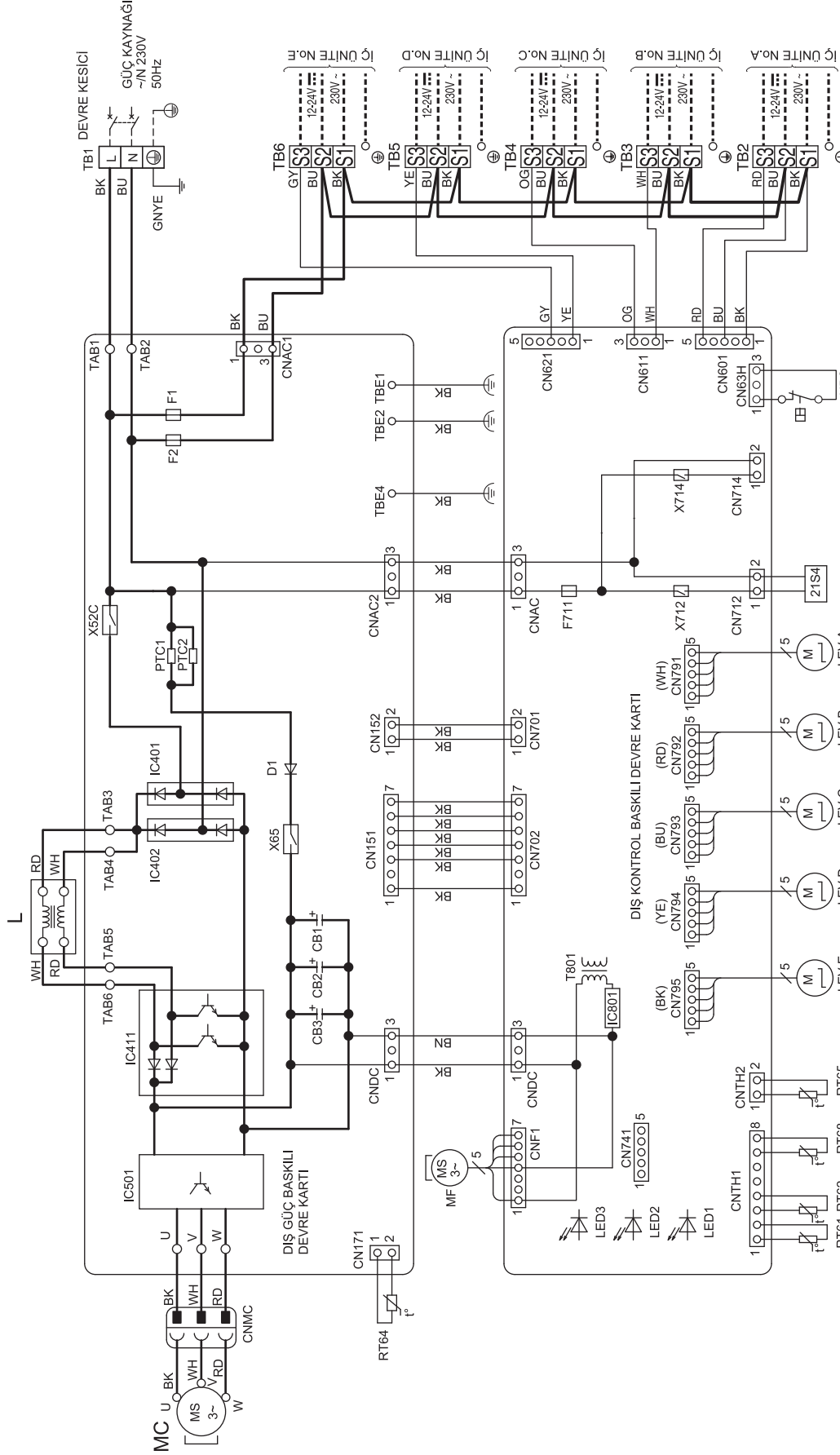

- NOTLAR:**
1. İç ünite elektrik devresiyle ilgili bakım için iç ünite elektrik devre şemasını referans alın.
 2. Sadece bakır kablolar kullanın (Saha elektrik devresi için).
 3. Sembollerin anlamı:
 : Klemens Grubu
 : Konnektör

SEMBOL	PARÇA ADI	SEMBOL	PARÇA ADI	SEMBOL	PARÇA ADI
CB1-3	KAPASİTÖR	IC401,402	DİYOT KÖPRÜSÜ	LEV A-E	GENLEŞME VANASI SARGISI
D1	DİYOT	IC411	GÜÇ FAKTÖRÜ DENETLEYİCİSİ	MC	KOMPRESÖR
F1	SİGORTA (T6.3AL250V)	IC501	GÜÇ MODÜLÜ	MF	FAN MOTORU
F2	SİGORTA (T6.3AL250V)	IC801	GÜÇ CİHAZI	PTC1,2	DEVRE KORUMASI
F711	SİGORTA (T3.15AL250V)	L	REAKTÖR	RT61	DEFROST TERMİSTÖRÜ
HPS	YÜKSEK BASINÇ SIVICI	LED1-3	LED	RT62	BASMA SICAKLIK TERMİSTÖRÜ
				LEV A	LEV B
				LEV C	LEV D
				LEV E	

MXZ-6F122VF - E1

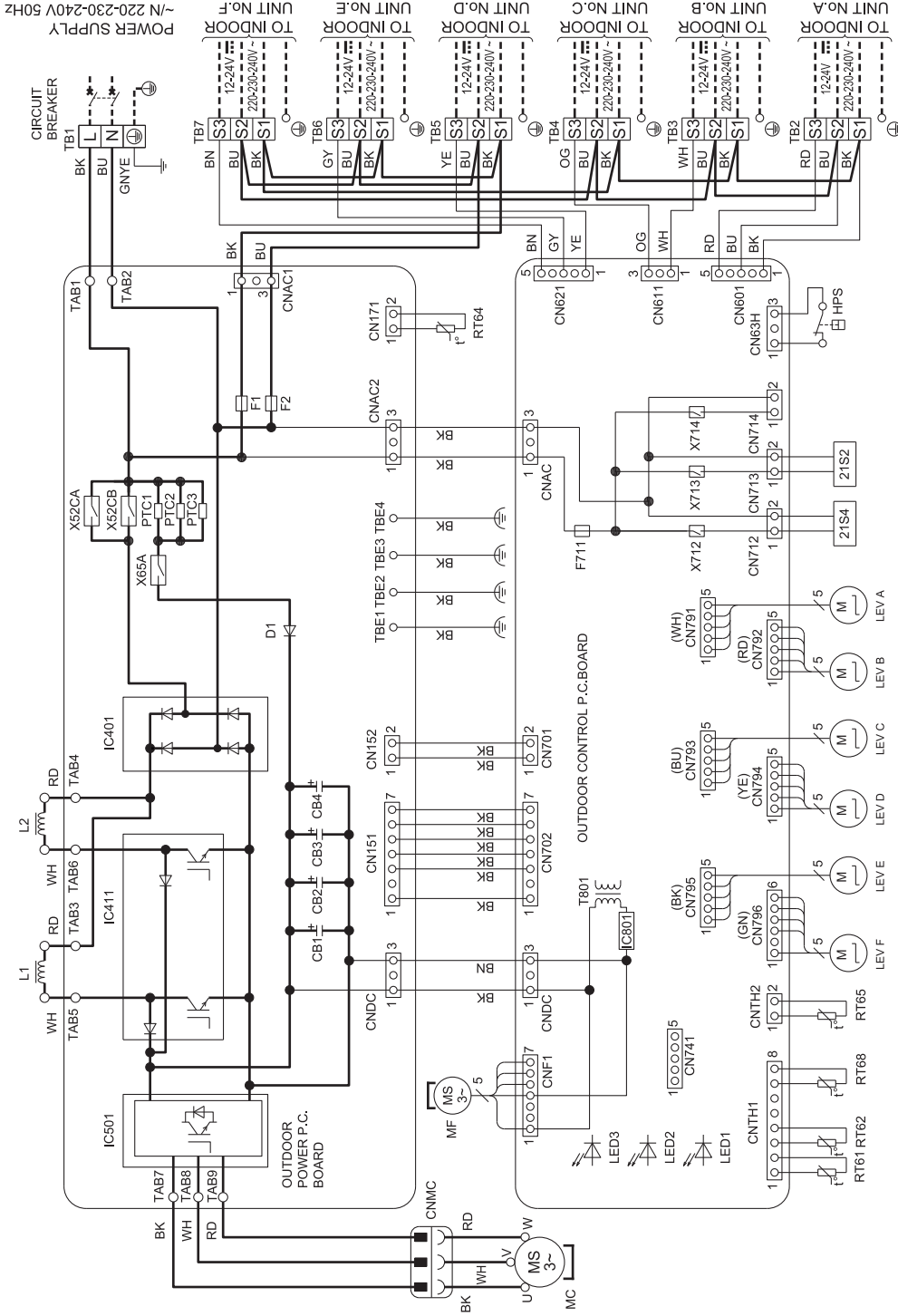

- NOTES:**
1. About the indoor side electric wiring refer to the indoor unit electric wiring diagram for the service.
 2. Use copper conductors only (For field wiring).
 3. Symbols below indicate.
□ : Terminal block
□ : Connector

SYMBOL	NAME	SYMBOL	NAME
CB1-4	SMOOTHING CAPACITOR	RT61	DEFROST THERMISTOR
D1	DIODE	RT62	DISCHARGE TEMP.THERMISTOR
F1,F2	FUSE(T6.3AL250V)	RT64	FIN TEMP.THERMISTOR
F711	FUSE(T3.15AL250V)	RT65	AMBIENT TEMP.THERMISTOR
HPS	HIGH PRESSURE SWITCH	RT68	OUTDOOR HEAT EXCHANGER TEMP. THERMISTOR
IC401	DIODE BRIDGE	T801	TRANSFORMER
IC501	POWER MODULE	TB1-7	TERMINAL BLOCK
IC801	POWER DEVICE	X52CA,B	RELAY
L1,L2	REACTOR	X65A	RELAY
LED1-3	LED	X712	RELAY
LEV A-F	EXPANSION VALVE COIL	X713	RELAY
MC	FAN MOTOR	X714	RELAY
MF	FAN MOTOR	21S2	2WAY VALVE SOLENOID COIL
PTC1-3	CIRCUIT PROTECTOR	21S4	REVERSING VALVE SOLENOID COIL

MXZ-6F122VF - [ET1]

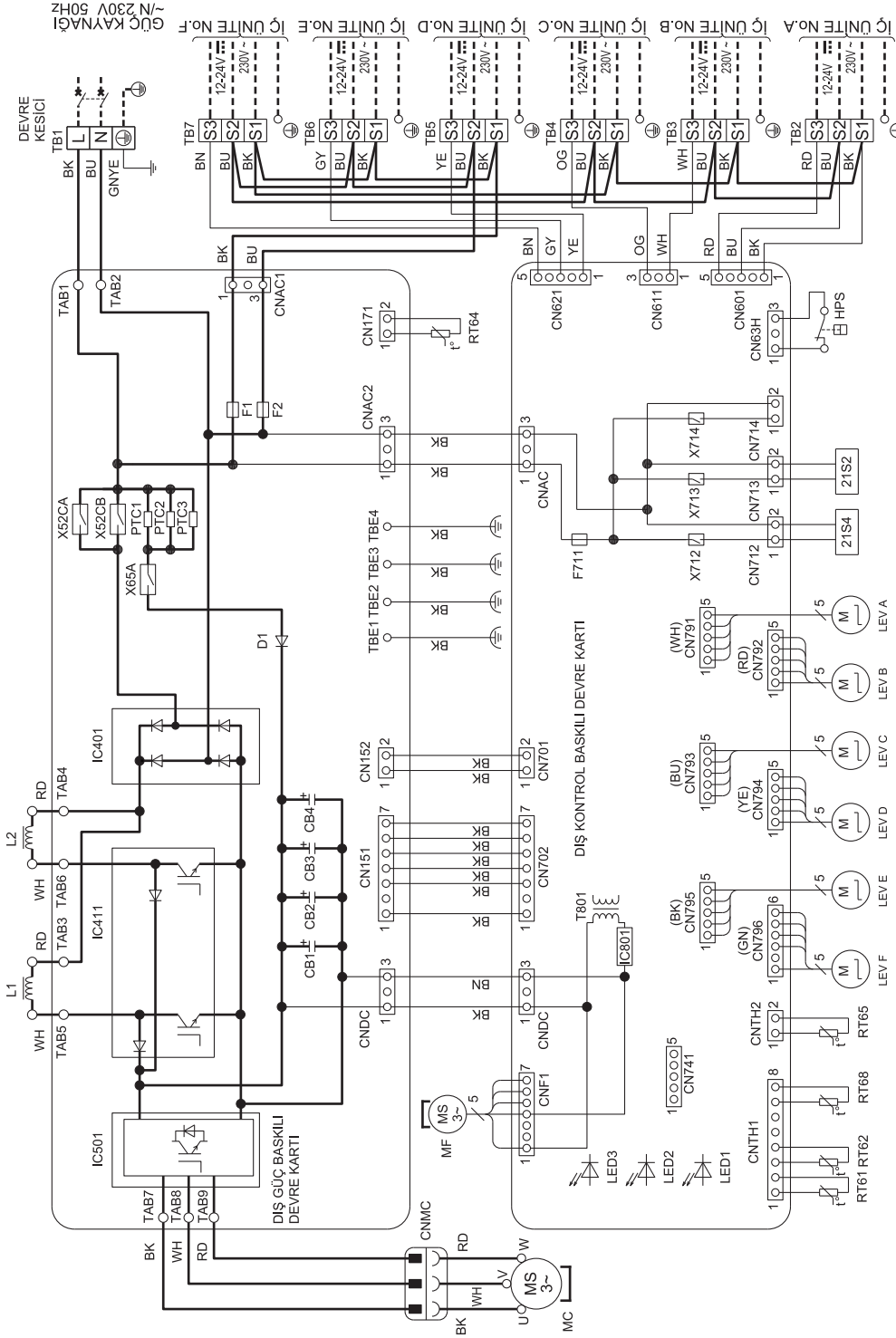

- NOTLAR:
1. İç ünite elektrik devresiyle ilgili bakım için iç ünite elektrik devre şemasını referans alın.
 2. Sadece bakır kablolar kullanın (Saha elektrik devresi için).
 3. Sembollerin anlamı:
 :Klemens Grubu
 :Konnektör

SEMBOLE	PARÇA ADI	SEMBOLE	PARÇA ADI
CB1-4	KAPASİTÖR	RT61	DEFROST TERMİSTÖRÜ
D1	DIYOT	RT62	BASMA SICAKLIK TERMİSTÖRÜ
F1,F2	SİGORTA (T6,3AL250V)	RT64	FIN SICAKLIK TERMİSTÖRÜ
F711	SİGORTA (T3,15AL250V)	RT65	ORTAM SICAKLIK TERMİSTÖRÜ
HPS	YÜKSEK BASINÇ SIVICI	RT68	DIŞ ÜNİTE EŞANJÖR
IC401	DIYOT KÖPRÜSÜ	RT69	SICAKLIK TERMİSTÖRÜ
IC411	GÜÇ FAKTÖRÜ DENETLEYİCİSİ	T801	TRANSFORMATÖR
IC501	GÜÇ MODÜLÜ	TB1-7	KLEMENS GRUBU
IC801	GÜÇ CİHAZI	X52CA,B	RÖLE
L1,L2	REAKTÖR	X65A	RÖLE
LED1-3	LED	X712	RÖLE
LEV A-F	GENLEŞME VANASI SARGISI	X713	RÖLE
MC	KOMPRESÖR	X714	RÖLE
MF	FAN MOTORU	21S2	2 YÖNLÜ VANA SELENOİD SARGISI
PTC1-3	DEVRE KORUMASI	21S4	İKİ YÖNLÜ VANA SELENOİD SARGISI

MXZ-2F53VFHZ - E1

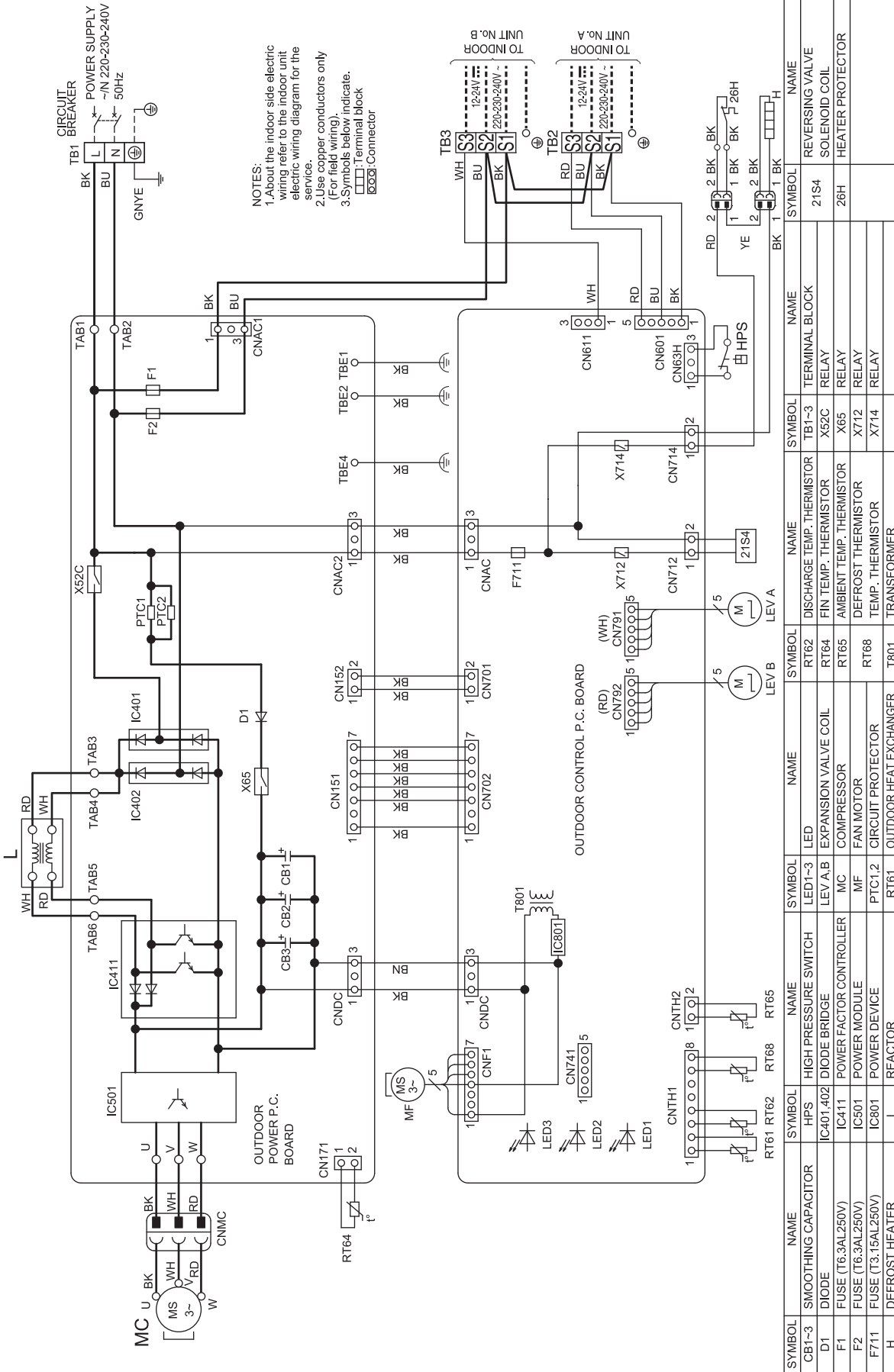

MXZ-4F83VFHZ

E1

POWER SUPPLY
~N 220-230-240V 50Hz

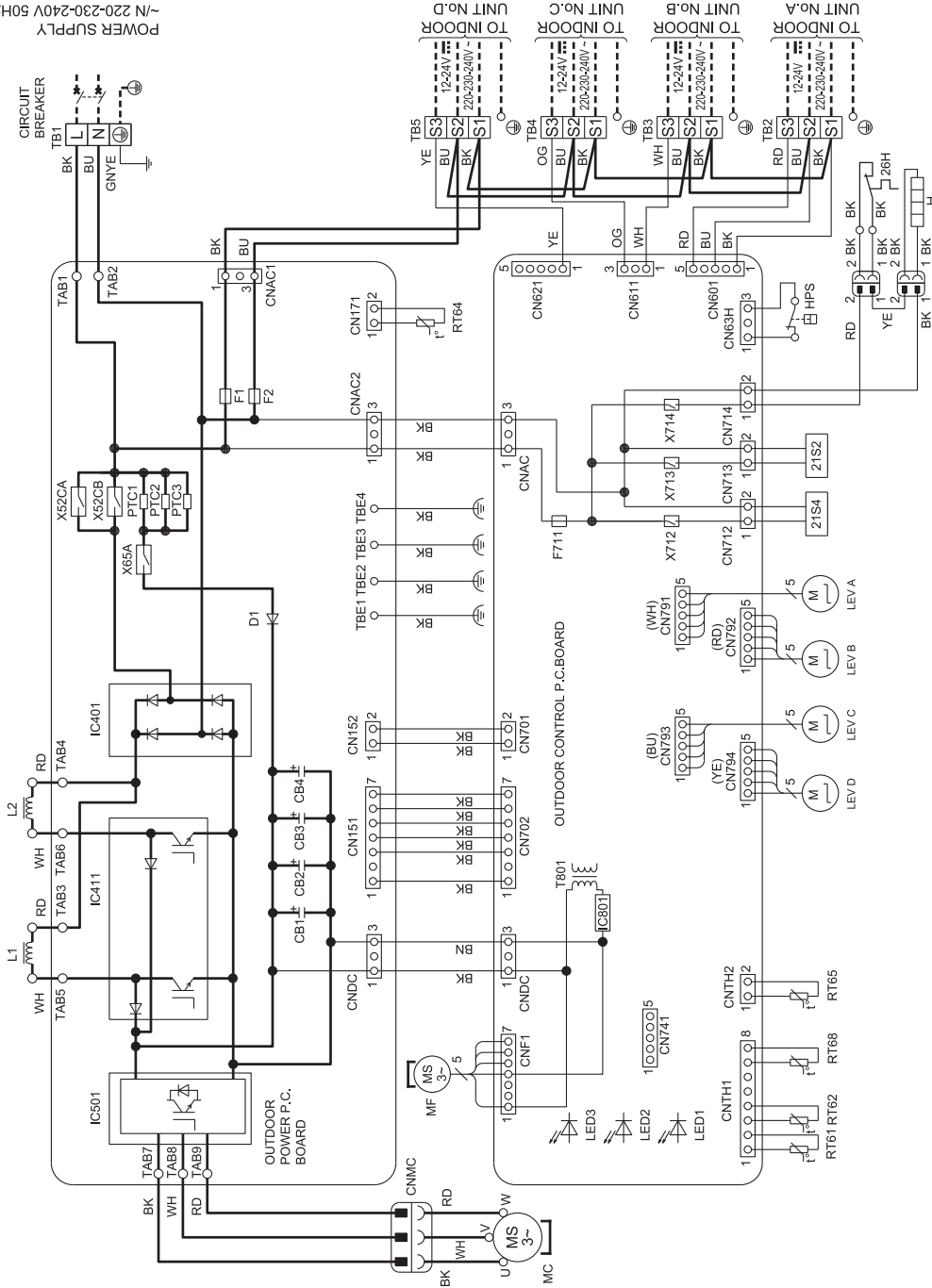

NOTES:
1. About the indoor side electric wiring refer to the indoor unit electric wiring diagram for the service.
2. Use copper conductors only (For field wiring).
3. Symbols below indicate.

SYMBOL	NAME	SYMBOL	NAME
CB1~4	SMOOTHING CAPACITOR	RT61	DEFROST THERMISTOR
D1	DIODE	RT62	DISCHARGE TEMP.THERMISTOR
F1,F2	FUSE(T6.3AL250V)	RT64	FIN TEMP.THERMISTOR
F711	FUSE(T3.15AL250V)	RT65	AMBIENT TEMP.THERMISTOR
H	DEFROST HEATER	RT68	OUTDOOR HEAT EXCHANGER
HPS	HIGH PRESSURE SWITCH		TEMP. THERMISTOR
IC401	DIODE BRIDGE	T801~5	TRANSFORMER
IC501	POWER MODULE	X62CAB	RELAY
IC801	POWER DEVICE	X65A	RELAY
L1,L2	REACTOR	X712	RELAY
LED1~3	LED	X713	RELAY
LEV A-D	EXPANSION VALVE COIL	X714	RELAY
MC	COMPRESSOR	21S2	2WAY VALVE SOLENOID COIL
MF	FAN MOTOR	21S4	REVERSING VALVE SOLENOID COIL
PTCT~3	CIRCUIT PROTECTOR	26H	HEATER PROTECTOR

MXZ-2F33VF
MXZ-2F33VF2
MXZ-2F33VF3

Unit: mm

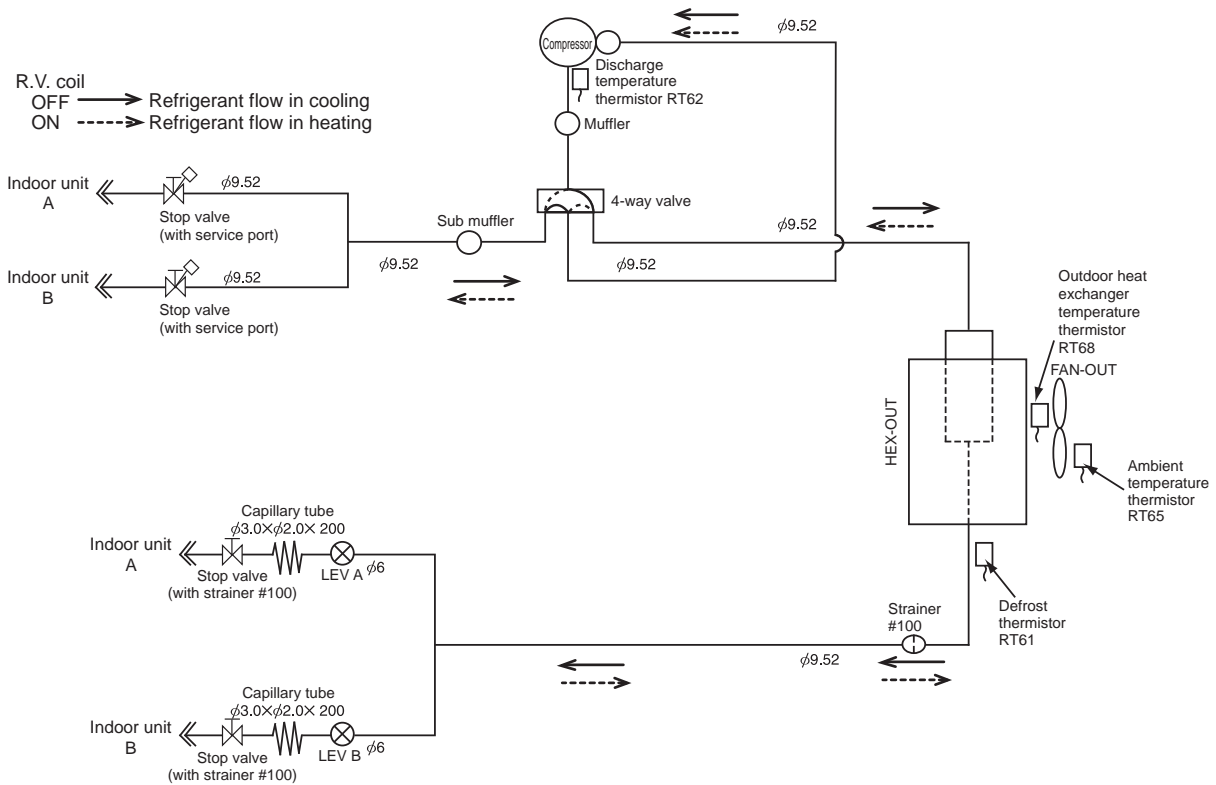

MAX REFRIGERANT PIPING LENGTH

Piping length each indoor unit (a, b)	15 m
Total piping length (a+b)	20 m
Bending point for each unit	15
Total bending point	20

*It is irrelevant which unit is higher.

ADDITIONAL REFRIGERANT CHARGE

Model name	Outdoor unit precharged (g)	Refrigerant piping length (one way, 2 unit total)
		20 m
MXZ-2F33VF MXZ-2F33VF2	1,000	0
MXZ-2F33VF3	800	0

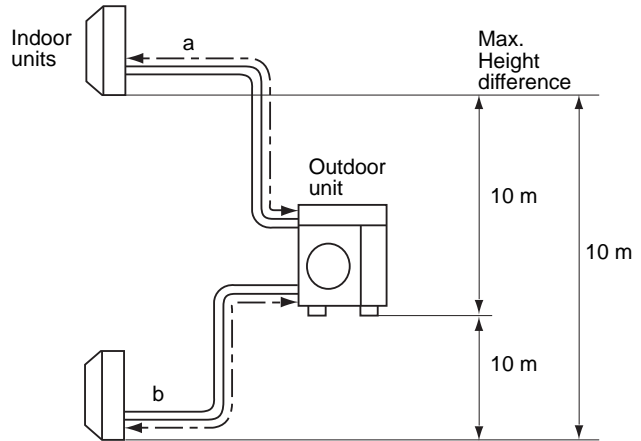

Unit: mm (inch)

- Refrigerant pipe diameter is different according to indoor unit to be connected. When using extension pipes, refer to the right table.

Outdoor unit union diameter		
For		
Indoor unit A	Liquid	6.35(1/4)
	Gas	9.52(3/8)
Indoor unit B	Liquid	6.35(1/4)
	Gas	9.52(3/8)

MXZ-2F42VF MXZ-2F53VF MXZ-2F53VFH
MXZ-2F42VF2 MXZ-2F53VF2 MXZ-2F53VFH2
MXZ-2F42VF3 MXZ-2F53VF3 MXZ-2F53VFH3

Unit: mm

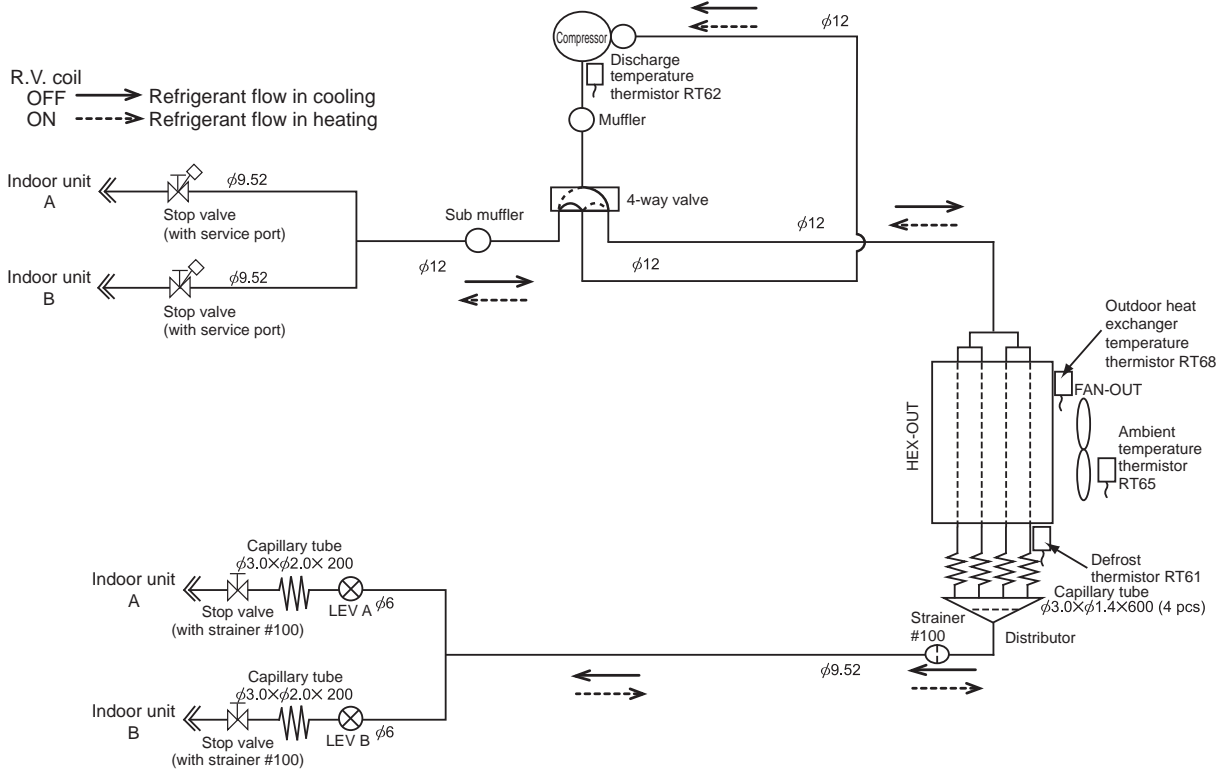

MAX REFRIGERANT PIPING LENGTH

Piping length each indoor unit (a, b)	20 m
Total piping length (a+b)	30 m
Bending point for each unit	30
Total bending point	20

*It is irrelevant which unit is higher.

ADDITIONAL REFRIGERANT CHARGE

Model name	Outdoor unit precharged (g)	Refrigerant piping length (one way, 2 unit total)
		30 m
MXZ-2F42/53VF MXZ-2F53VFH MXZ-2F42/53VF2 MXZ-2F53VFH2	1,200	0
MXZ-2F42/53VF3 MXZ-2F53VFH3	1,000	0

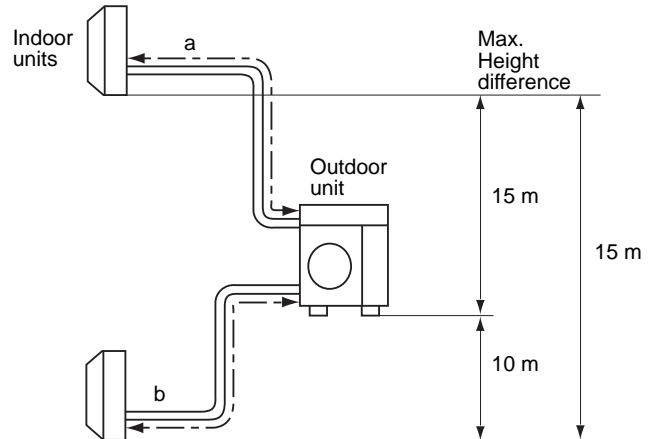

Unit: mm (inch)

Outdoor unit union diameter		
For		
Indoor unit A	Liquid	6.35(1/4)
	Gas	9.52(3/8)
Indoor unit B	Liquid	6.35(1/4)
	Gas	9.52(3/8)

- Refrigerant pipe diameter is different according to indoor unit to be connected. When using extension pipes, refer to the right table.
- For **MXZ-2F53VF**, **MXZ-2F53VF2**, **MXZ-2F53VF3**, **MXZ-2F53VFH**, **MXZ-2F53VFH2** and **MXZ-2F53VFH3** when diameter of refrigerant pipe is different from that of outdoor unit union, use optional Different-diameter pipe. For further information on Different-diameter pipe, refer to "PARTS CATALOG".

MXZ-3F54VF MXZ-3F54VF2 MXZ-3F54VF3

Unit: mm

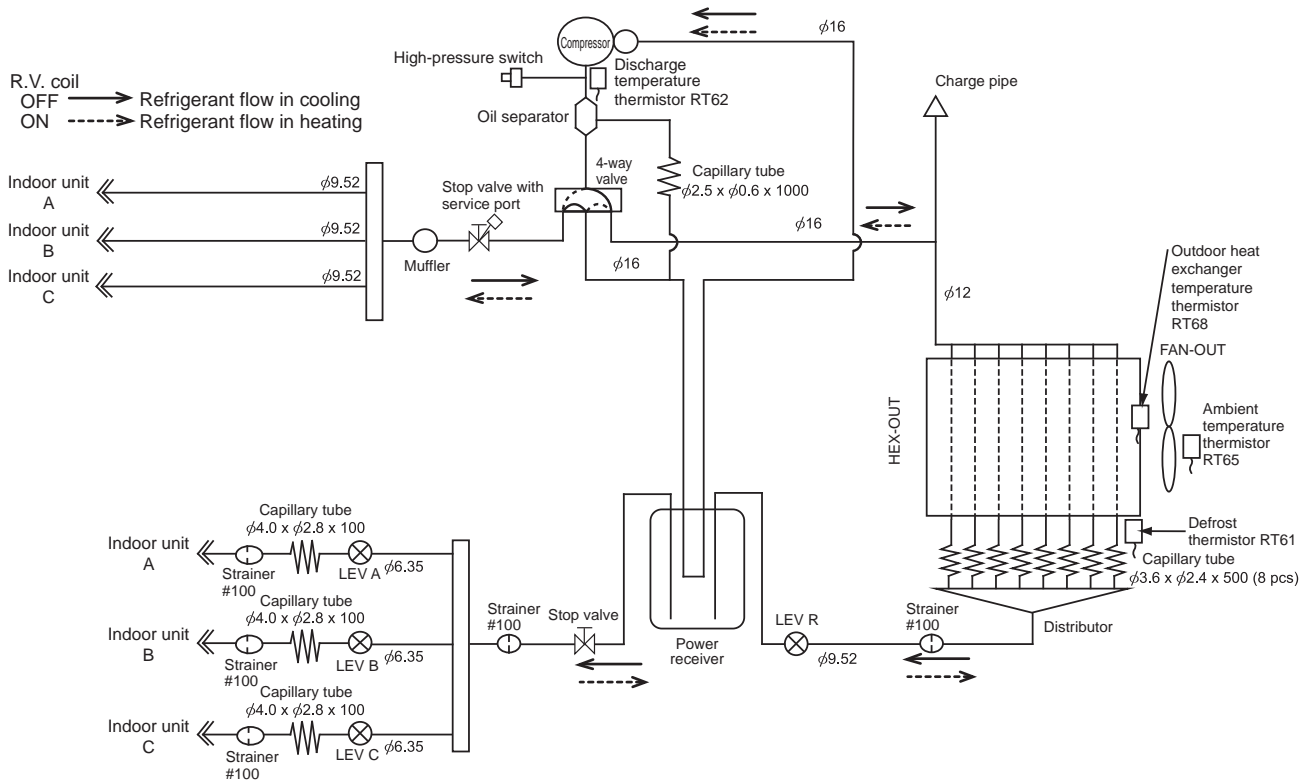

MAX REFRIGERANT PIPING LENGTH

Piping length each indoor unit (a, b, c)	25 m
Total piping length (a+b+c)	50 m
Bending point for each unit	25
Total bending point	50

*It is irrelevant which unit is higher.

ADDITIONAL REFRIGERANT CHARGE

*Refer to "Method of charging refrigerant".

Model name	Outdoor unit precharged (g)	Refrigerant piping length (one way, 3 unit total)
		50 m
MXZ-3F54VF	1,400	0
MXZ-3F54VF2 MXZ-3F54VF3	2,400	0

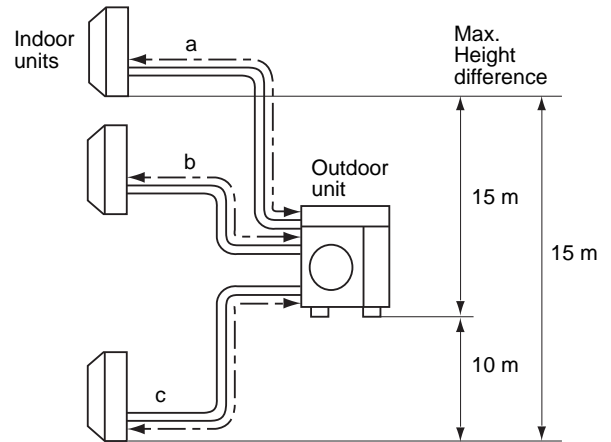

Unit: mm (inch)

Outdoor unit union diameter		
For		
Indoor unit A	Liquid	6.35(1/4)
	Gas	9.52(3/8)
Indoor unit B	Liquid	6.35(1/4)
	Gas	9.52(3/8)
Indoor unit C	Liquid	6.35(1/4)
	Gas	9.52(3/8)

- Refrigerant pipe diameter is different according to indoor unit to be connected. When using extension pipes, refer to the right table.
- When diameter of refrigerant pipe is different from that of outdoor unit union, use optional Different-diameter pipe. For further information on Different-diameter pipe, refer to "PARTS CATALOG".

MXZ-3F68VF MXZ-3F68VF2 MXZ-3F68VF3

Unit: mm

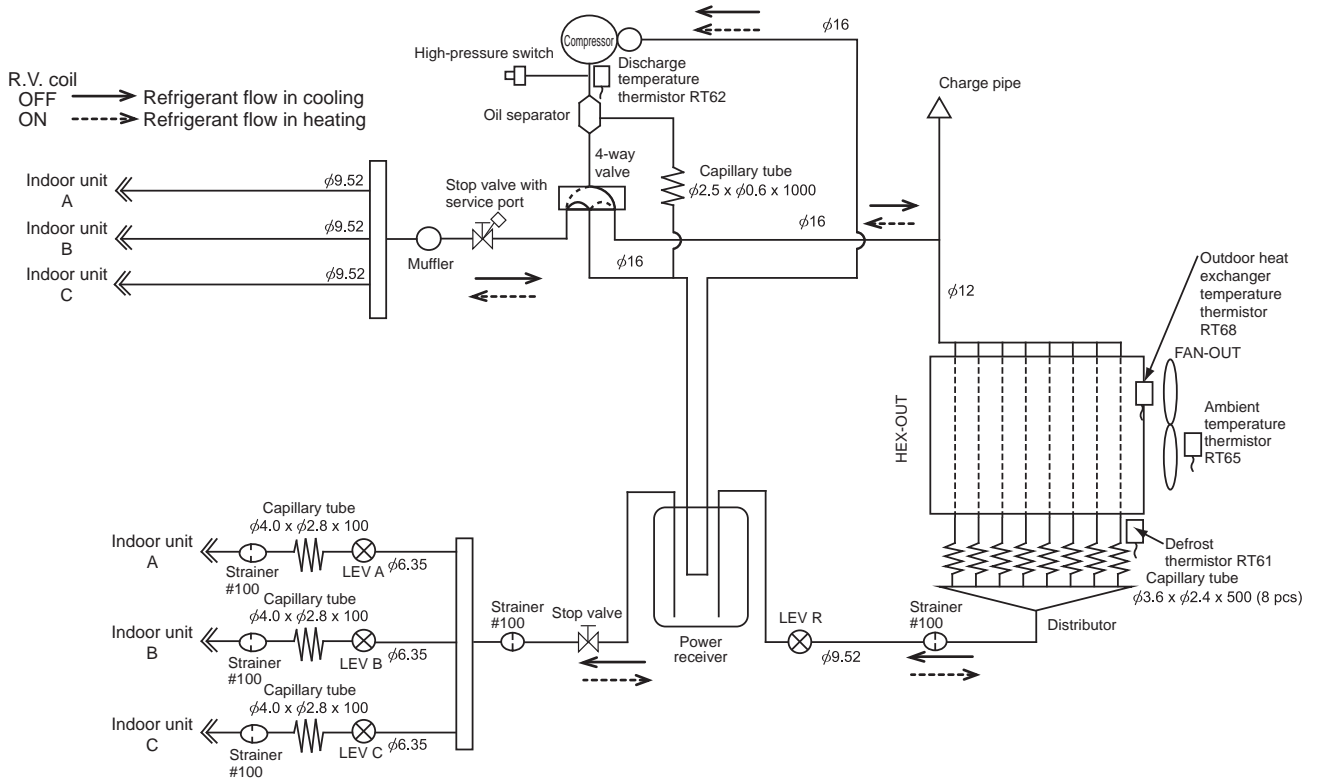

MAX REFRIGERANT PIPING LENGTH

Piping length each indoor unit (a, b, c)	25 m
Total piping length (a+b+c)	60 m
Bending point for each unit	25
Total bending point	60

*It is irrelevant which unit is higher.

ADDITIONAL REFRIGERANT CHARGE

*Refer to "Method of charging refrigerant".

Model name	Outdoor unit precharged (g)	Refrigerant piping length (one way, 3 unit total)
		60 m
MXZ-3F68VF	1,400	0
MXZ-3F68VF2 MXZ-3F68VF3	2,400	0

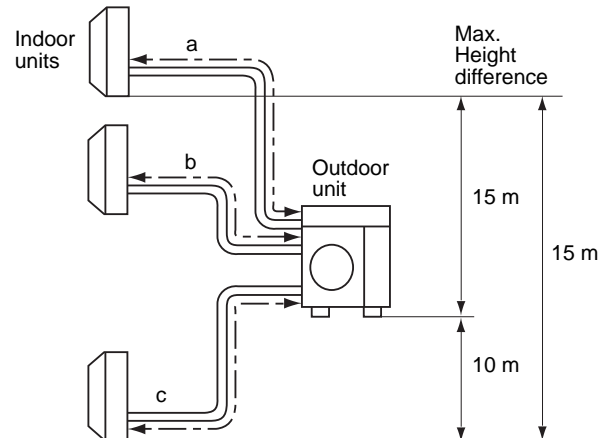

Unit: mm (inch)

- Refrigerant pipe diameter is different according to indoor unit to be connected. When using extension pipes, refer to the right table.
- When diameter of refrigerant pipe is different from that of outdoor unit union, use optional Different-diameter pipe. For further information on Different-diameter pipe, refer to "PARTS CATALOG".

Outdoor unit union diameter		
For		
Indoor unit A	Liquid	6.35(1/4)
	Gas	9.52(3/8)
Indoor unit B	Liquid	6.35(1/4)
	Gas	9.52(3/8)
Indoor unit C	Liquid	6.35(1/4)
	Gas	9.52(3/8)

MXZ-4F72VF

**MXZ-4F72VF2
MXZ-4F80VF2**

**MXZ-4F72VF3
MXZ-4F80VF3**

Unit: mm

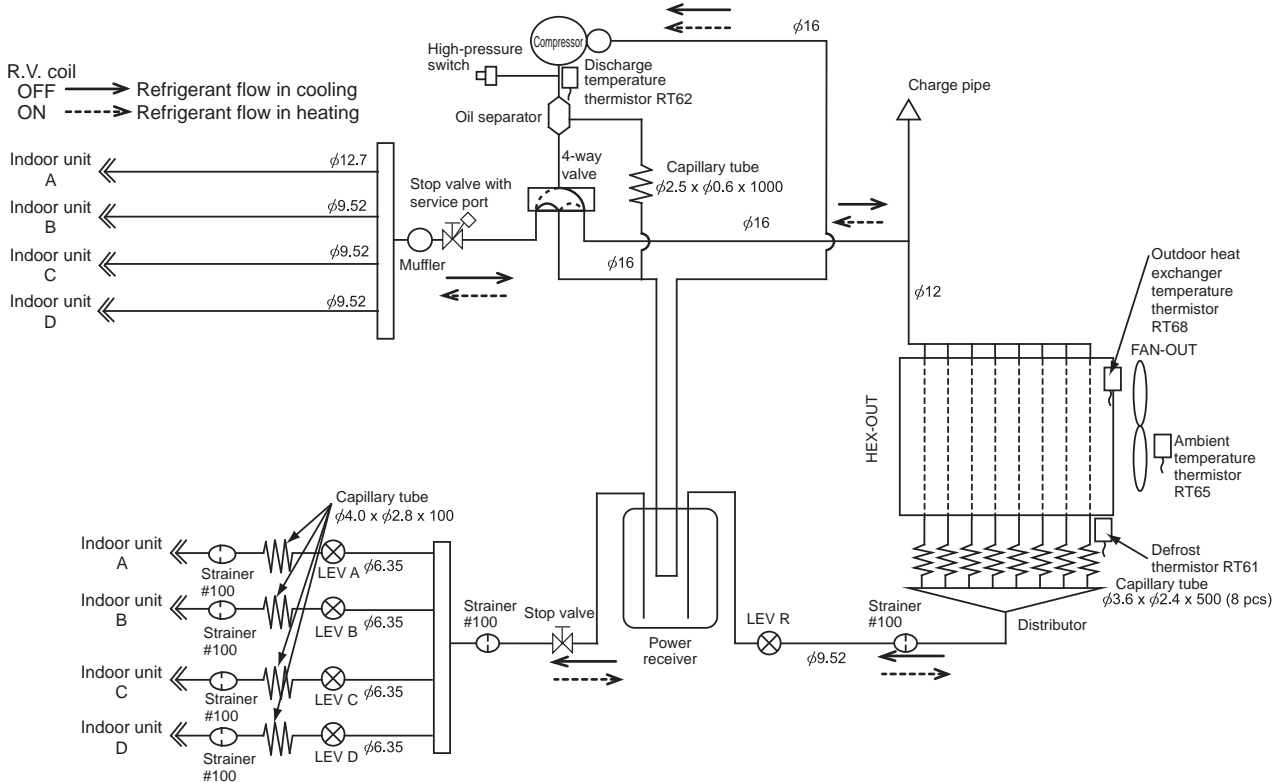

MAX REFRIGERANT PIPING LENGTH

Piping length each indoor unit (a, b, c, d)	25 m
Total piping length (a+b+c+d)	60 m
Bending point for each unit	25
Total bending point	60

*It is irrelevant which unit is higher.

ADDITIONAL REFRIGERANT CHARGE

*Refer to "Method of charging refrigerant".

Model name	Outdoor unit precharged (g)	Refrigerant piping length (one way, 4 unit total)
MXZ-4F72VF	1,400	0
MXZ-4F72VF2 MXZ-4F72VF3 MXZ-4F80VF2 MXZ-4F80VF3	2,400	0

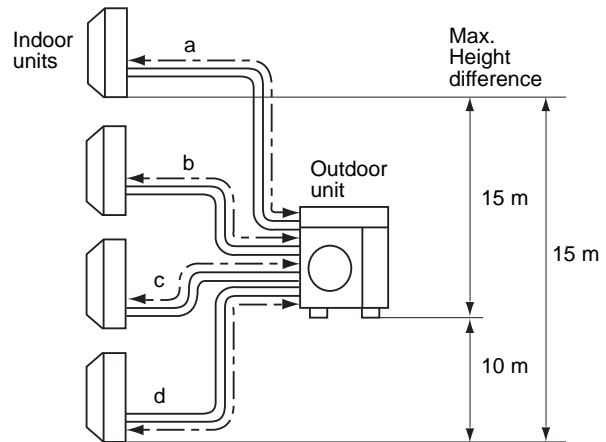

Unit: mm (inch)

- Refrigerant pipe diameter is different according to indoor unit to be connected. When using extension pipes, refer to the right table.
- When diameter of refrigerant pipe is different from that of outdoor unit union, use optional Different-diameter pipe. For further information on Different-diameter pipe, refer to "PARTS CATALOG".

Outdoor unit union diameter		
For		
Indoor unit A	Liquid	6.35(1/4)
	Gas	12.7(1/2)
Indoor unit B	Liquid	6.35(1/4)
	Gas	9.52(3/8)
Indoor unit C	Liquid	6.35(1/4)
	Gas	9.52(3/8)
Indoor unit D	Liquid	6.35(1/4)
	Gas	9.52(3/8)

MXZ-4F83VF

UNIT: mm

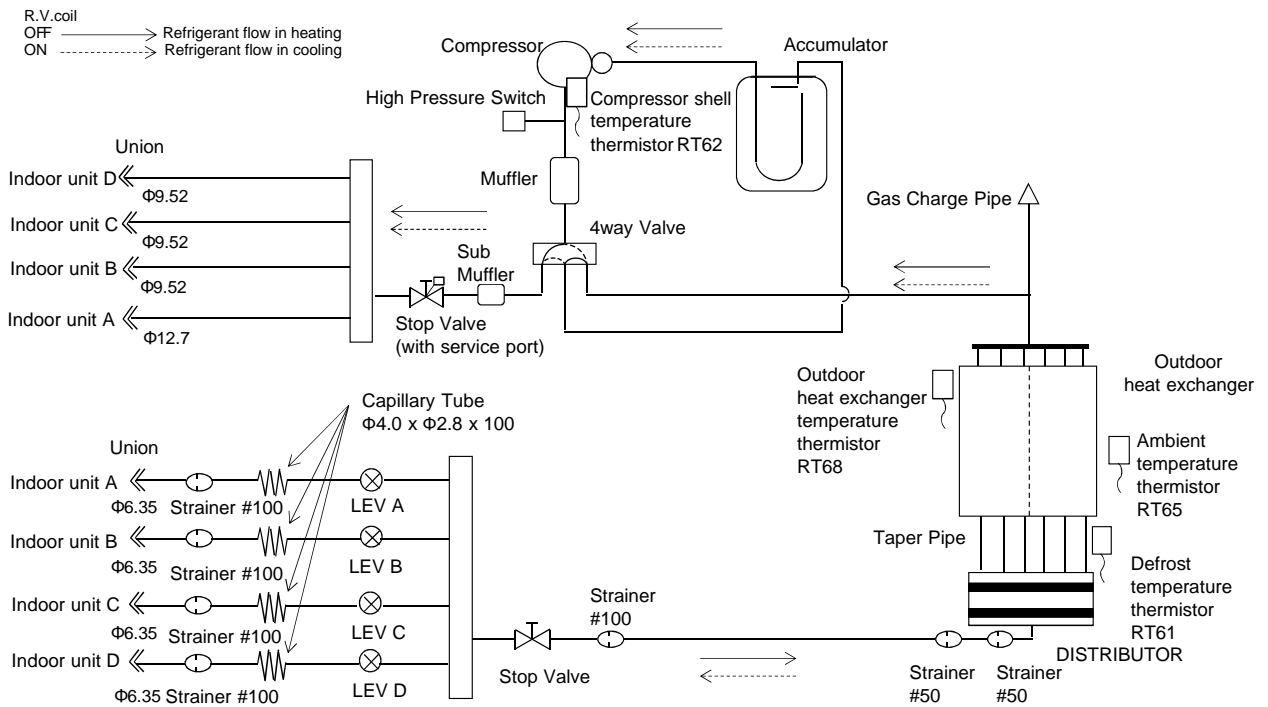

MAX REFRIGERANT PIPING LENGTH

Piping length each indoor unit (a, b, c, d)	25 m
Total piping length (a+b+c+d)	70 m
Bending point for each unit	25
Total bending point	70

*It is irrelevant which unit is higher.

ADDITIONAL REFRIGERANT CHARGE

Outdoor unit precharged (g)	Refrigerant piping length (one way, 4 units total)	
		70 m
2,400	0	

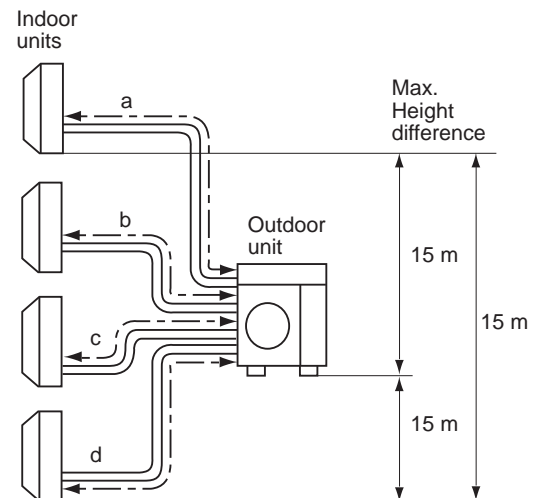

- Refrigerant pipe diameter is different according to indoor unit to be connected. When using extension pipes, refer to the tables below.
- When diameter of refrigerant pipe is different from that of outdoor unit union, use optional Different-diameter pipe. For further information on Different-diameter pipe, refer to "PARTS CATALOG".

UNIT: mm (inch)

Outdoor unit union diameter		
For		
Indoor unit A	Liquid	6.35(1/4)
	Gas	12.7(1/2)
Indoor unit B	Liquid	6.35(1/4)
	Gas	9.52(3/8)
Indoor unit C	Liquid	6.35(1/4)
	Gas	9.52(3/8)
Indoor unit D	Liquid	6.35(1/4)
	Gas	9.52(3/8)

MXZ-5F102VF

UNIT: mm

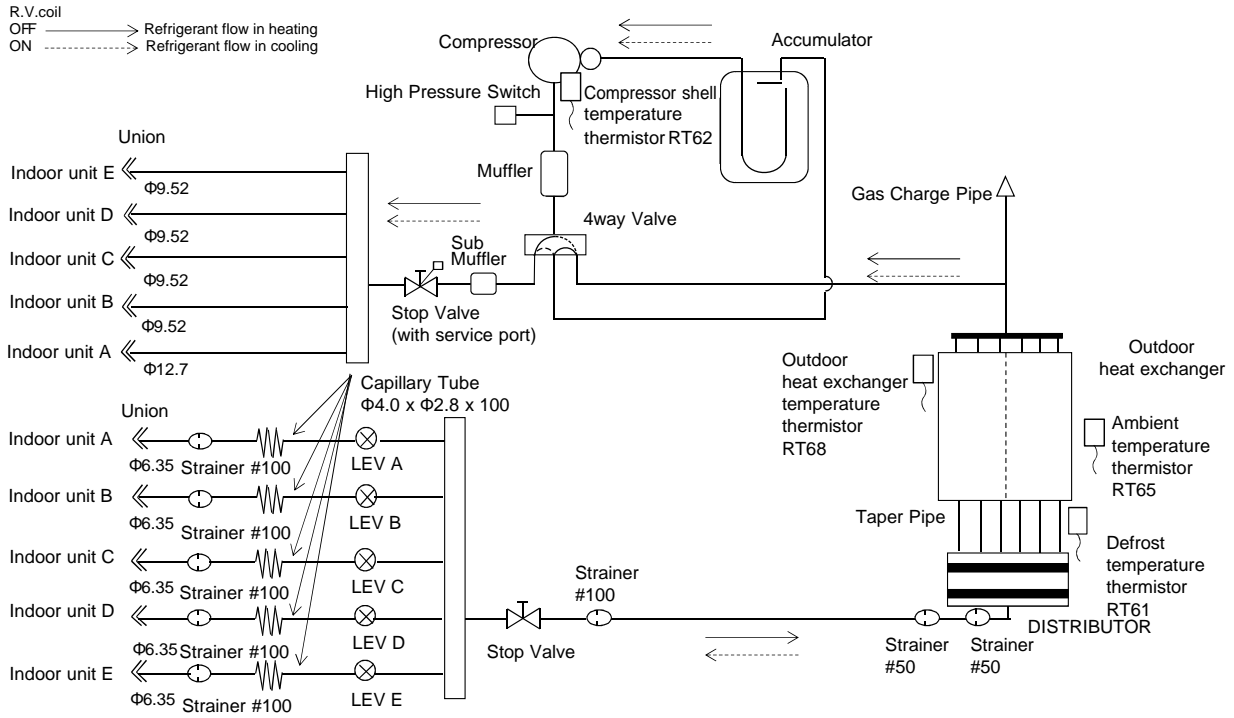

MAX REFRIGERANT PIPING LENGTH

Piping length each indoor unit (a, b, c, d, e)	25 m
Total piping length (a+b+c+d+e)	80 m
Bending point for each unit	25
Total bending point	80

*It is irrelevant which unit is higher.

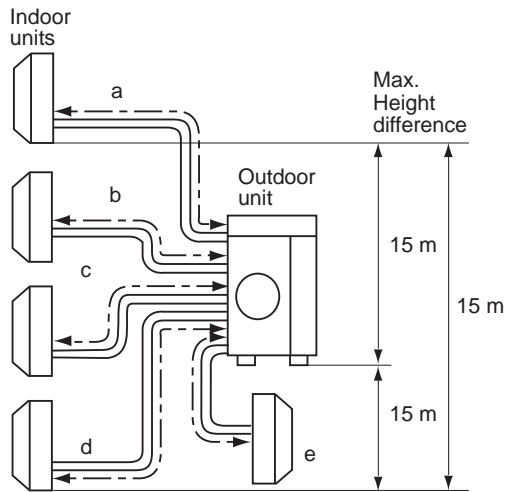

ADDITIONAL REFRIGERANT CHARGE

Outdoor unit precharged (g)	Refrigerant piping length (one way, 5 units total)	
	80 m	0
2,400		

- Refrigerant pipe diameter is different according to indoor unit to be connected. When using extension pipes, refer to the tables below.
- When diameter of refrigerant pipe is different from that of outdoor unit union, use optional Different-diameter pipe. For further information on Different-diameter pipe, refer to "PARTS CATALOG".

UNIT: mm (inch)

Outdoor unit union diameter		
For		
Indoor unit A	Liquid	6.35(1/4)
	Gas	12.7(1/2)
Indoor unit B	Liquid	6.35(1/4)
	Gas	9.52(3/8)
Indoor unit C	Liquid	6.35(1/4)
	Gas	9.52(3/8)
Indoor unit D	Liquid	6.35(1/4)
	Gas	9.52(3/8)
Indoor unit E	Liquid	6.35(1/4)
	Gas	9.52(3/8)

MXZ-6F122VF

UNIT: mm

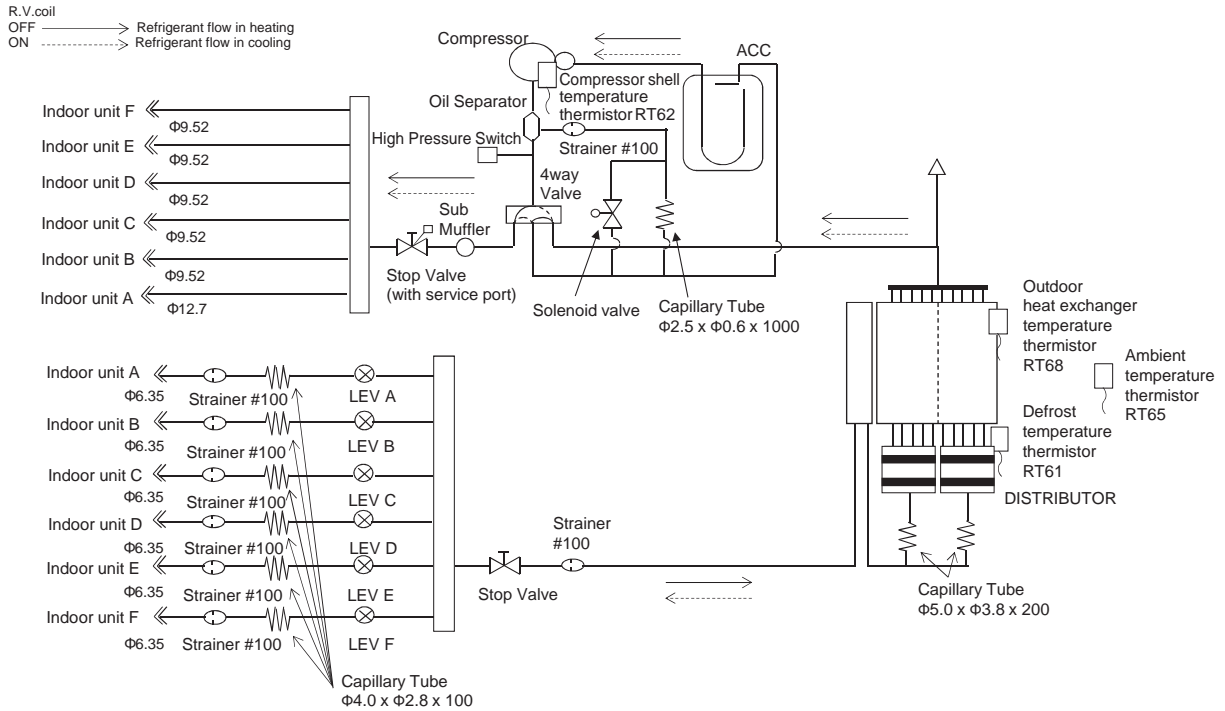

MAX REFRIGERANT PIPING LENGTH

Piping length each indoor unit (a, b, c, d, e, f)	25 m
Total piping length (a+b+c+d+e+f)	80 m
Bending point for each unit	25
Total bending point	80

*It is irrelevant which unit is higher.

ADDITIONAL REFRIGERANT CHARGE

Outdoor unit precharged (g)	Refrigerant piping length (one way, 6 units total)	
	80 m	0
2,400		

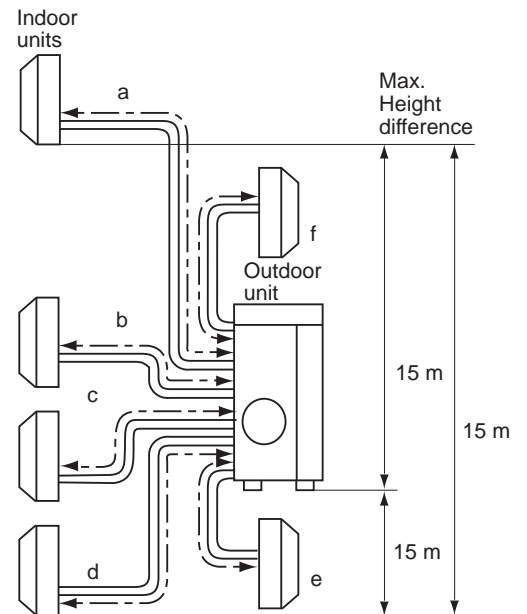

- Refrigerant pipe diameter is different according to indoor unit to be connected. When using extension pipes, refer to the tables below.
- When diameter of refrigerant pipe is different from that of outdoor unit union, use optional Different-diameter pipe. For further information on Different-diameter pipe, refer to "PARTS CATALOG".

UNIT: mm (inch)

Outdoor unit union diameter			Outdoor unit union diameter		
For			For		
Indoor unit A	Liquid	6.35(1/4)	Indoor unit D	Liquid	6.35(1/4)
	Gas	12.7(1/2)		Gas	9.52(3/8)
Indoor unit B	Liquid	6.35(1/4)	Indoor unit E	Liquid	6.35(1/4)
	Gas	9.52(3/8)		Gas	9.52(3/8)
Indoor unit C	Liquid	6.35(1/4)	Indoor unit F	Liquid	6.35(1/4)
	Gas	9.52(3/8)		Gas	9.52(3/8)

MXZ-2F53VFHZ

UNIT: mm

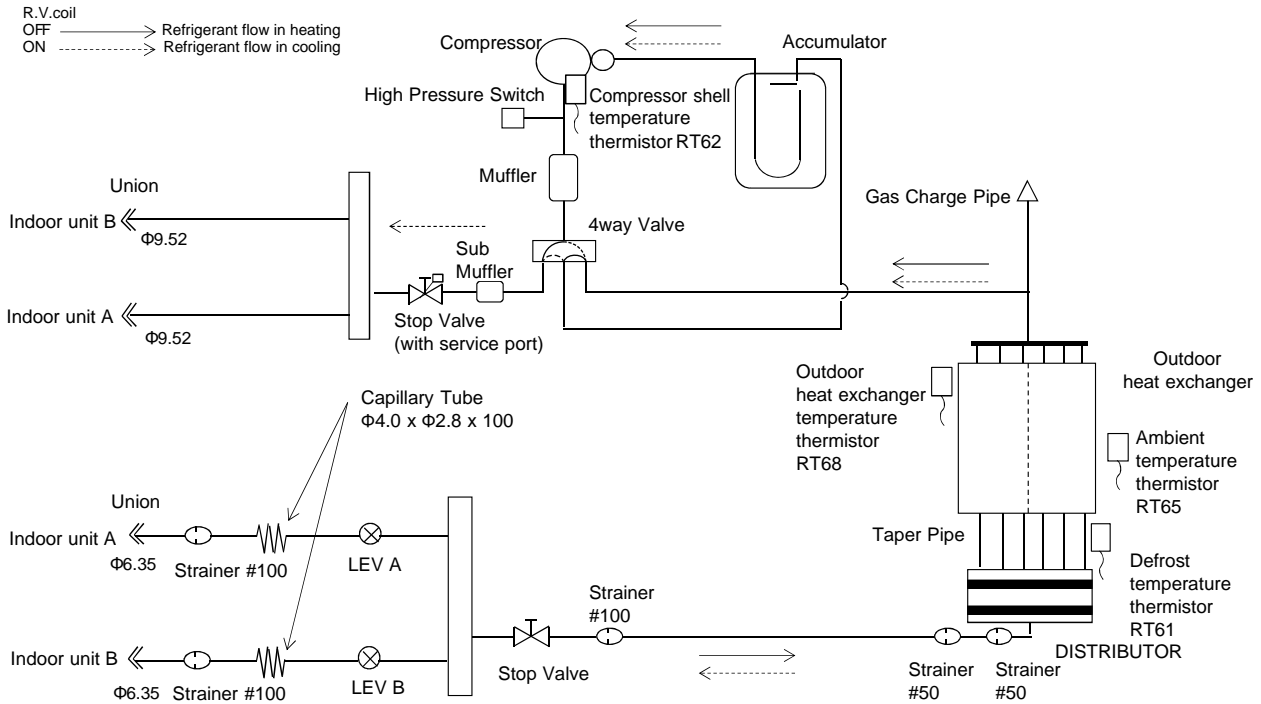

MAX REFRIGERANT PIPING LENGTH

Piping length each indoor unit (a, b)	20 m
Total piping length (a+b)	30 m
Bending point for each unit	20
Total bending point	30

*It is irrelevant which unit is higher.

ADDITIONAL REFRIGERANT CHARGE

Outdoor unit precharged (g)	Refrigerant piping length (one way, 2 units total)	
		30 m
2,400		0

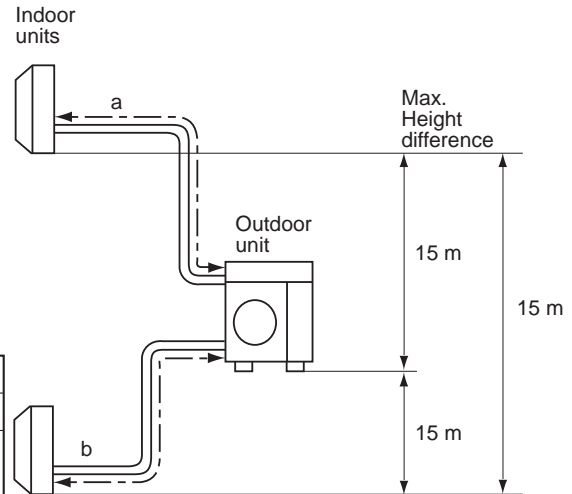

- Refrigerant pipe diameter is different according to indoor unit to be connected. When using extension pipes, refer to the tables below.
- When diameter of refrigerant pipe is different from that of outdoor unit union, use optional Different-diameter pipe. For further information on Different-diameter pipe, refer to "PARTS CATALOG".

UNIT: mm (inch)

Outdoor unit union diameter		
For		
Indoor unit A	Liquid	6.35(1/4)
	Gas	9.52(3/8)
Indoor unit B	Liquid	6.35(1/4)
	Gas	9.52(3/8)

MXZ-4F83VFHZ

UNIT: mm

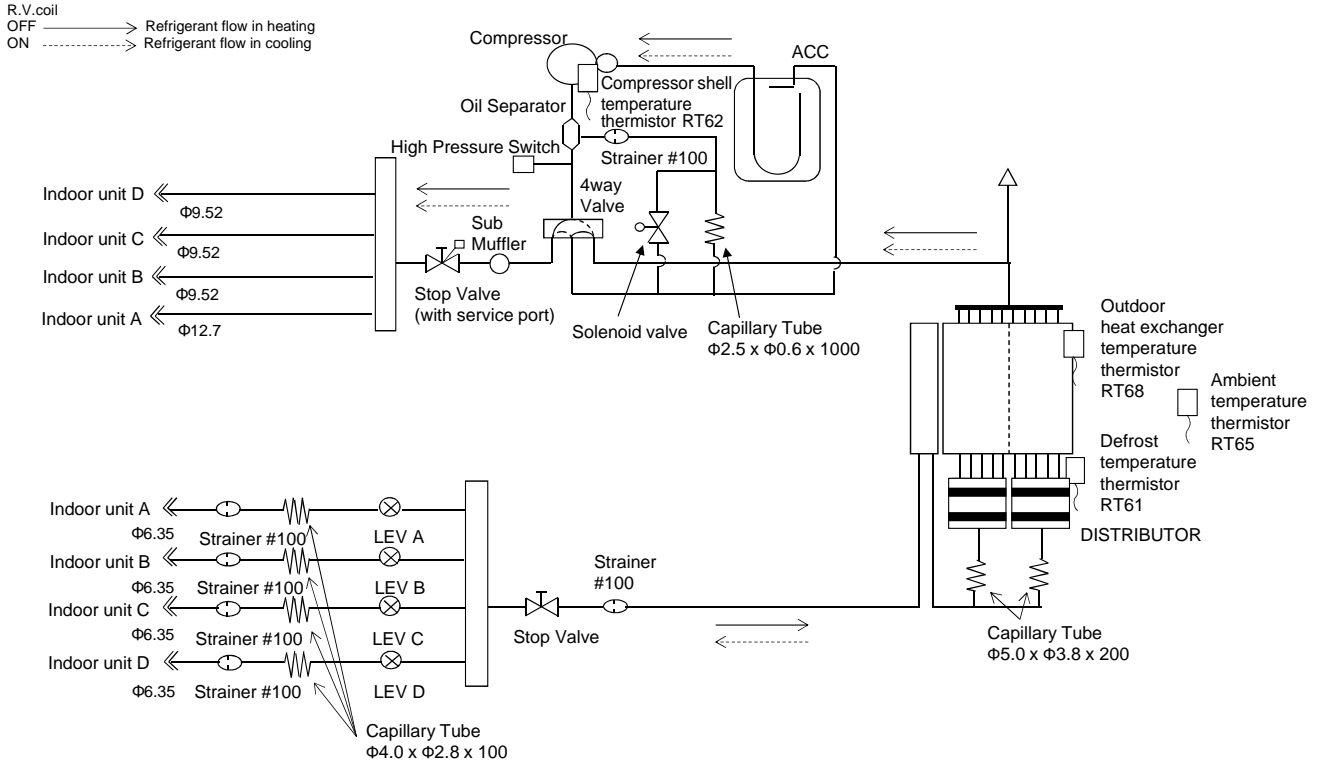

MAX REFRIGERANT PIPING LENGTH

Piping length each indoor unit (a, b, c, d)	25 m
Total piping length (a+b+c+d)	70 m
Bending point for each unit	25
Total bending point	70

*It is irrelevant which unit is higher.

ADDITIONAL REFRIGERANT CHARGE

Outdoor unit precharged (g)	Refrigerant piping length (one way, 4 units total)	
	70 m	0
2,400		

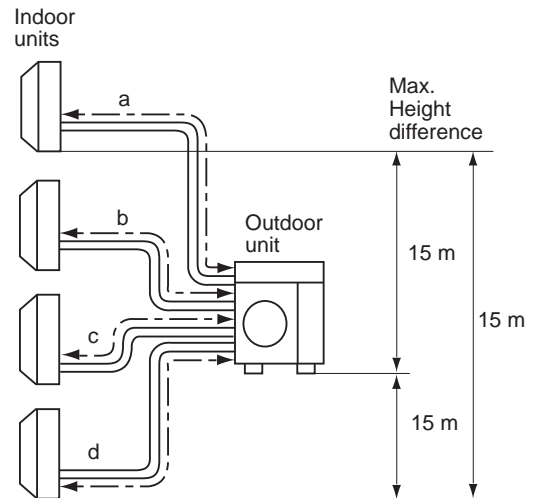

- Refrigerant pipe diameter is different according to indoor unit to be connected. When using extension pipes, refer to the tables below.
- When diameter of refrigerant pipe is different from that of outdoor unit union, use optional Different-diameter pipe. For further information on Different-diameter pipe, refer to "PARTS CATALOG".

UNIT: mm (inch)

Outdoor unit union diameter		
For		
Indoor unit A	Liquid	6.35(1/4)
	Gas	12.7(1/2)
Indoor unit B	Liquid	6.35(1/4)
	Gas	9.52(3/8)
Indoor unit C	Liquid	6.35(1/4)
	Gas	9.52(3/8)
Indoor unit D	Liquid	6.35(1/4)
	Gas	9.52(3/8)

Method of Charging refrigerant

■MXZ-3F54VF/3F68VF/4F72VF

Total refrigerant *3	=	Pre charge	+	Indoor unit number *1	+	Connection of specific I/U *2	+	Piping length
..... kg		1.4 kg	 kg	 kg		0.0 kg

■MXZ-3F54VF2/3F68VF2/4F72VF2/4F80VF2

Total refrigerant	=	Pre charge	+		+	Piping length
2.4 kg		2.4 kg				0.0 kg

■MXZ-2F42VF/2F53VF/2F53VFH

■MXZ-2F42VF2/2F53VF2/2F53VFH2

Total refrigerant	=	Pre charge	+		+	Piping length
1.2 kg		1.2 kg				0.0 kg

■MXZ-2F42VF3/2F53VF3/2F53VFH3

Total refrigerant	=	Pre charge	+		+	Piping length
1.0 kg		1.0 kg				0.0 kg

■MXZ-2F33VF

■MXZ-2F33VF2

Total refrigerant	=	Pre charge	+		+	Piping length
1.0 kg		1.0 kg				0.0 kg

■MXZ-2F33VF3

Total refrigerant	=	Pre charge	+		+	Piping length
0.8 kg		0.8 kg				0.0 kg

*1 If you connect indoor unit number 3 or 4 units, please add to charge refrigerant amount **0.5kg**

*2 If you connect specific indoor unit(s), please add to charge refrigerant amount **0.17kg per 1unit**

Specific indoor unit is following: MSZ-LN18/25/35VG MLZ-KP25/35/50VF

SEZ-M50DA(L) PCA-M50/60KA

PEAD-M50JA(L)

*3 In case total refrigerant amount exceed **2.4kg** depending on combination, please charge only **1.0kg** for maximum.

PUMPING DOWN

When relocating or disposing of the air conditioner, pump down the system following the procedure below so that no refrigerant is released into the atmosphere.

- 1) Turn off the breaker.
 - 2) Connect the gauge manifold valve to the service port of the stop valve on the gas pipe side of the outdoor unit.
 - 3) Fully close the stop valve on the liquid pipe side of the outdoor unit.
 - 4) Turn on the breaker.
 - 5) Start the emergency COOL operation on all the indoor units.
 - 6) When the pressure gauge shows 0.05 to 0 MPa [Gauge] (approximately 0.5 to 0 kgf/cm²), fully close the stop valve on the gas pipe side of the outdoor unit and stop the operation. (Refer to the indoor unit installation manual about the method for stopping the operation.)
- * If too much refrigerant has been added to the air conditioner system, the pressure may not drop to 0.05 to 0 MPa [Gauge] (approximately 0.5 to 0 kgf/cm²), or the protection function may operate due to the pressure increase in the high pressure refrigerant circuit. If this occurs, use a refrigerant collecting device to collect all of the refrigerant in the system, and then recharge the system with the correct amount of refrigerant after the indoor and outdoor units have been relocated.
- 7) Turn off the breaker. Remove the pressure gauge and the refrigerant piping.

WARNING

When pumping down the refrigerant, stop the compressor before disconnecting the refrigerant pipes. The compressor may burst and cause injury if any foreign substance, such as air, enters the pipes.

MXZ-2F33VF	MXZ-2F42VF	MXZ-2F53VF	MXZ-2F53VFH
MXZ-2F33VF2	MXZ-2F42VF2	MXZ-2F53VF2	MXZ-2F53VFH2
MXZ-2F33VF3	MXZ-2F42VF3	MXZ-2F53VF3	MXZ-2F53VFH3
MXZ-3F54VF	MXZ-3F68VF	MXZ-4F72VF	
MXZ-3F54VF2	MXZ-3F68VF2	MXZ-4F72VF2	MXZ-4F80VF2
MXZ-3F54VF3	MXZ-3F68VF3	MXZ-4F72VF3	MXZ-4F80VF3
MXZ-4F83VF	MXZ-5F102VF	MXZ-6F122VF	
MXZ-2F53VFHZ	MXZ-4F83VFHZ		

The standard specifications apply only to the operation of the air conditioner under normal conditions. Since operating conditions vary according to the areas where these units are installed, the following information has been provided to clarify the operating characteristics of the air conditioner under the conditions indicated by the performance curve.

(1) GUARANTEED VOLTAGE

198 - 264 V 50 Hz

(2) AIR FLOW

Air flow should be set at MAX.

(3) MAIN READINGS

(1) Indoor intake air wet-bulb temperature:	°CWB	} Cooling
(2) Indoor outlet air wet-bulb temperature:	°CWB	
(3) Outdoor intake air dry-bulb temperature:	°CDB	
(4) Total input:	W	} Heating
(5) Indoor intake air dry-bulb temperature:	°CDB	
(6) Outdoor intake air wet-bulb temperature:	°CWB	
(7) Total input:	W	

Indoor air wet and dry bulb temperature difference on the left side of the following chart shows the difference between the indoor intake air wet and dry bulb temperature and the indoor outlet air wet and dry bulb temperature for your reference at service.

How to measure the indoor air wet and dry bulb temperature difference

- Attach at least 2 sets of wet and dry bulb thermometers to the indoor air intake as shown in the figure, and at least 2 sets of wet and dry bulb thermometers to the indoor air outlet. The thermometers must be attached to the position where air speed is high.
- Attach at least 2 sets of wet and dry bulb thermometers to the outdoor air intake. Cover the thermometers to prevent direct rays of the sun.
- Check that the air filter is cleaned.
- Open windows and doors of room.
- Press the EMERGENCY OPERATION switch once (twice) to start the EMERGENCY COOL (HEAT) MODE.
- When system stabilizes after more than 15 minutes, measure temperature and take an average temperature.
- 10 minutes later, measure temperature again and check that the temperature does not change.

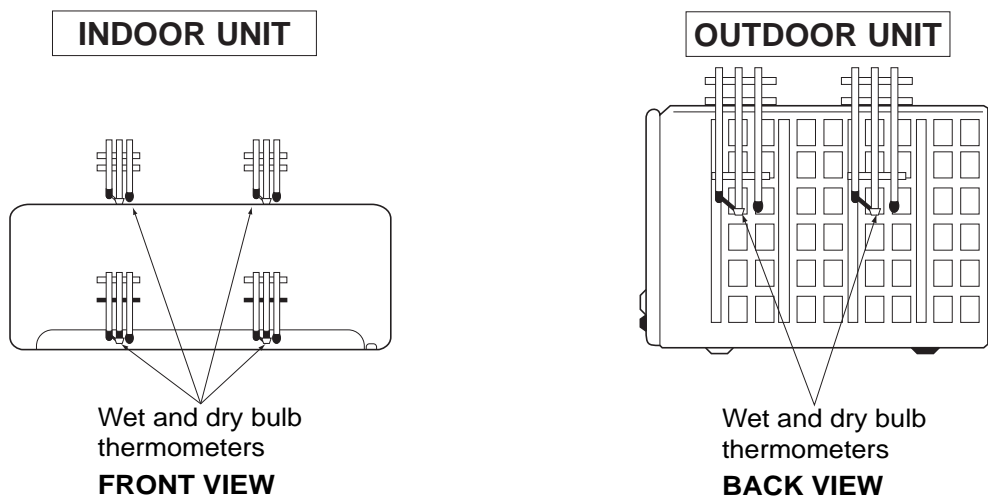

9-1. CAPACITY AND THE INPUT CURVES

MXZ-2F33VF MXZ-2F42VF MXZ-2F53VF MXZ-2F53VFH
 MXZ-2F33VF2 MXZ-2F42VF2 MXZ-2F53VF2 MXZ-2F53VFH2
 MXZ-2F33VF3 MXZ-2F42VF3 MXZ-2F53VF3 MXZ-2F53VFH3

5.8	4.1	7.4	5.2	5.9	8.7	11.1	12.8
5.4	3.8	6.8	4.8	5.5	8.0	10.2	11.6
4.9	3.5	6.2	4.4	5.0	7.3	9.3	10.5
4.5	3.2	5.7	4.0	4.6	6.6	8.3	9.5
4.0	2.9	5.1	3.6	4.1	5.9	7.5	8.5
3.6	2.6	4.5	3.2	3.7	5.3	6.6	7.5
3.2	2.3	4.0	2.8	3.2	4.6	5.8	6.6
2.8	2.0	3.5	2.4	2.8	4.0	5.0	5.6
15 class	18 class	20 class	22 class	25 class	35 class (MXZ-2F42/53)	42 class (MXZ-2F53)	50 class (MXZ-2F53)

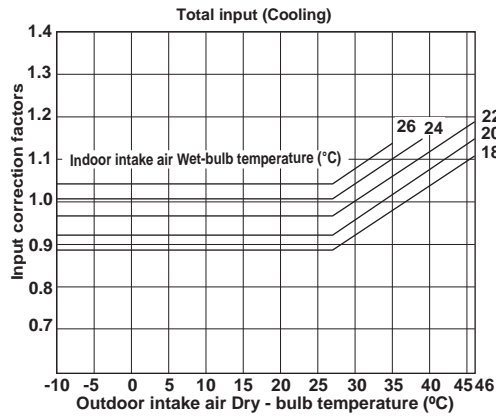
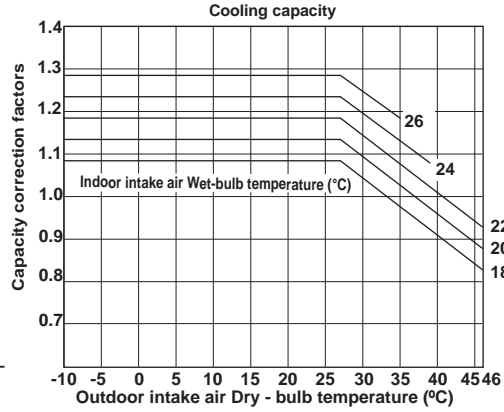

17.6	19.5	21.2	19.5	21.3	22.2	26.6	26.7
16.3	18.1	19.7	18.1	19.8	20.6	24.7	24.8
15.1	16.7	18.2	16.7	18.3	19.0	22.8	22.9
13.8	15.3	16.7	15.3	16.7	17.4	20.9	21.0
12.6	13.9	15.2	13.9	15.2	15.8	19.0	19.1
11.3	12.6	13.6	12.6	13.7	14.3	17.1	17.1
10.1	11.2	12.1	11.2	12.2	12.7	15.2	15.2
8.8	9.8	10.6	9.8	10.7	11.1	13.3	13.3
7.5	8.4	9.1	8.4	9.1	9.5	11.4	11.4
6.3	7.0	7.6	7.0	7.6	7.9	9.5	9.5
5.0	5.6	6.1	5.6	6.1	6.3	7.6	7.6
15 class	18 class	20 class	22 class	25 class	35 class (MXZ-2F42/53)	42 class (MXZ-2F53)	50 class (MXZ-2F53)

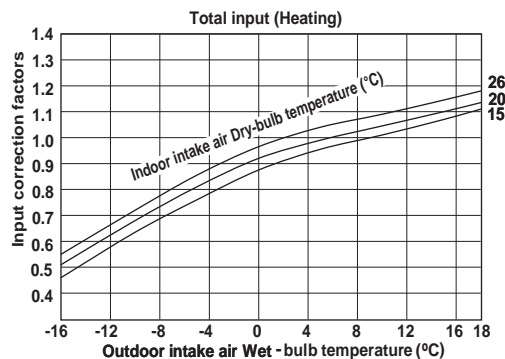
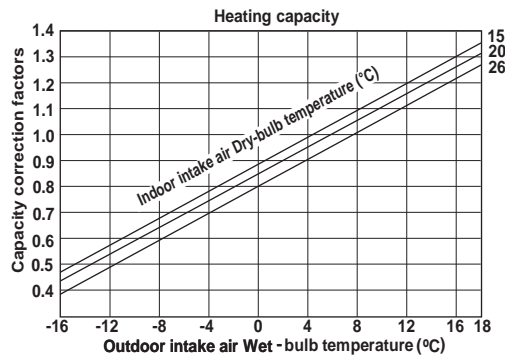

MXZ-3F54VF MXZ-3F68VF MXZ-4F72VF
MXZ-3F54VF2 MXZ-3F68VF2 MXZ-4F72VF2 MXZ-4F80VF2
MXZ-3F54VF3 MXZ-3F68VF3 MXZ-4F72VF3 MXZ-4F80VF3

5.8	4.1	7.4	5.2	5.9	8.7	11.1	12.8	8.7
5.4	3.8	6.8	4.8	5.5	8.0	10.2	11.6	8.0
4.9	3.5	6.2	4.4	5.0	7.3	9.3	10.5	7.3
4.5	3.2	5.7	4.0	4.6	6.6	8.3	9.5	6.6
4.0	2.9	5.1	3.6	4.1	5.9	7.5	8.5	5.9
3.6	2.6	4.5	3.2	3.7	5.3	6.6	7.5	5.3
3.2	2.3	4.0	2.8	3.2	4.6	5.8	6.6	4.6
2.8	2.0	3.5	2.4	2.8	4.0	5.0	5.6	4.0
15 class	18 class	20 class	22 class	25 class	35 class	42 class	50 class	60 class

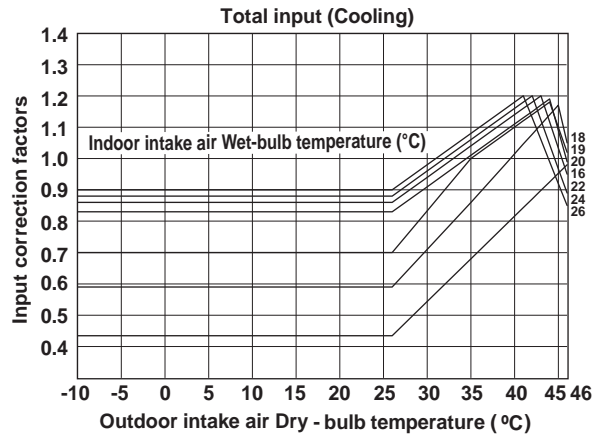
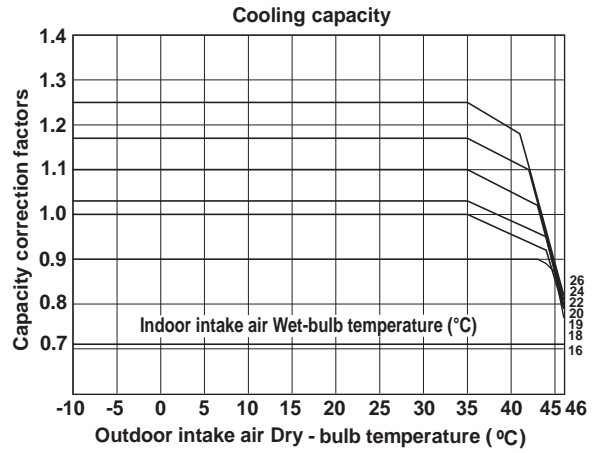

17.6	19.5	21.2	19.5	21.3	22.2	29.9	38.4	30.9
16.3	18.1	19.7	18.1	19.8	20.6	27.8	35.7	28.7
15.1	16.7	18.2	16.7	18.3	19.0	25.7	32.9	26.5
13.8	15.3	16.7	15.3	16.7	17.4	23.5	30.2	24.3
12.6	13.9	15.2	13.9	15.2	15.8	21.4	27.4	22.1
11.3	12.6	13.6	12.6	13.7	14.3	19.2	24.7	19.9
10.1	11.2	12.1	11.2	12.2	12.7	17.1	21.9	17.7
8.8	9.8	10.6	9.8	10.7	11.1	15.0	19.2	15.5
7.5	8.4	9.1	8.4	9.1	9.5	12.8	16.5	13.2
6.3	7.0	7.6	7.0	7.6	7.9	10.7	13.7	11.0
5.0	5.6	6.1	5.6	6.1	6.3	8.6	11.0	8.8
15 class	18 class	20 class	22 class	25 class	35 class	42 class	50 class	60 class

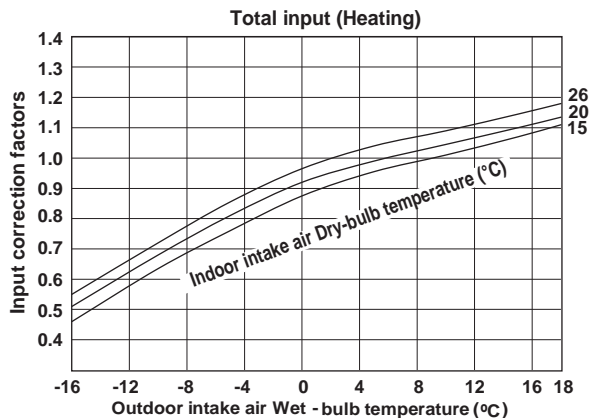
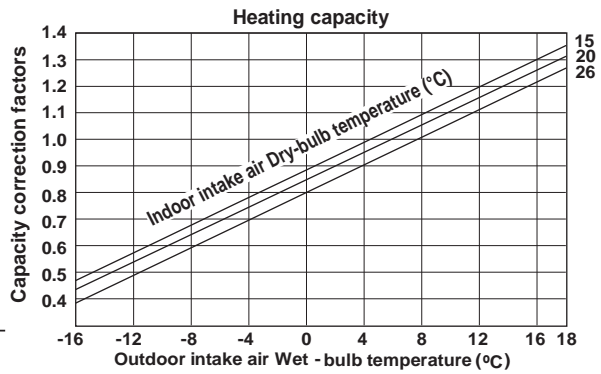

MXZ-4F83VF MXZ-5F102VF

5.4	3.8	6.8	4.8	5.0	7.3	9.0	9.9	8.2	8.6
4.9	3.5	6.2	4.4	4.6	6.7	8.2	9.0	7.5	7.9
4.5	3.2	5.7	4.0	4.2	6.0	7.4	8.1	6.8	7.1
4.0	2.9	5.1	3.6	3.8	5.4	6.7	7.3	6.1	6.4
3.6	2.6	4.5	3.2	3.4	5.8	5.9	6.4	5.4	5.7
3.2	2.3	4.0	2.8	3.0	4.2	5.2	5.6	4.7	5.0
2.8	2.0	3.5	2.5	2.6	3.7	4.5	4.9	4.1	4.3
15 class	18 class	20 class	22 class	25 class	35 class	42 class	50 class	60 class	71 class

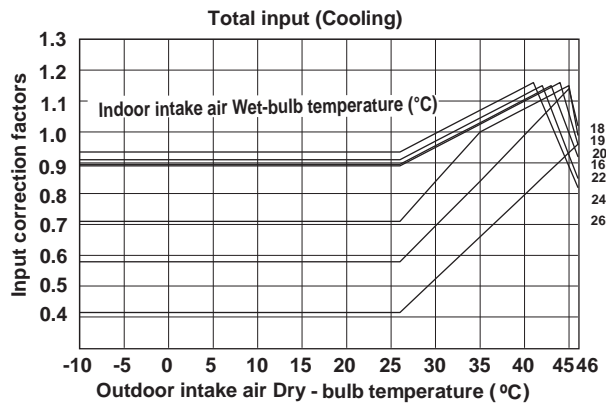
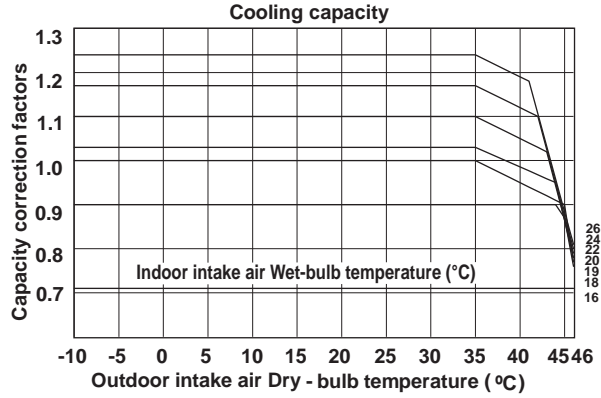

17.9	19.2	21.5	19.2	17.7	22.1	27.5	29.5	27.0	28.9
16.6	17.8	20.5	17.8	16.4	20.6	25.6	27.5	25.0	26.9
15.3	16.5	18.4	16.5	15.2	19.0	23.6	25.4	23.1	24.8
14.0	15.1	16.9	15.1	13.9	17.4	21.6	23.2	21.2	22.7
12.9	13.9	15.6	13.9	12.8	16.0	19.9	21.4	19.5	20.9
11.6	12.5	14.0	12.5	11.5	14.4	17.9	19.2	17.5	18.8
10.3	11.1	12.4	11.1	10.2	12.8	15.9	17.1	15.6	16.7
9.0	9.7	10.9	9.7	9.0	11.2	13.9	15.0	13.6	14.6
7.8	8.4	9.4	8.4	7.8	9.7	12.1	13.0	11.8	12.7
6.5	7.0	7.9	7.0	6.5	8.1	10.1	10.8	9.9	10.6
5.2	5.5	6.3	5.6	5.2	6.5	8.1	8.7	7.9	8.5
15 class	18 class	20 class	22 class	25 class	35 class	42 class	50 class	60 class	71 class

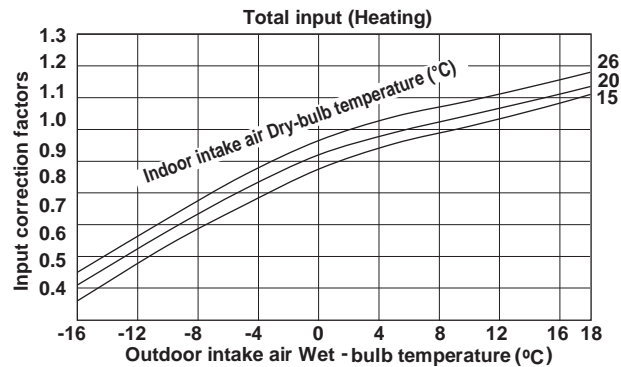
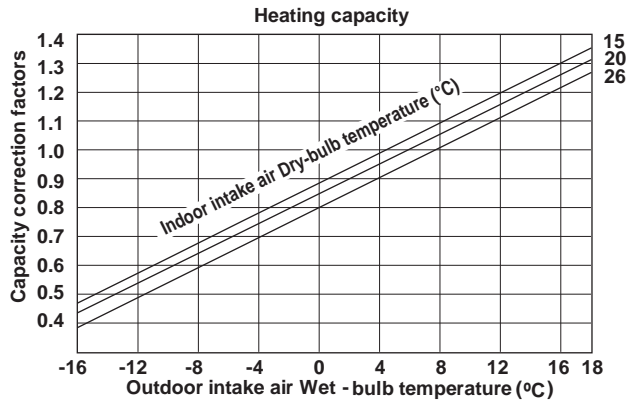

MXZ-6F122VF

5.4	3.8	6.8	4.8	5.0	7.3	9.0	9.9	8.2	8.6
4.9	3.5	6.2	4.4	4.6	6.7	8.2	9.0	7.5	7.9
4.5	3.2	5.7	4.0	4.2	6.0	7.4	8.1	6.8	7.1
4.0	2.9	5.1	3.6	3.8	5.4	6.7	7.3	6.1	6.4
3.6	2.6	4.5	3.2	3.4	5.8	5.9	6.4	5.4	5.7
3.2	2.3	4.0	2.8	3.0	4.2	5.2	5.6	4.7	5.0
2.8	2.0	3.5	2.5	2.6	3.7	4.5	4.9	4.1	4.3
15 class	18 class	20 class	22 class	25 class	35 class	42 class	50 class	60 class	71 class

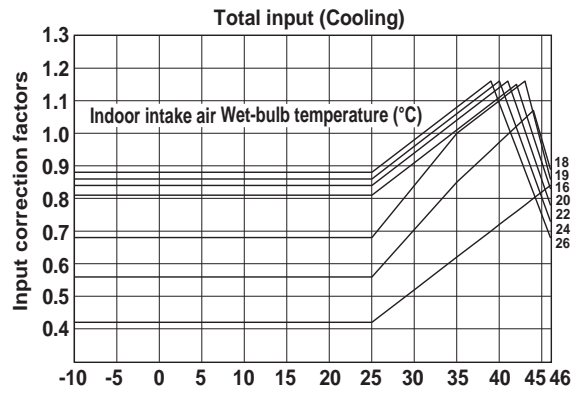
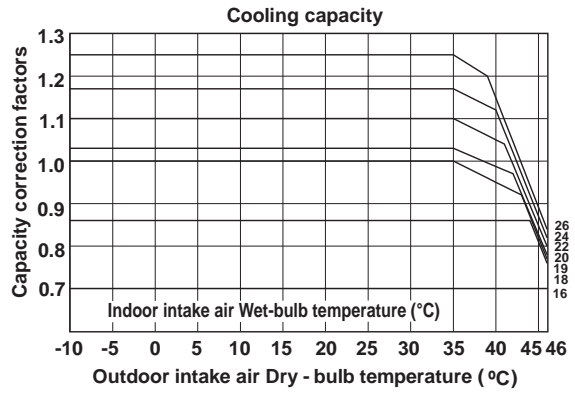

17.9	19.2	21.5	19.2	17.7	22.1	27.5	29.5	27.0	28.9
16.6	17.8	20.5	17.8	16.4	20.6	25.6	27.5	25.0	26.9
15.3	16.5	18.4	16.5	15.2	19.0	23.6	25.4	23.1	24.8
14.0	15.1	16.9	15.1	13.9	17.4	21.6	23.2	21.2	22.7
12.9	13.9	15.6	13.9	12.8	16.0	19.9	21.4	19.5	20.9
11.6	12.5	14.0	12.5	11.5	14.4	17.9	19.2	17.5	18.8
10.3	11.1	12.4	11.1	10.2	12.8	15.9	17.1	15.6	16.7
9.0	9.7	10.9	9.7	9.0	11.2	13.9	15.0	13.6	14.6
7.8	8.4	9.4	8.4	7.8	9.7	12.1	13.0	11.8	12.7
6.5	7.0	7.9	7.0	6.5	8.1	10.1	10.8	9.9	10.6
5.2	5.5	6.3	5.6	5.2	6.5	8.1	8.7	7.9	8.5
15 class	18 class	20 class	22 class	25 class	35 class	42 class	50 class	60 class	71 class

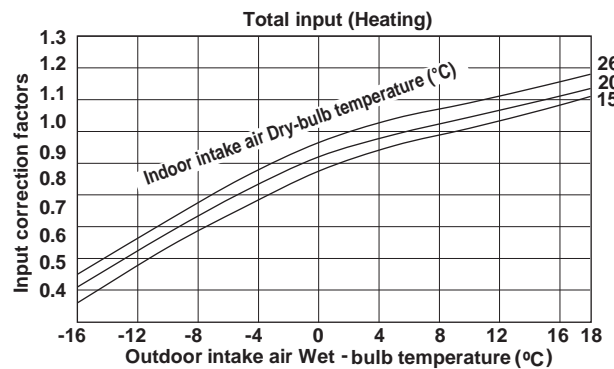
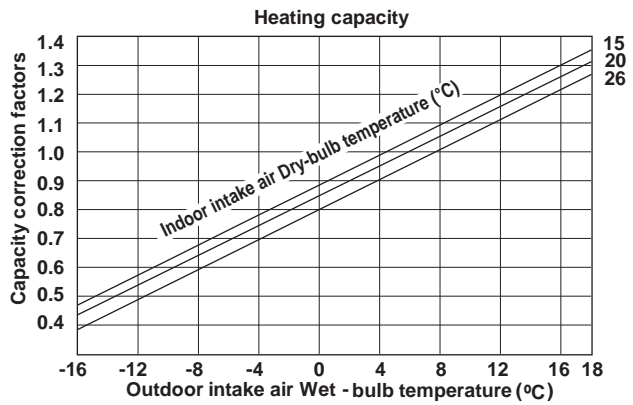

MXZ-2F53VFHZ

	5.4	3.8	6.8	4.8	5.0	7.3	9.0	9.9
Indoor air Wet-bulb temperature difference (°C)	4.9	3.5	6.2	4.4	4.6	6.7	8.2	9.0
	4.5	3.2	5.7	4.0	4.2	6.0	7.4	8.1
	4.0	2.9	5.1	3.6	3.8	5.4	6.7	7.3
	3.6	2.6	4.5	3.2	3.4	4.8	5.9	6.4
	3.2	2.3	4.0	2.8	3.0	4.2	5.2	5.6
	2.8	2.0	3.5	2.5	2.6	3.7	4.5	4.9
	15 class	18 class	20 class	22 class	25 class	35 class	42 class	50 class

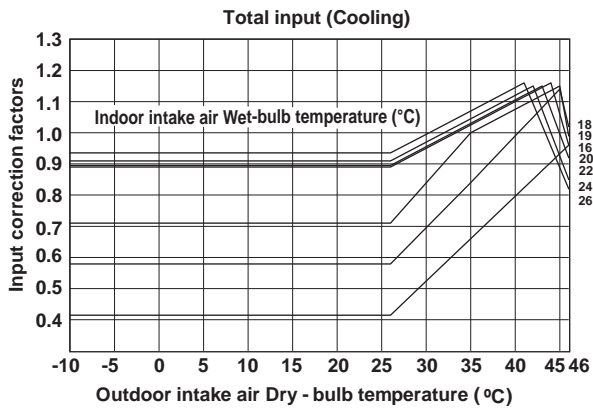
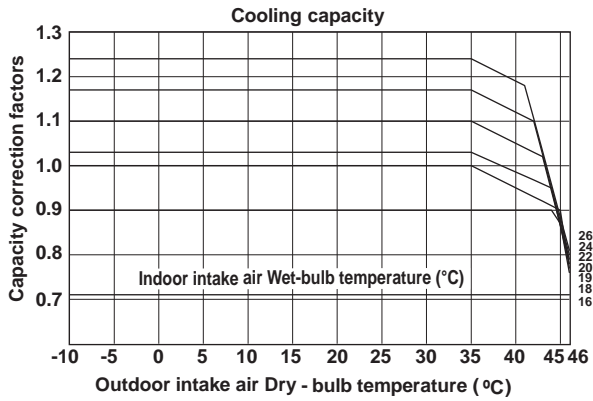

	17.9	19.2	21.5	19.2	17.7	22.1	27.5	29.6
Indoor air Dry-bulb temperature difference (°C)	16.6	17.8	20.0	17.8	16.4	20.6	25.6	27.5
	15.3	16.5	18.4	16.5	15.2	19.0	23.6	25.4
	14.0	15.1	16.9	15.1	13.9	17.4	21.6	23.2
	12.9	13.9	15.6	13.9	12.8	16.0	19.9	21.4
	11.6	12.5	14.0	12.5	11.5	14.4	17.9	19.2
	10.3	11.1	12.4	11.1	10.2	12.8	15.9	17.1
	9.0	9.7	10.9	9.7	9.0	11.2	13.9	15.0
	7.8	8.4	9.4	8.4	7.8	9.7	12.1	13.0
	6.5	7.0	7.9	7.0	6.5	8.1	10.1	10.8
	15 class	18 class	20 class	22 class	25 class	35 class	42 class	50 class

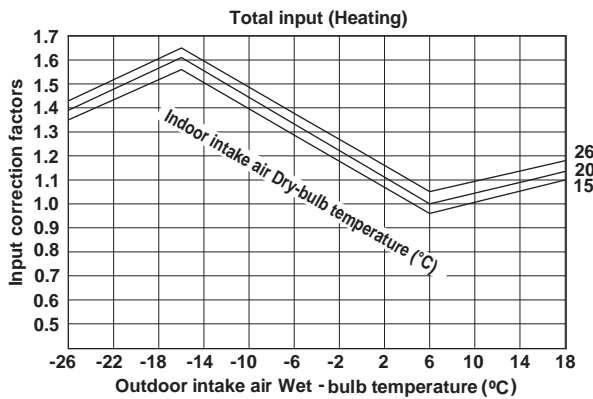
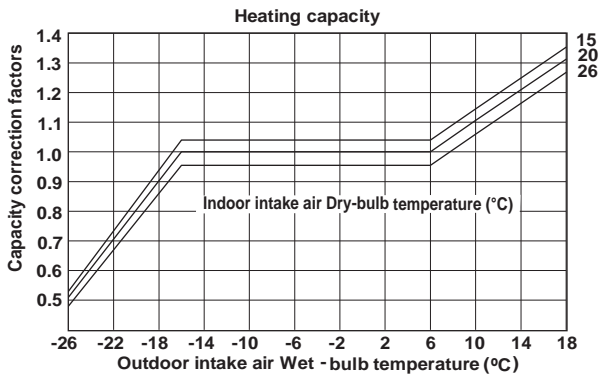

MXZ-4F83VFHZ

5.4	3.8	6.8	4.8	5.0	7.3	9.0	9.9	8.2	8.6
4.9	3.5	6.2	4.4	4.6	6.7	8.2	9.0	7.5	7.9
4.5	3.2	5.7	4.0	4.2	6.0	7.4	8.1	6.8	7.1
4.0	2.9	5.1	3.6	3.8	5.4	6.7	7.3	6.1	6.4
3.6	2.6	4.5	3.2	3.4	5.8	5.9	6.4	5.4	5.7
3.2	2.3	4.0	2.8	3.0	4.2	5.2	5.6	4.7	5.0
2.8	2.0	3.5	2.5	2.6	3.7	4.5	4.9	4.1	4.3
15 class	18 class	20 class	22 class	25 class	35 class	42 class	50 class	60 class	71 class

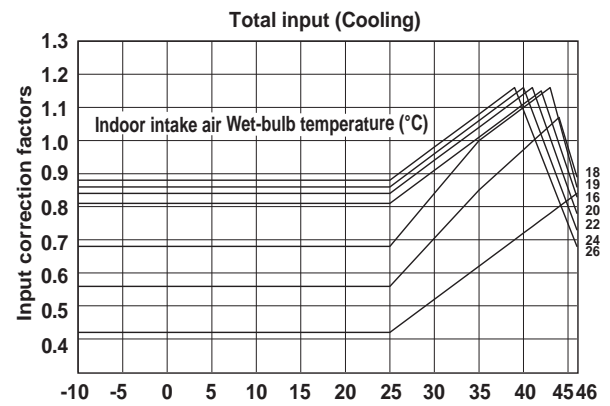
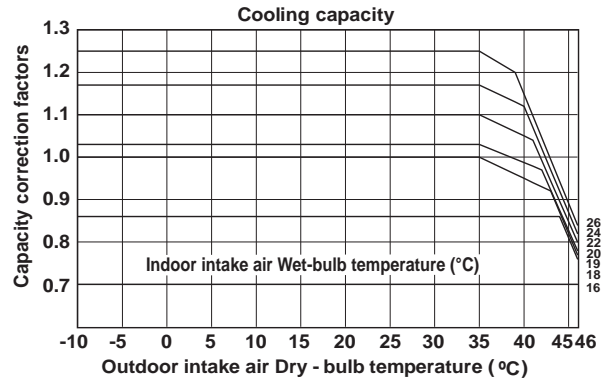

17.9	19.2	21.5	19.2	17.7	22.1	27.5	29.5	27.0	28.9
16.6	17.8	20.5	17.8	16.4	20.6	25.6	27.5	25.0	26.9
15.3	16.5	18.4	16.5	15.2	19.0	23.6	25.4	23.1	24.8
14.0	15.1	16.9	15.1	13.9	17.4	21.6	23.2	21.2	22.7
12.9	13.9	15.6	13.9	12.8	16.0	19.9	21.4	19.5	20.9
11.6	12.5	14.0	12.5	11.5	14.4	17.9	19.2	17.5	18.8
10.3	11.1	12.4	11.1	10.2	12.8	15.9	17.1	15.6	16.7
9.0	9.7	10.9	9.7	9.0	11.2	13.9	15.0	13.6	14.6
7.8	8.4	9.4	8.4	7.8	9.7	12.1	13.0	11.8	12.7
6.5	7.0	7.9	7.0	6.5	8.1	10.1	10.8	9.9	10.6
5.2	5.5	6.3	5.6	5.2	6.5	8.1	8.7	7.9	8.5
15 class	18 class	20 class	22 class	25 class	35 class	42 class	50 class	60 class	71 class

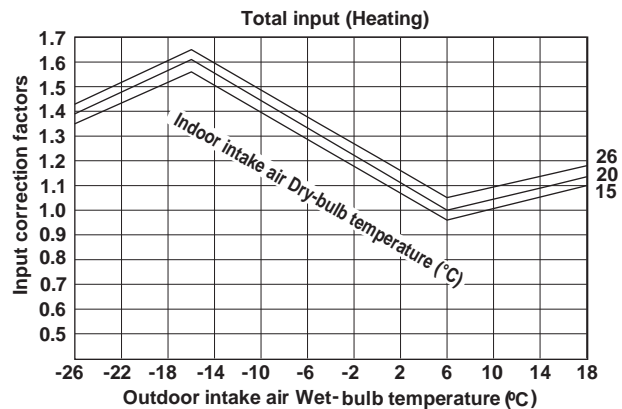
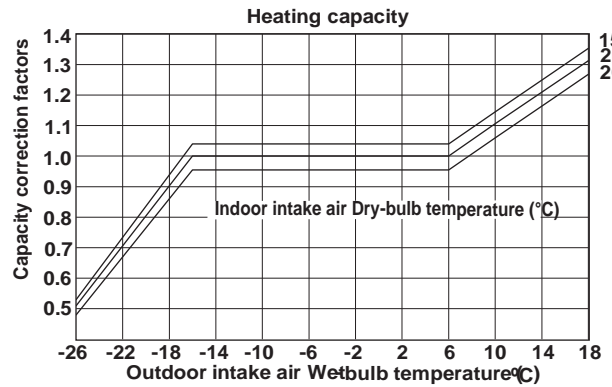

9-2. CAPACITY AND INPUT CORRECTION BY INVERTER OUTPUT FREQUENCY (single operation) MXZ-2F33VF MXZ-2F33VF2 MXZ-2F33VF3

15-class unit

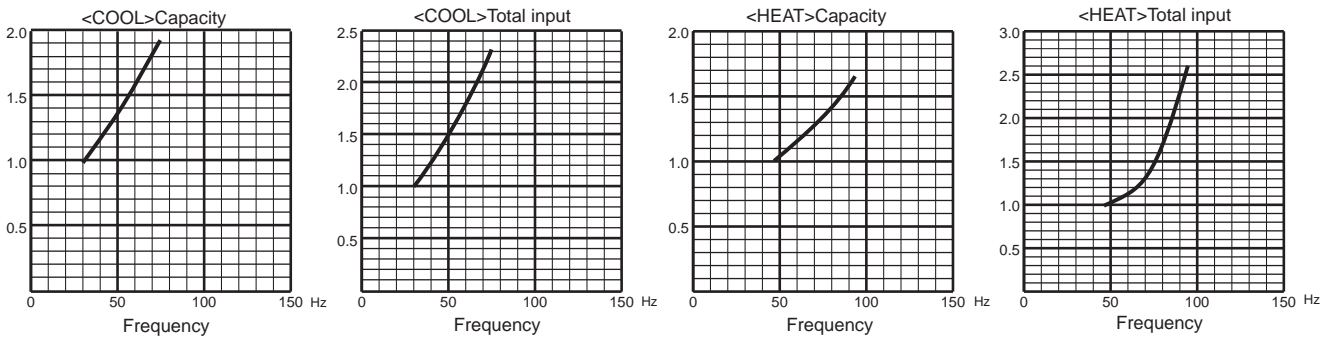

18-class unit

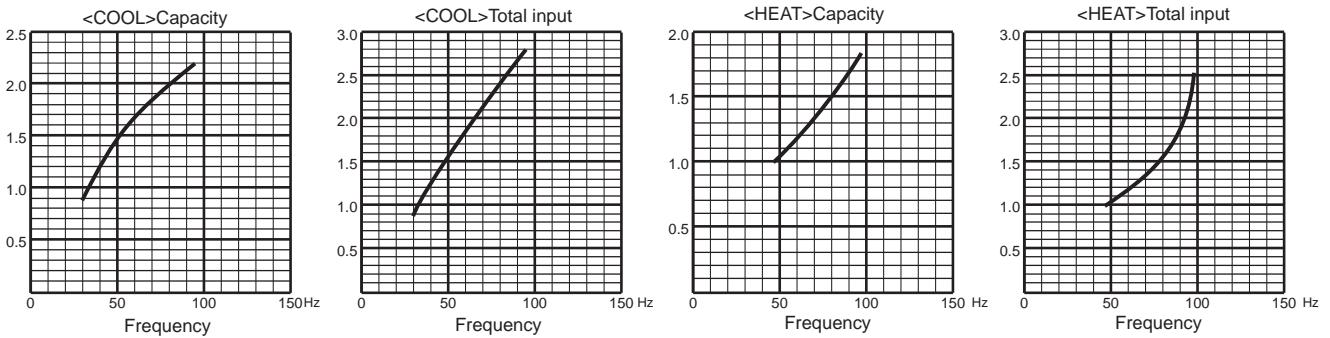

20-class unit

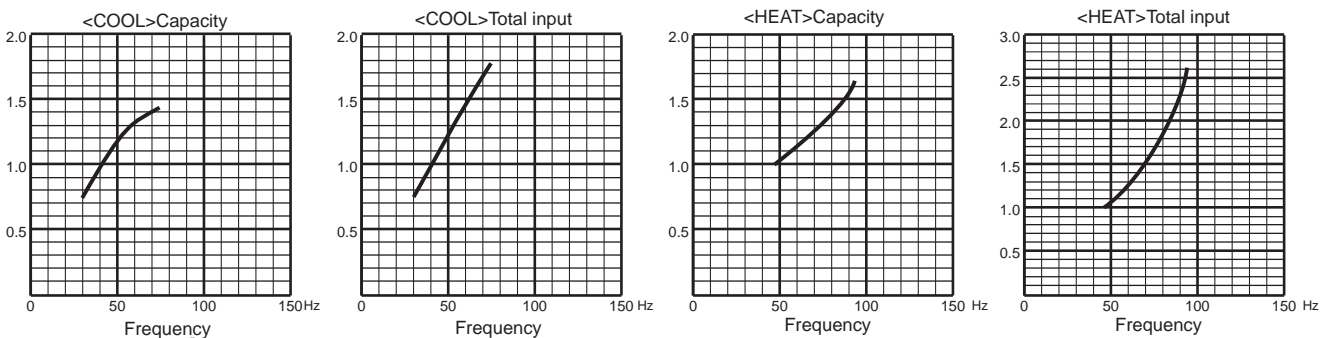

22-class unit

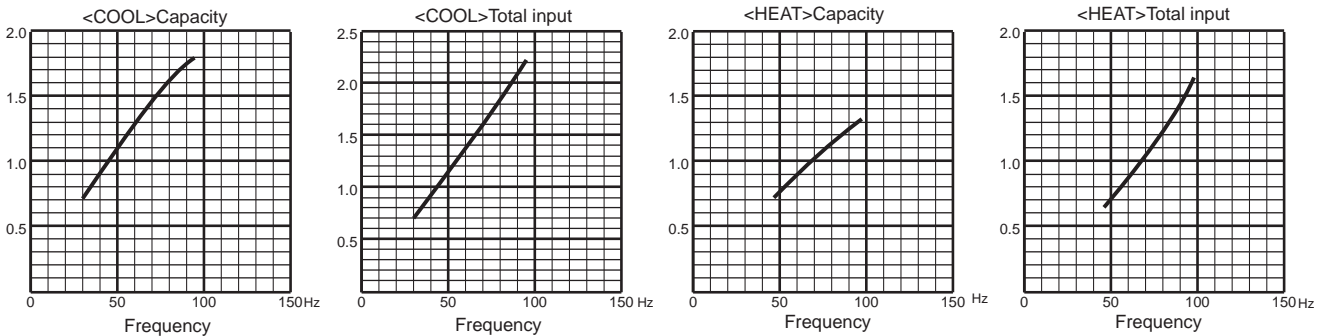

25-class unit

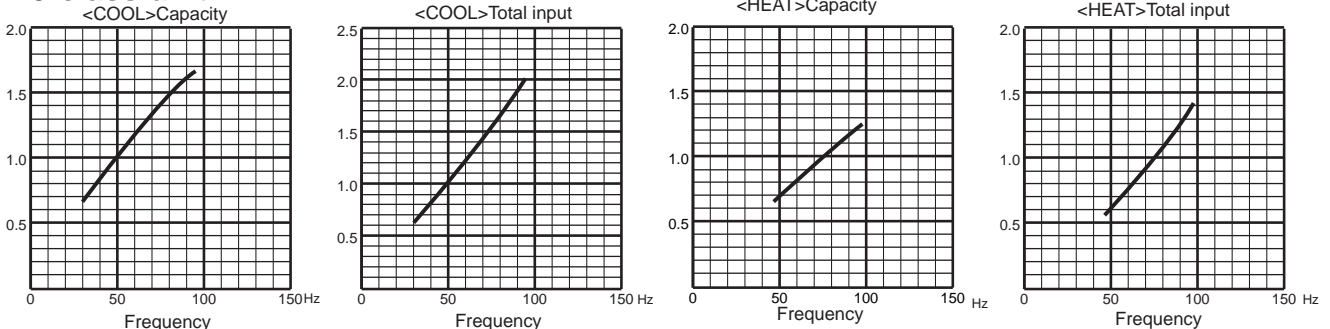

MXZ-2F42VF MXZ-2F42VF2 MXZ-2F42VF3

15-class unit

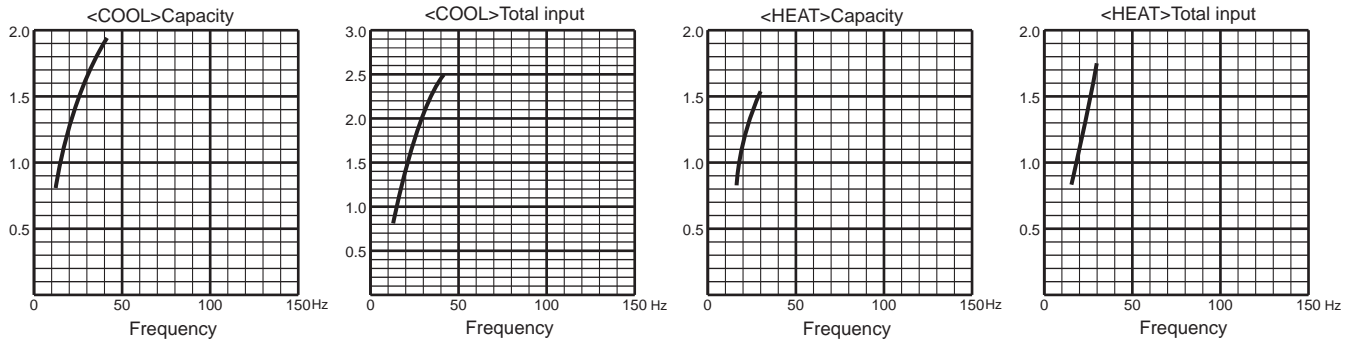

18-class unit

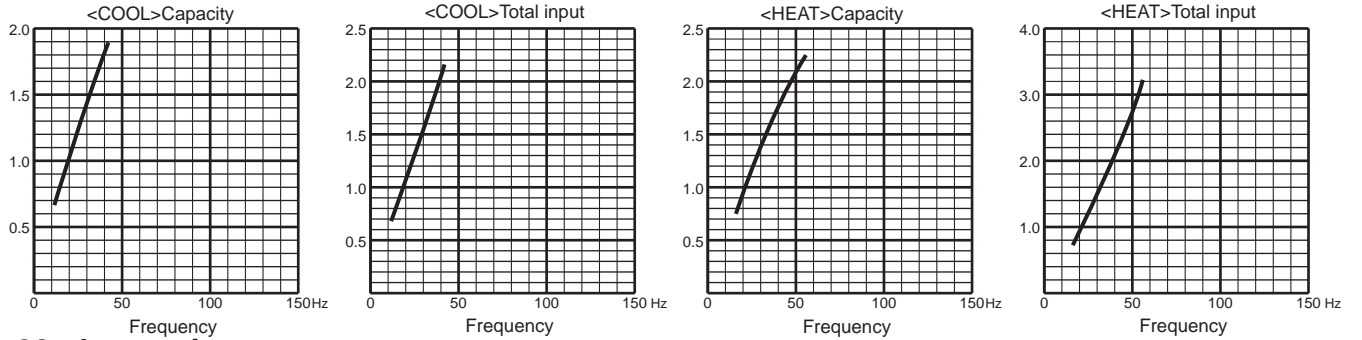

20-class unit

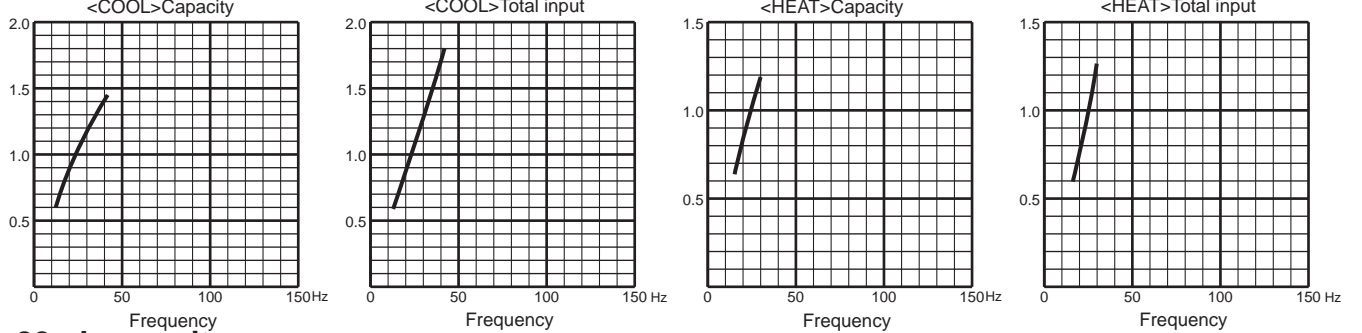

22-class unit

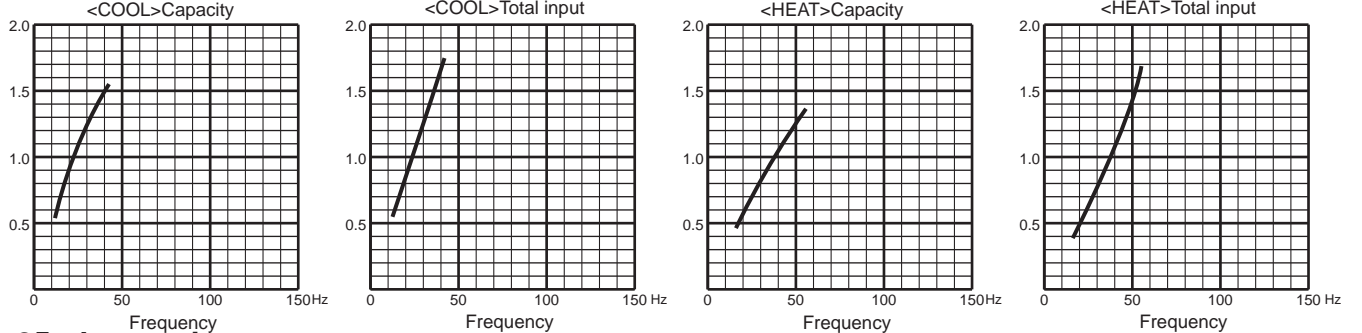

25-class unit

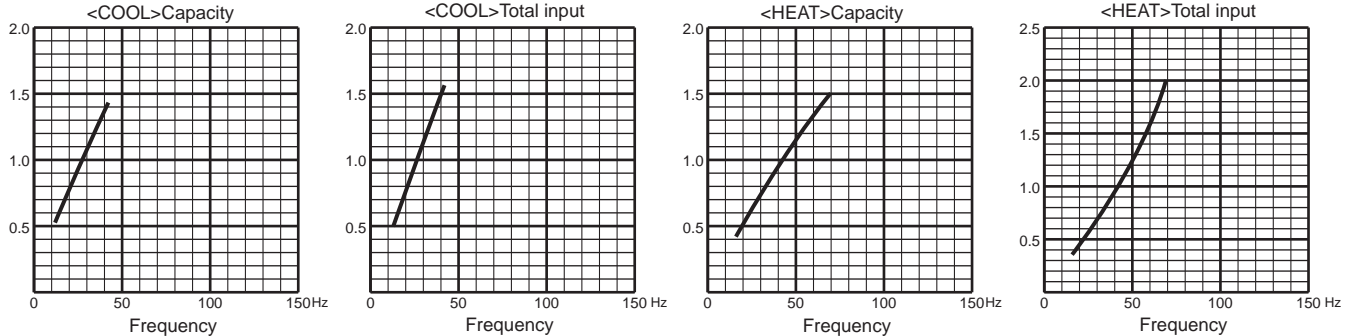

MXZ-2F42VF MXZ-2F42VF2 MXZ-2F42VF3

35-class unit

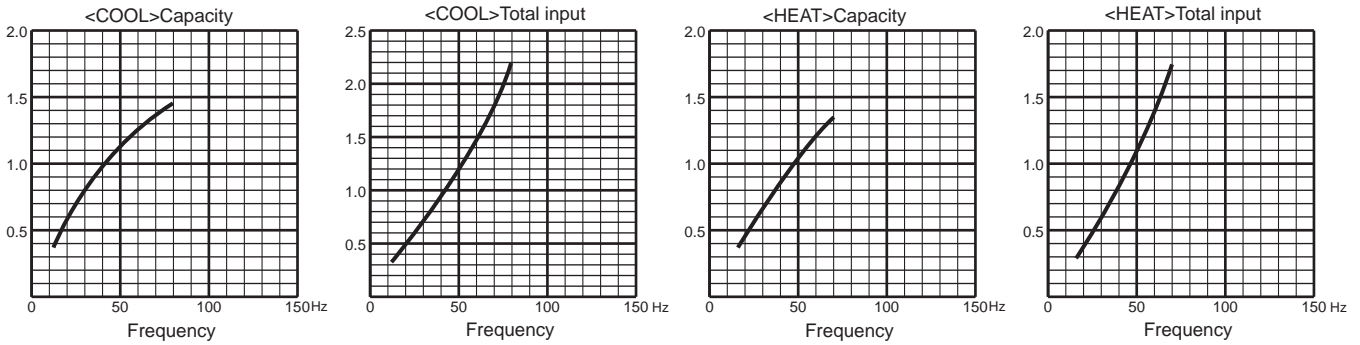

MXZ-2F53VF MXZ-2F53VF2 MXZ-2F53VF3 MXZ-2F53VFH MXZ-2F53VFH2 MXZ-2F53VFH3

15-class unit

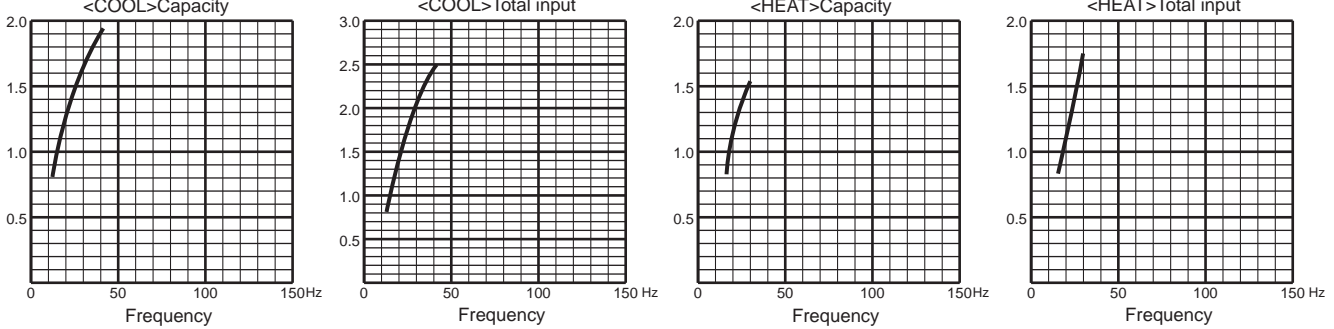

18-class unit

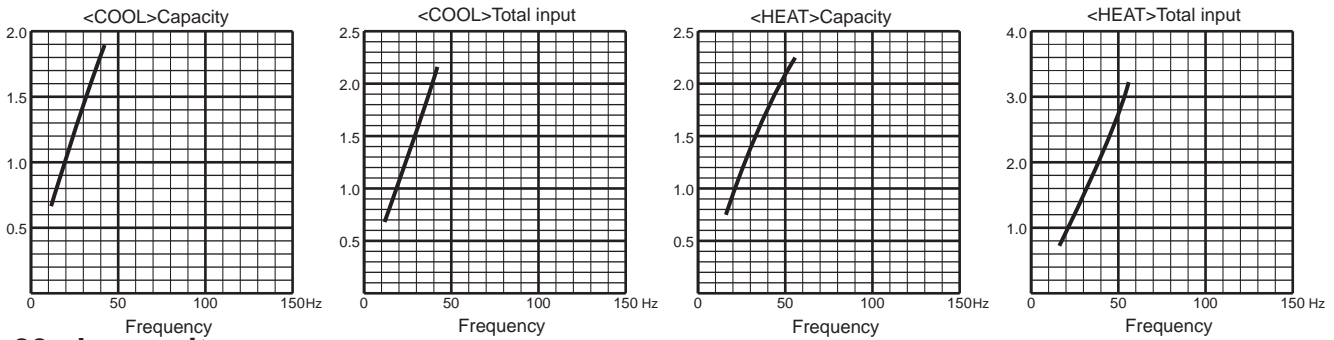

20-class unit

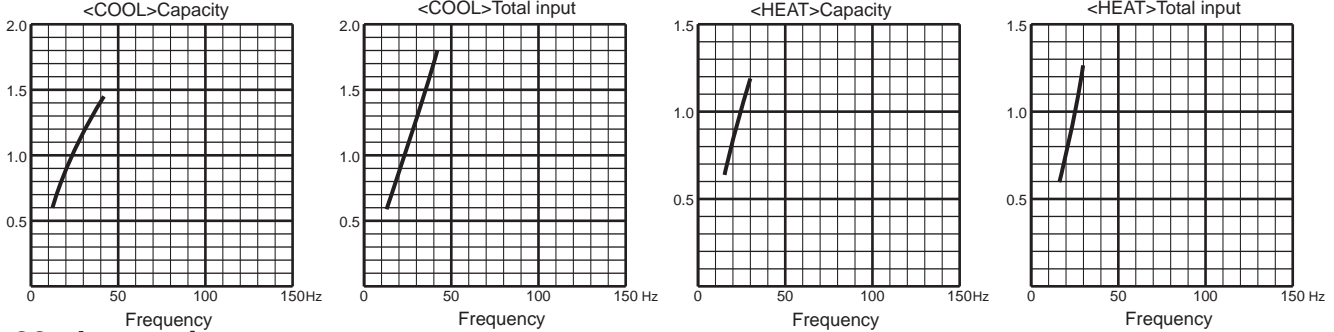

22-class unit

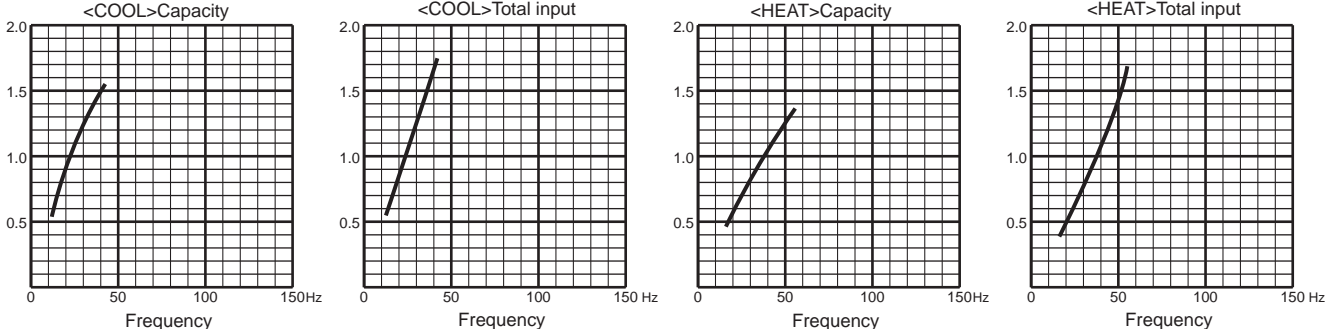

MXZ-2F53VF MXZ-2F53VF2 MXZ-2F53VF3 MXZ-2F53VFH MXZ-2F53VFH2 MXZ-2F53VFH3

25-class unit

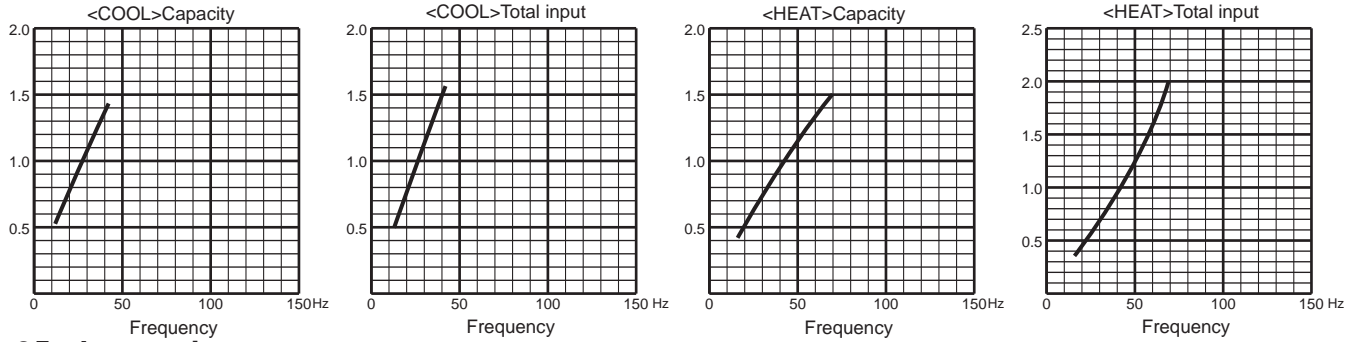

35-class unit

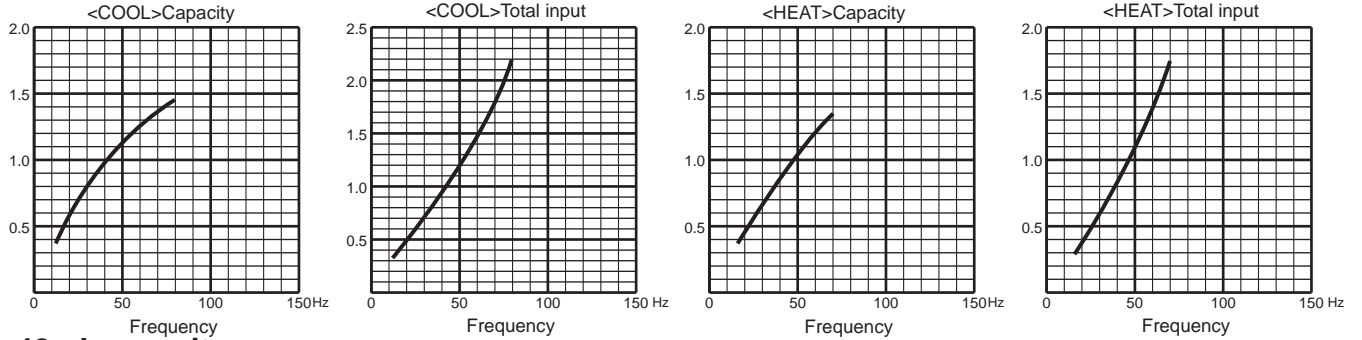

42-class unit

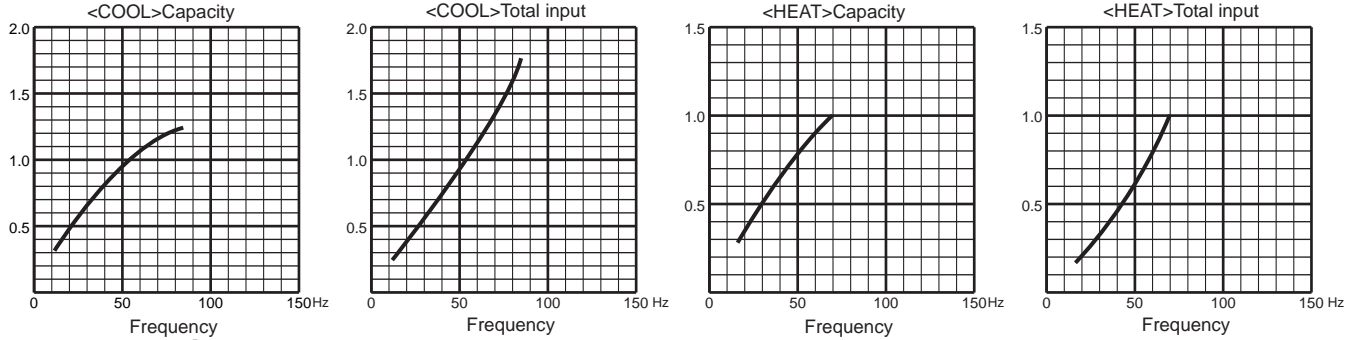

50-class unit

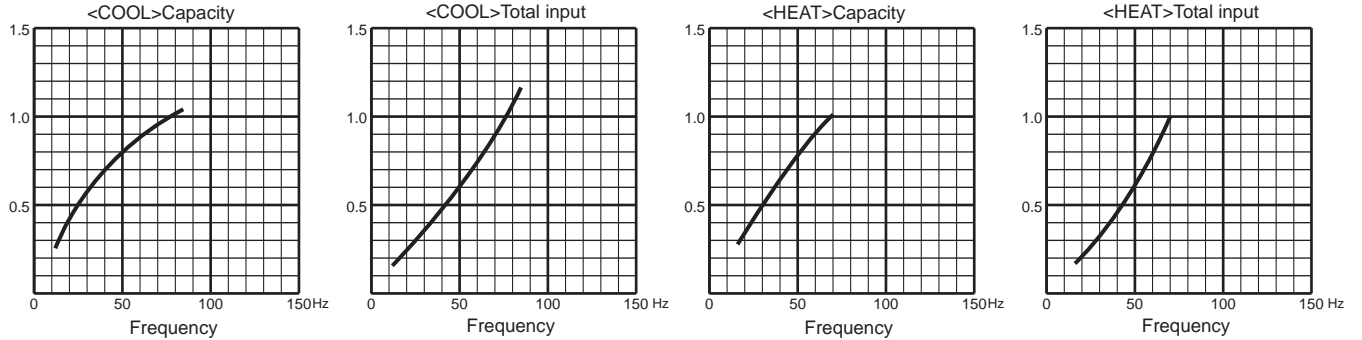

MXZ-3F54VF MXZ-3F54VF2 MXZ-3F54VF3

15-class unit

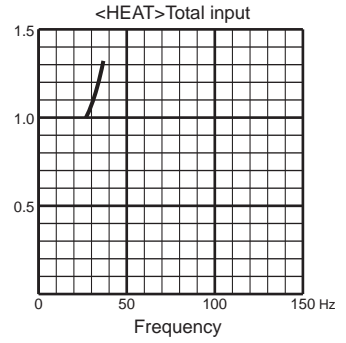
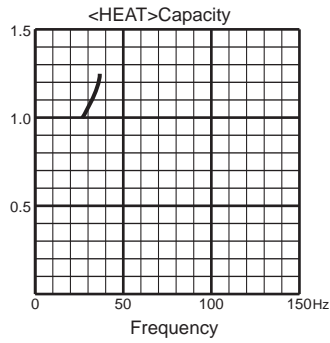
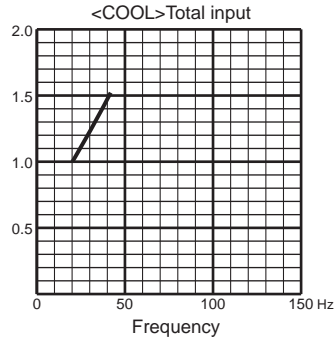
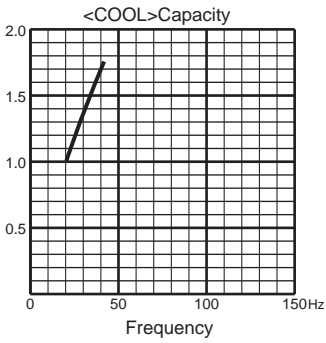

18-class unit

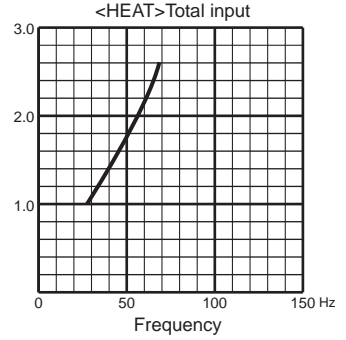
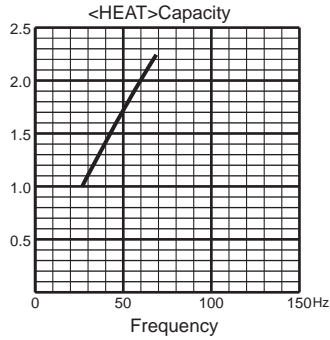
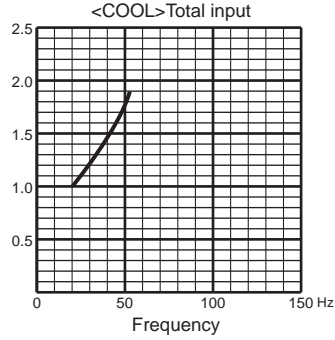
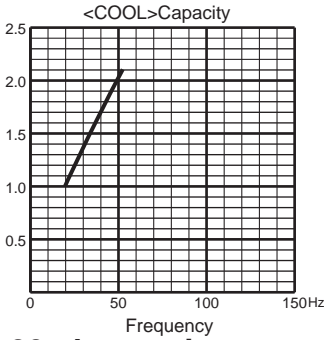

20-class unit

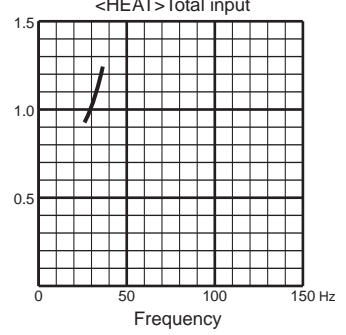
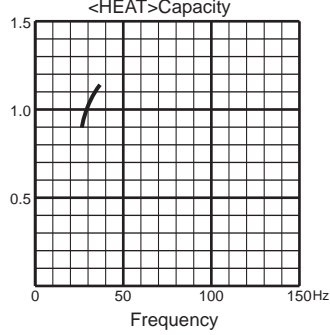
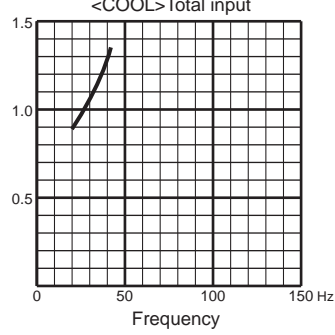
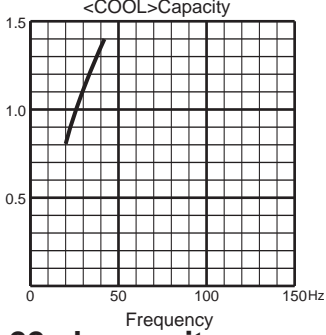

22-class unit

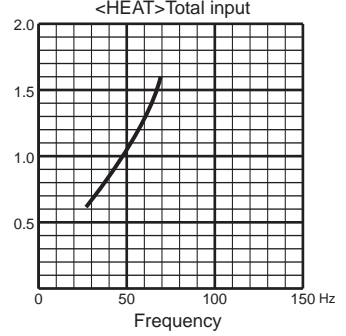
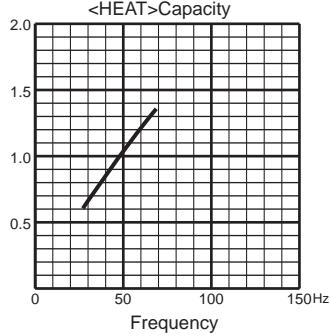
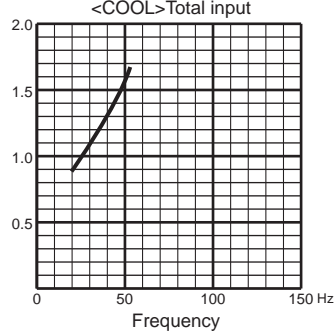
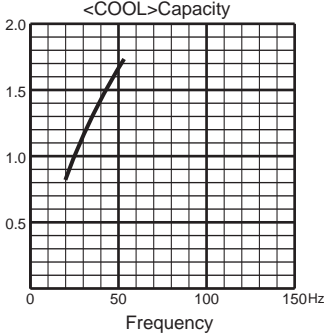

MXZ-3F54VF MXZ-3F54VF2 MXZ-3F54VF3

25-class unit

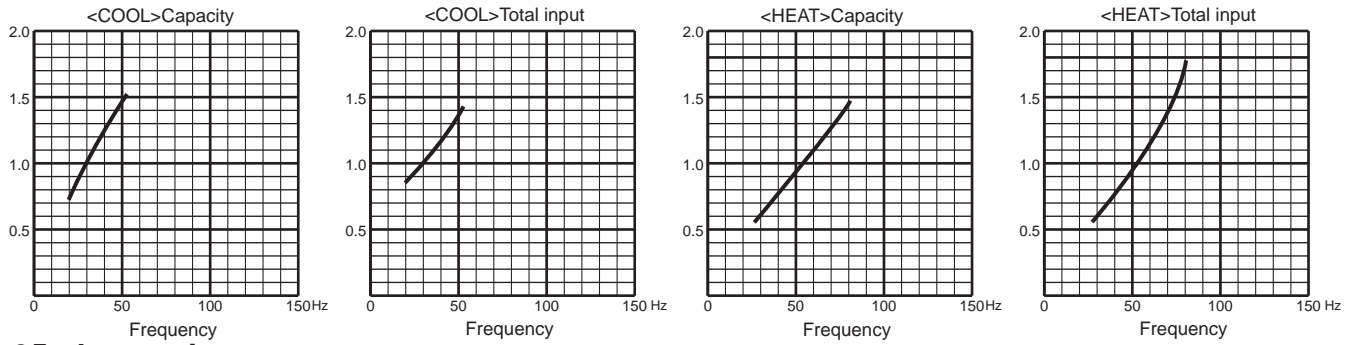

35-class unit

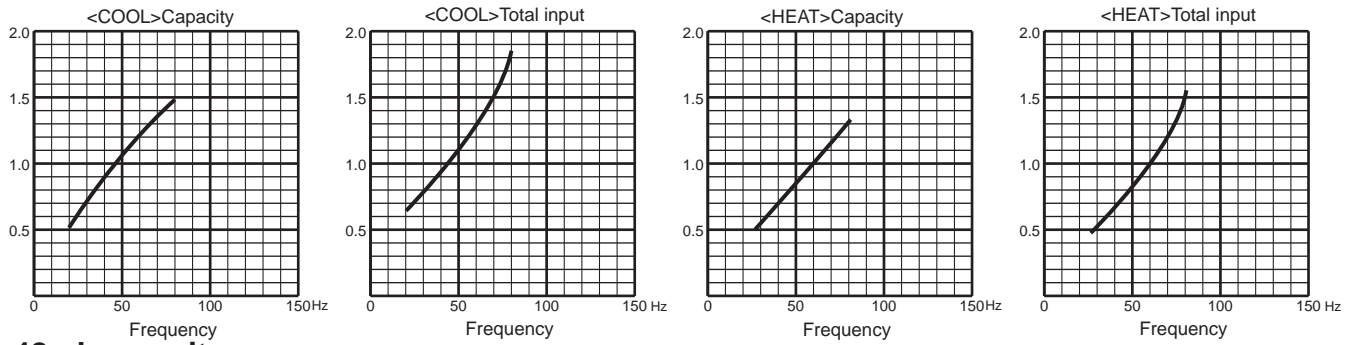

42-class unit

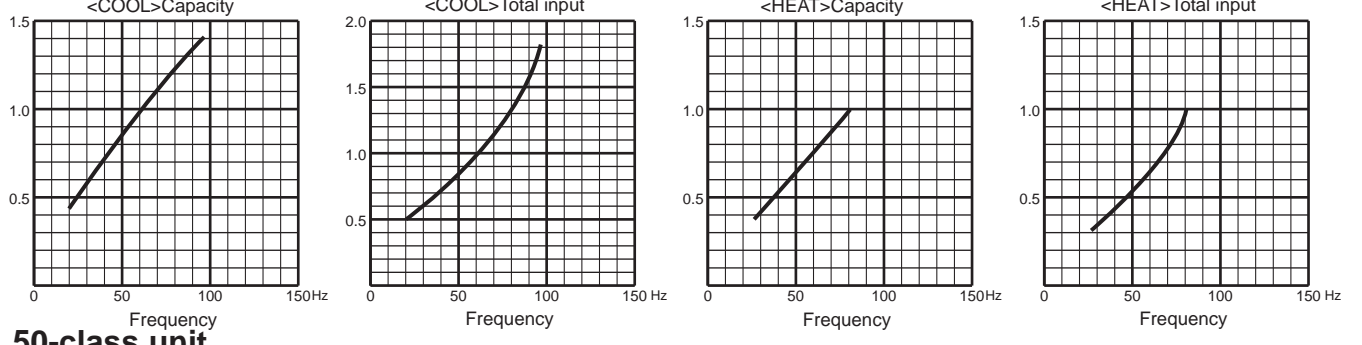

50-class unit

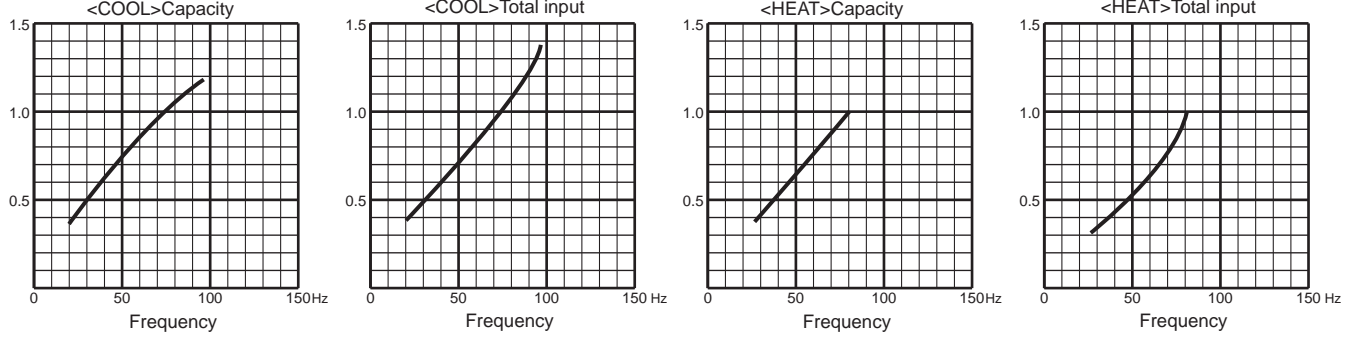

MXZ-3F68VF MXZ-3F68VF2 MXZ-3F68VF3
15-class unit

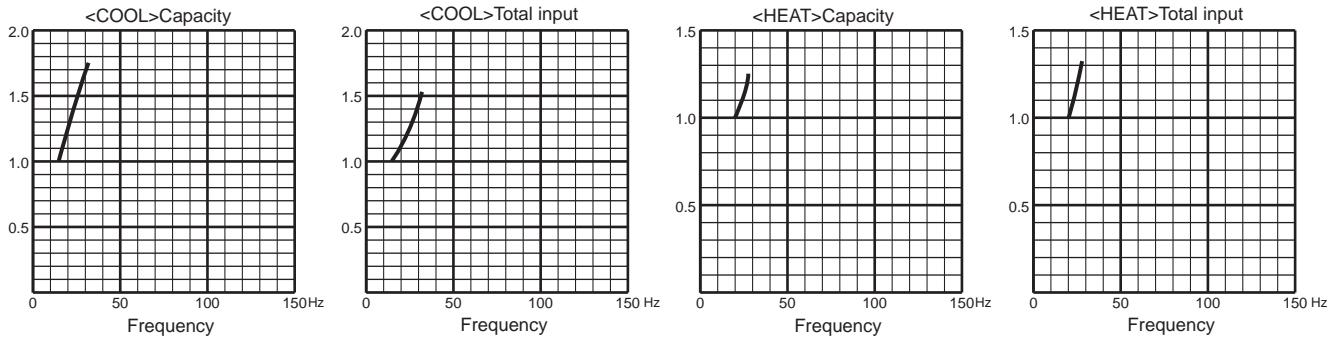

18-class unit

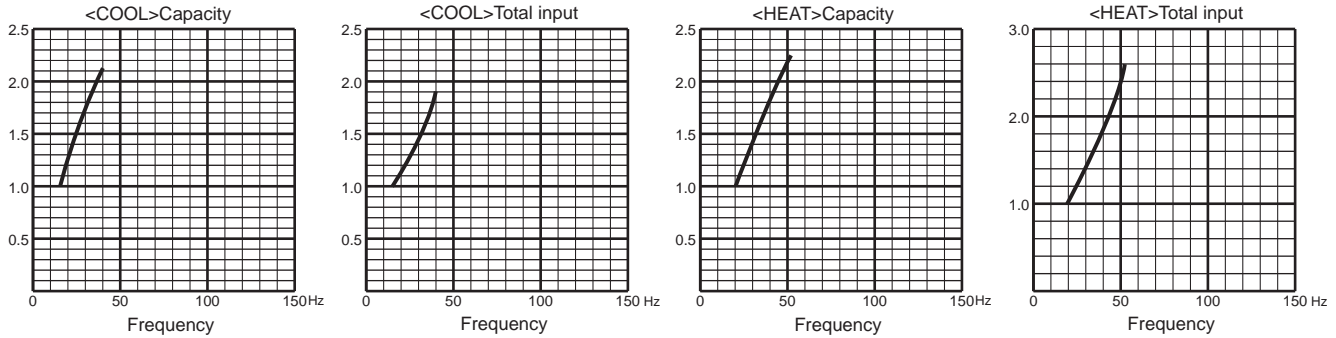

20-class unit

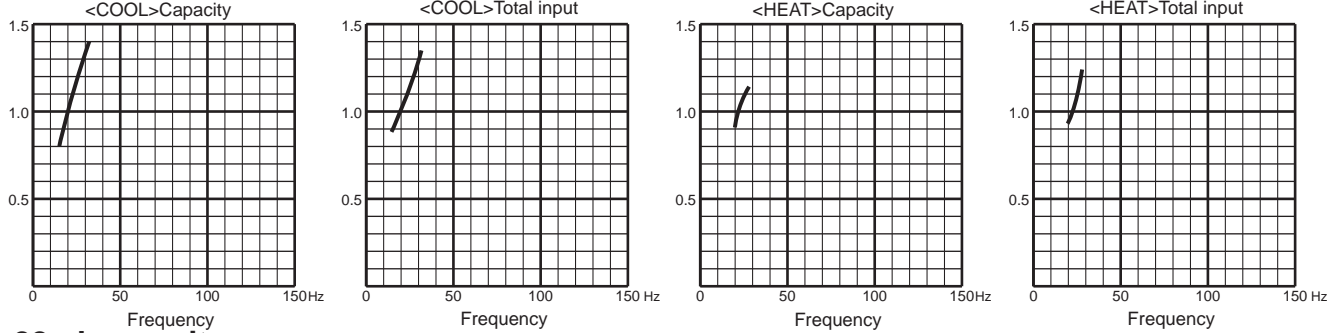

22-class unit

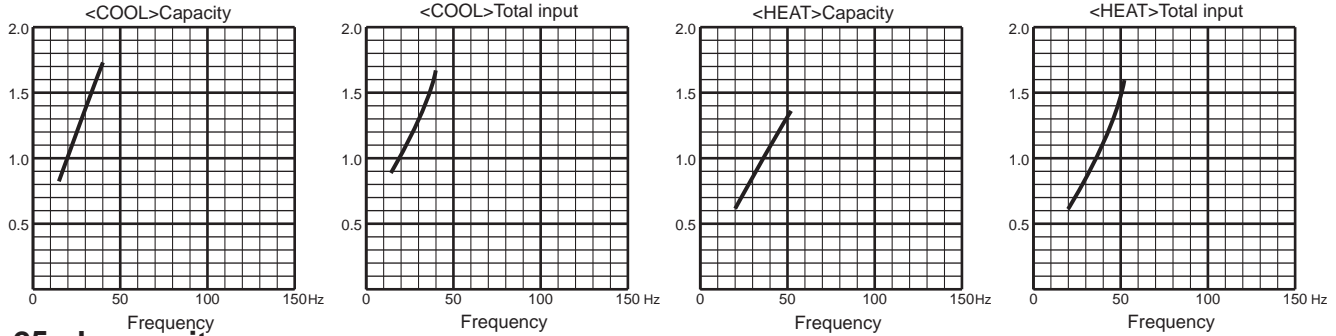

25-class unit

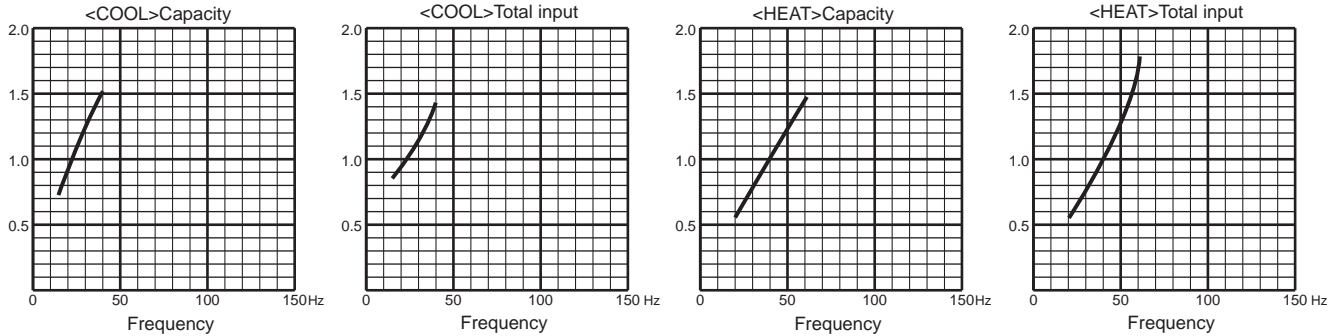

MXZ-3F68VF MXZ-3F68VF2 MXZ-3F68VF3
35-class unit

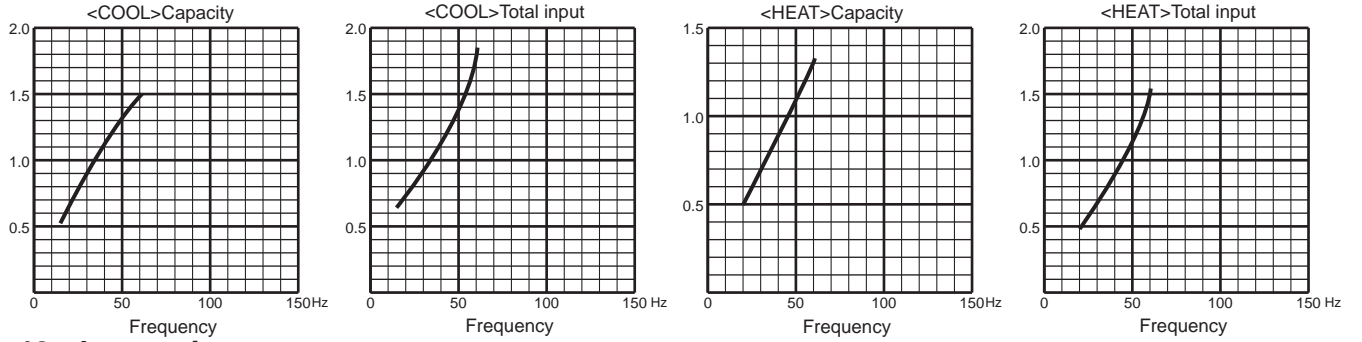

42-class unit

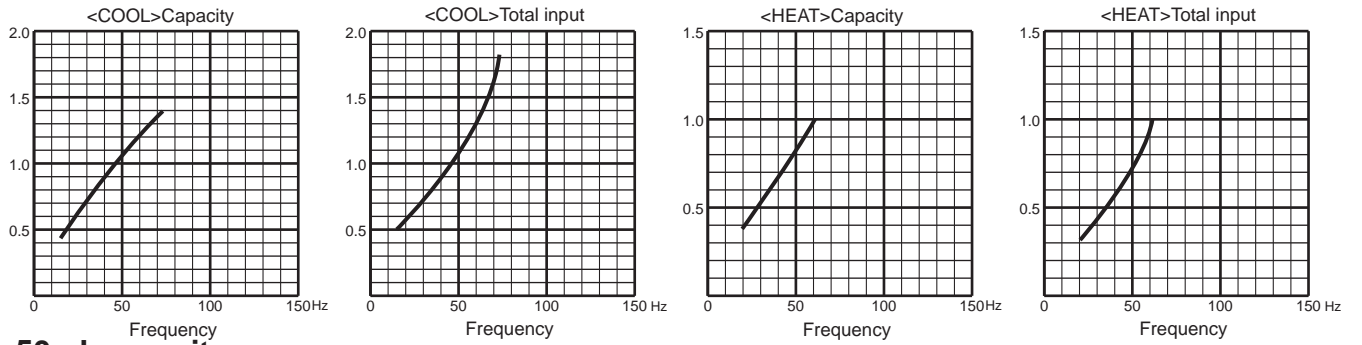

50-class unit

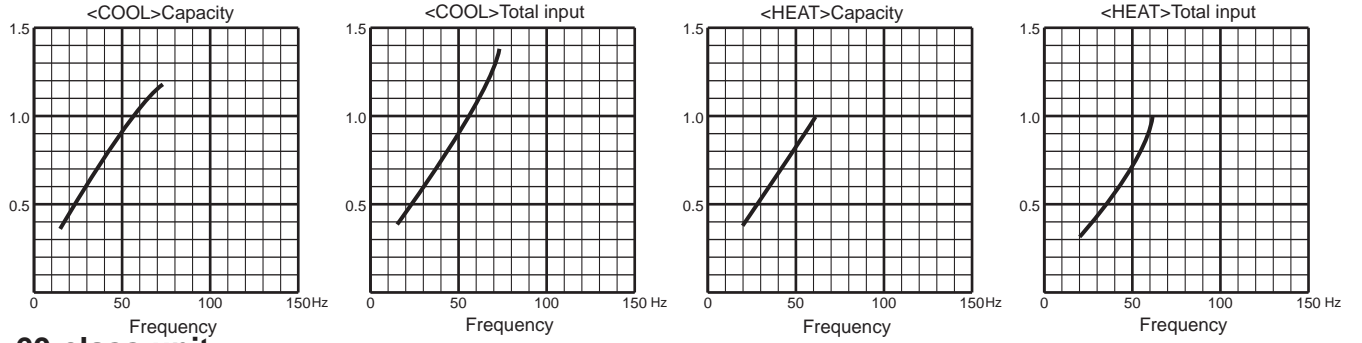

60-class unit

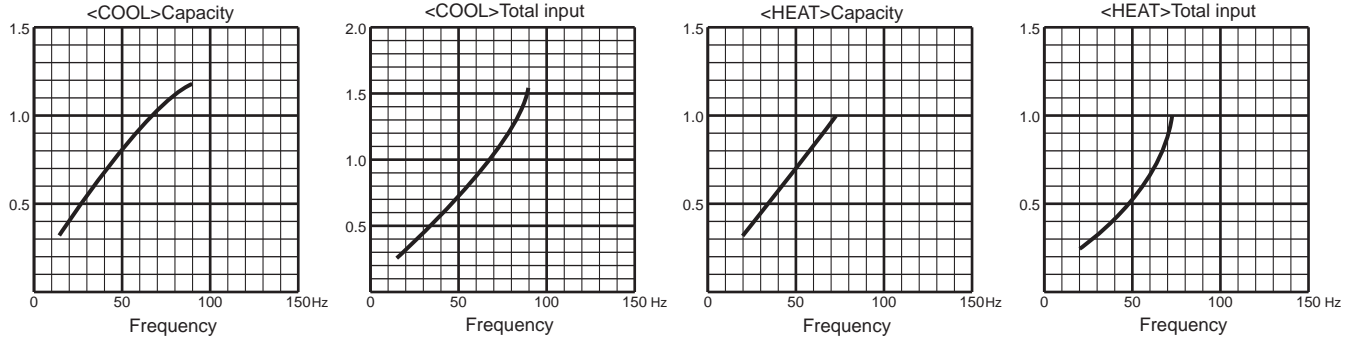

MXZ-4F72VF MXZ-4F72VF2 MXZ-4F72VF3
15-class unit

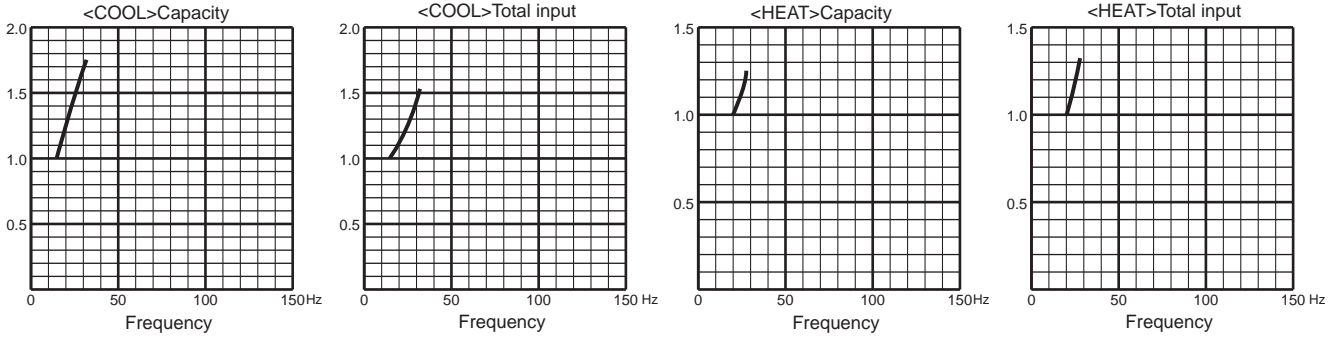

18-class unit

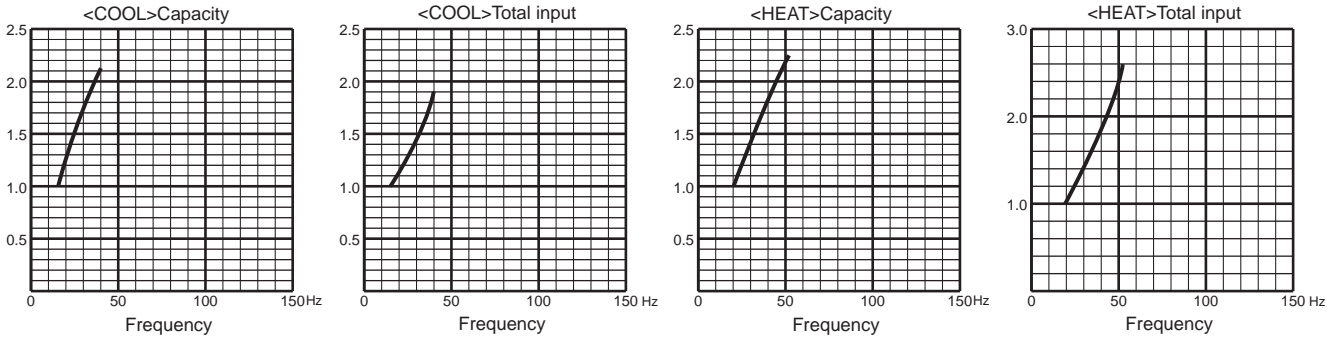

20-class unit

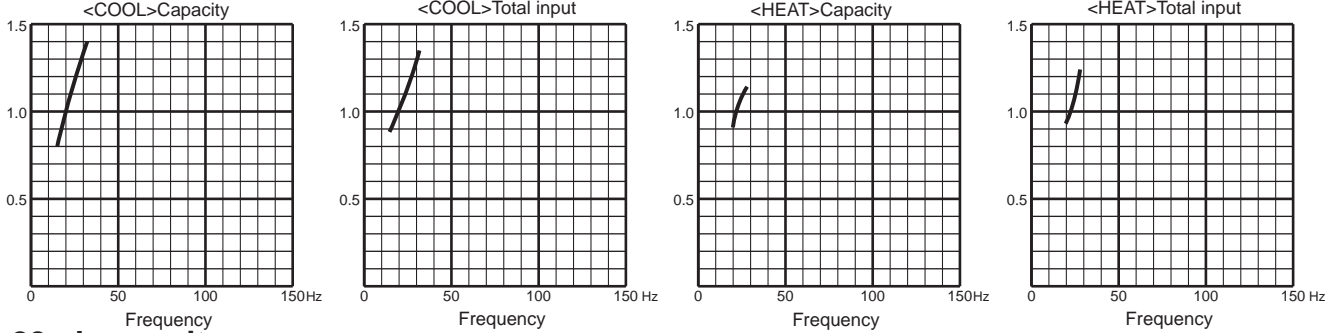

22-class unit

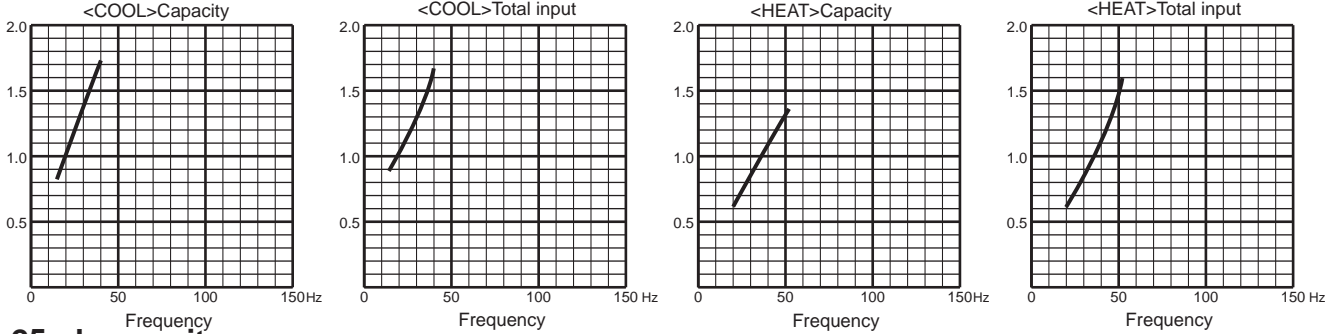

25-class unit

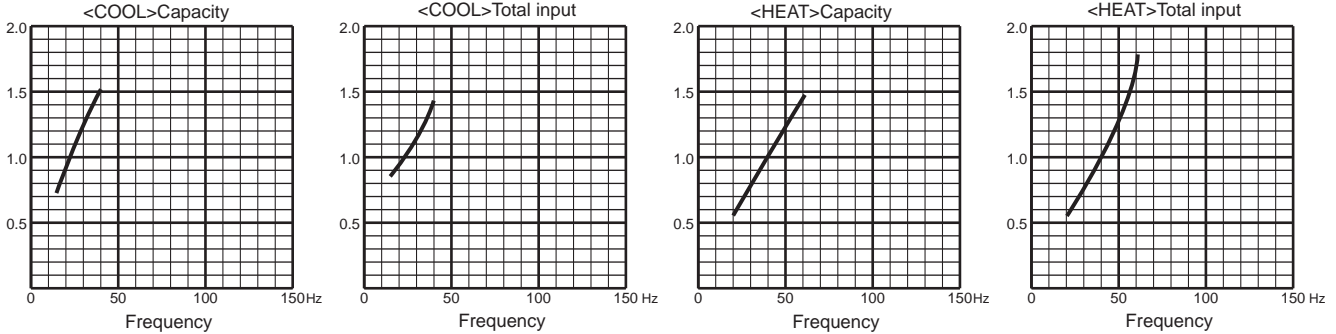

MXZ-4F72VF MXZ-4F72VF2 MXZ-4F72VF3

35-class unit

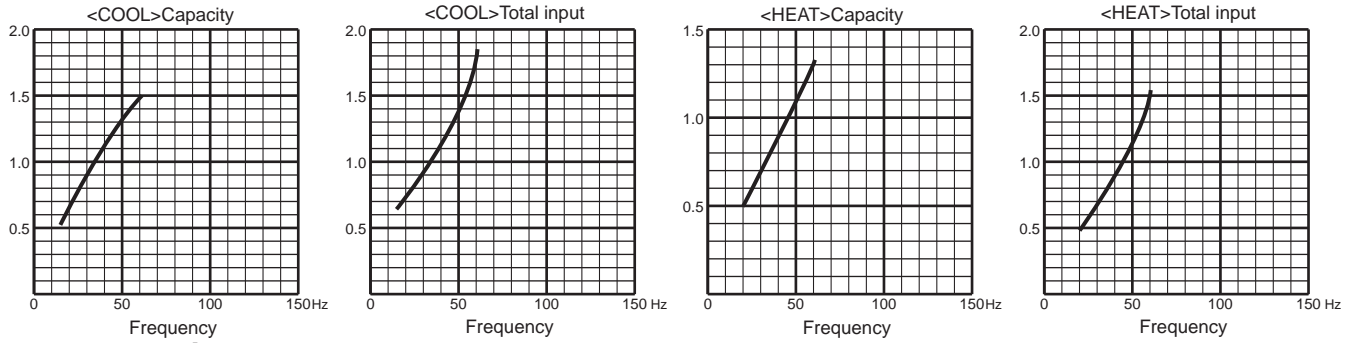

42-class unit

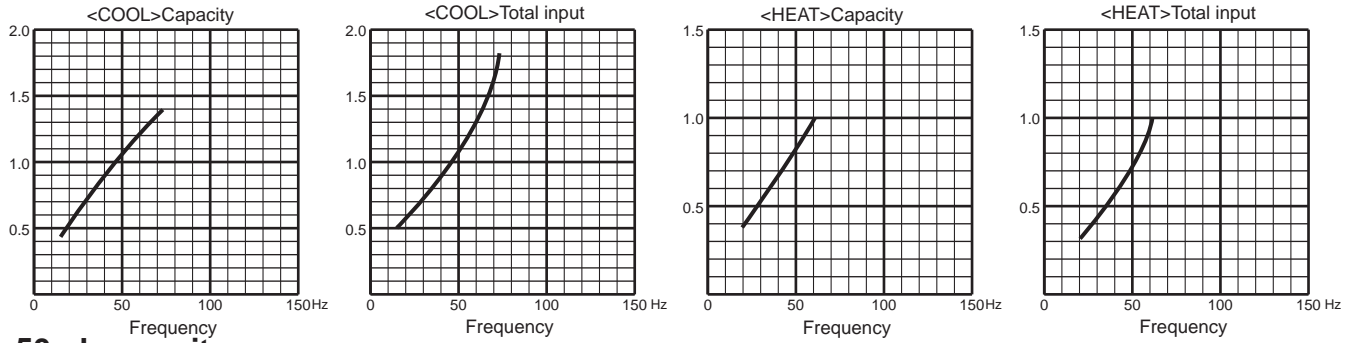

50-class unit

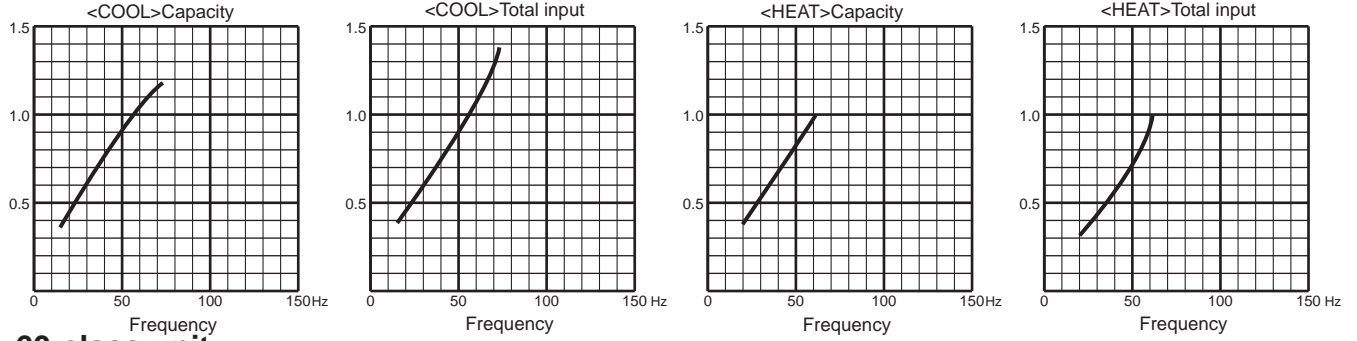

60-class unit

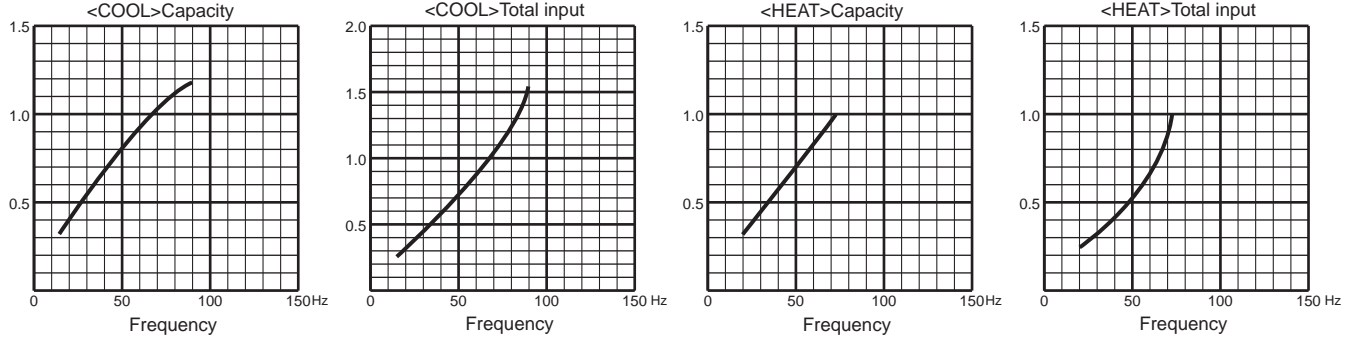

MXZ-4F80VF2 MXZ-4F80VF3
15-class unit

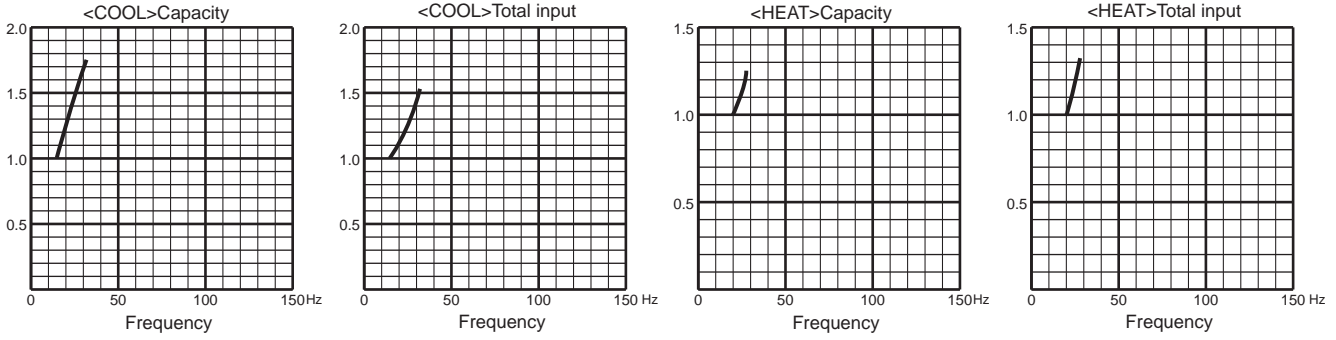

18-class unit

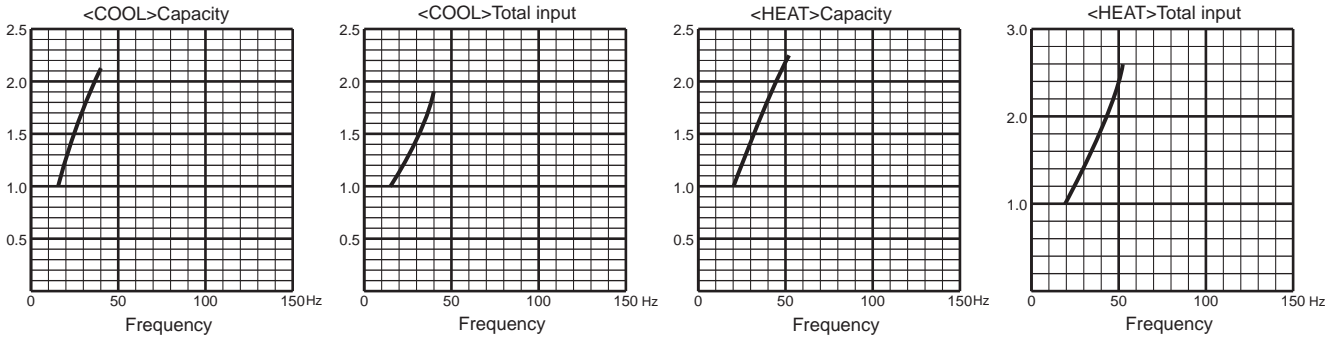

20-class unit

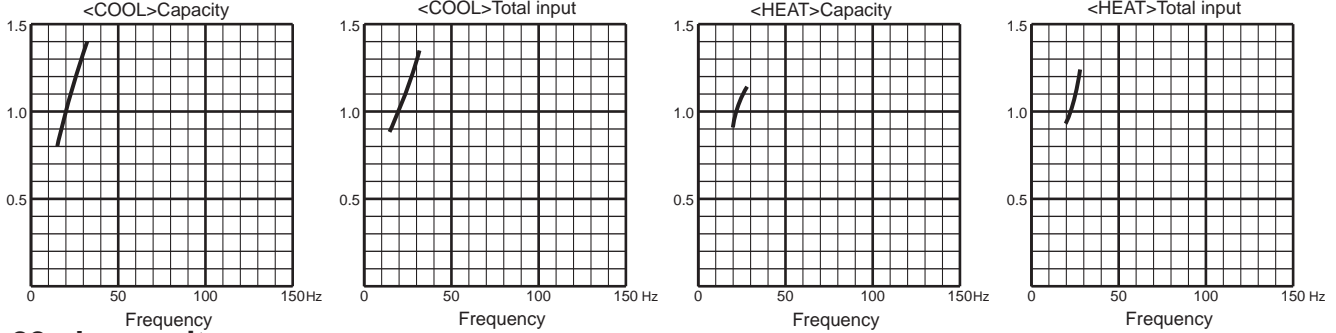

22-class unit

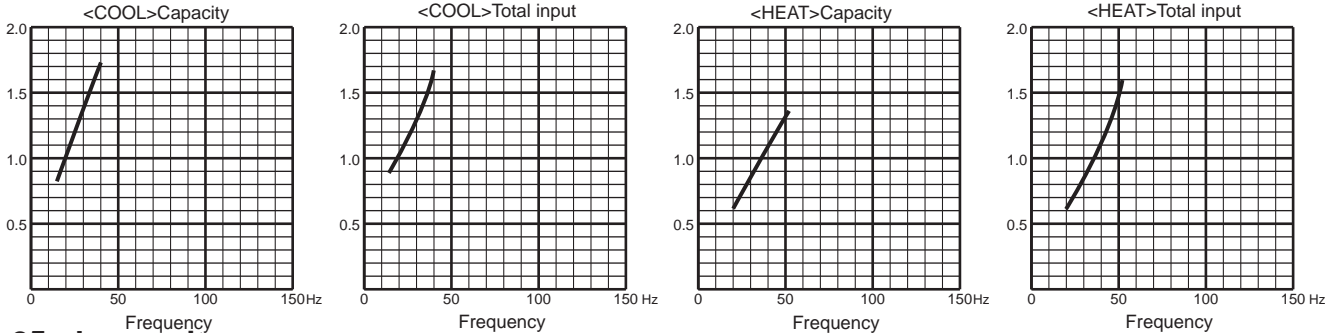

25-class unit

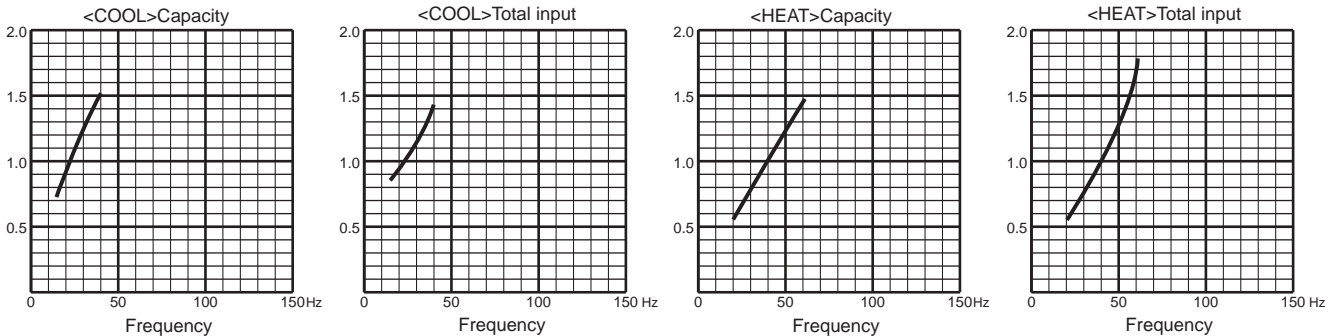

MXZ-4F80VF2 MXZ-4F80VF3

35-class unit

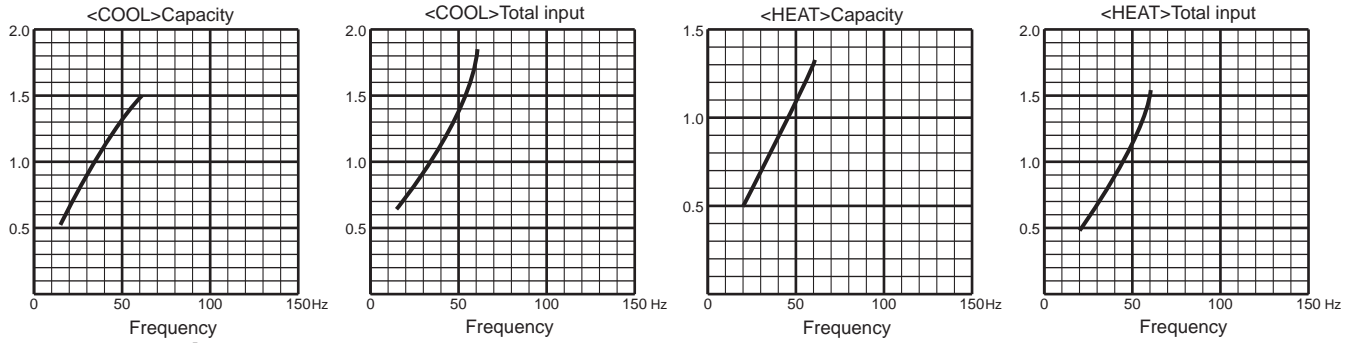

42-class unit

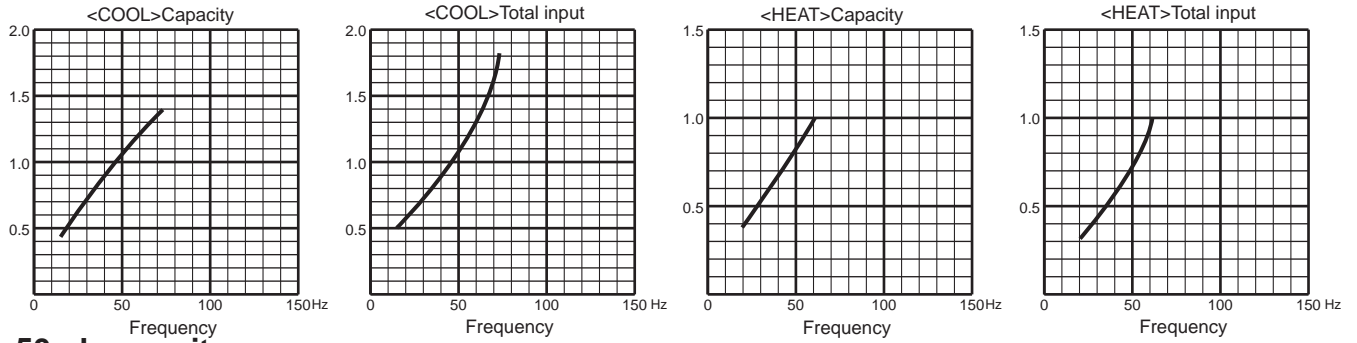

50-class unit

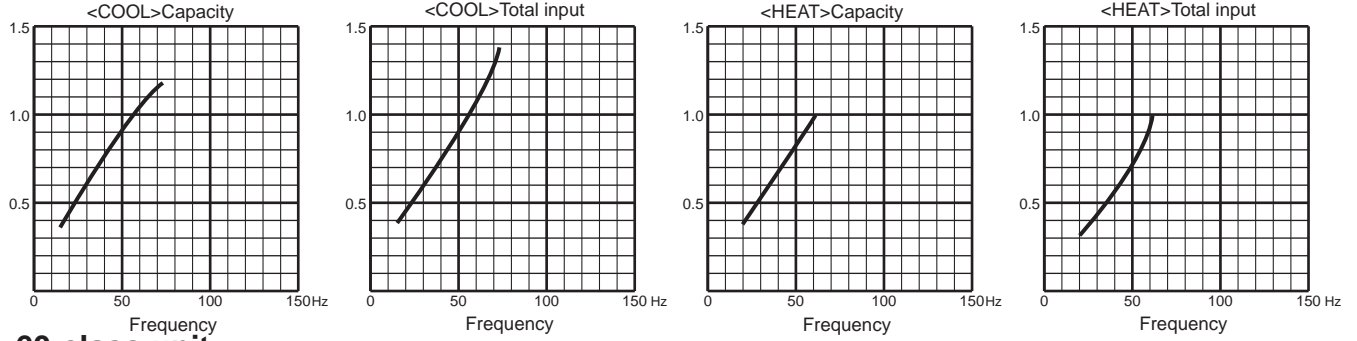

60-class unit

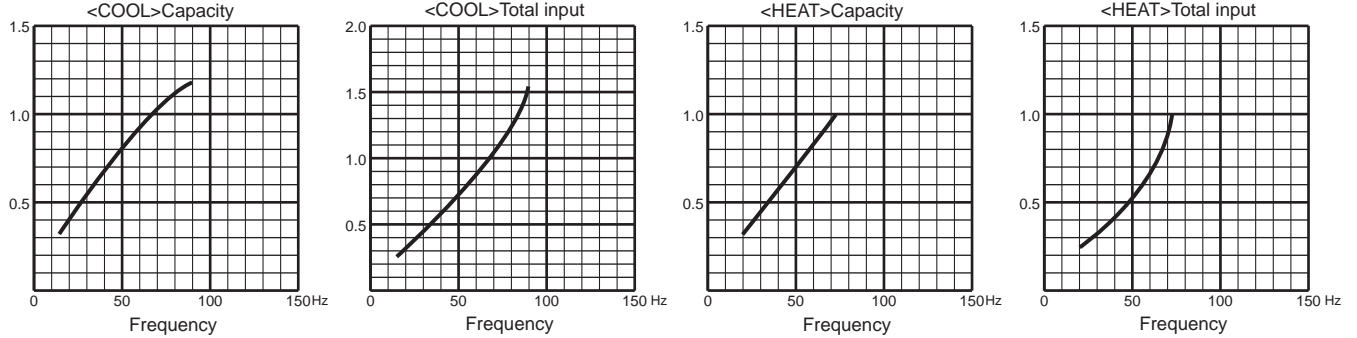

MXZ-4F83VF
15-class unit

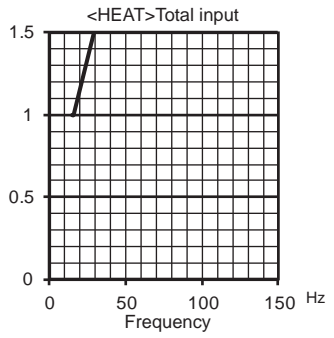
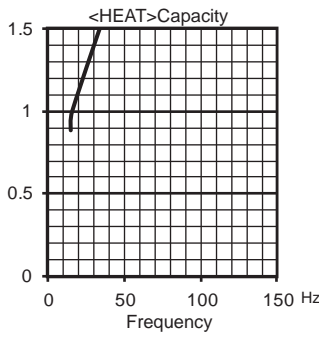
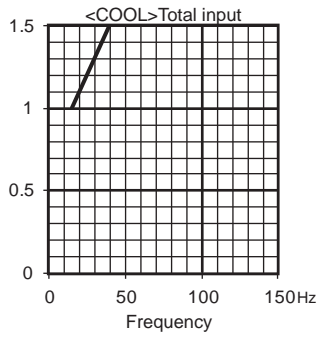
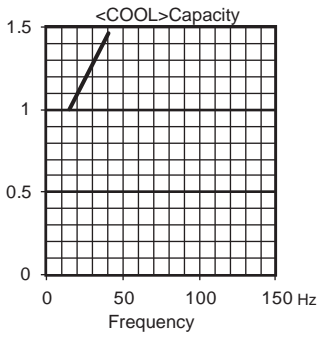

18-class unit

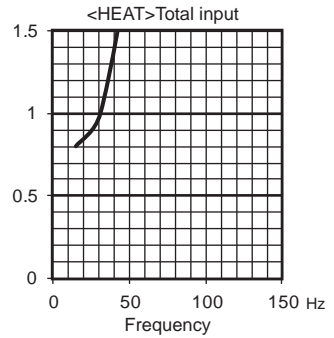
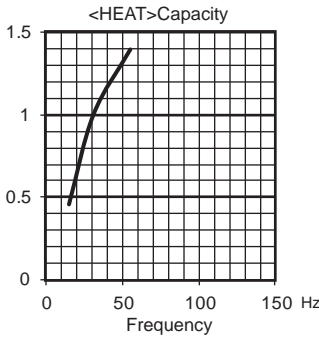
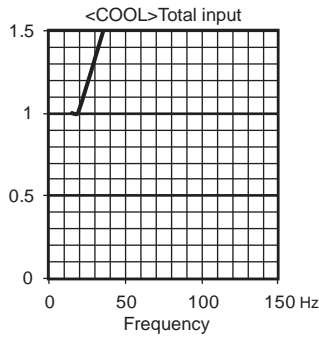
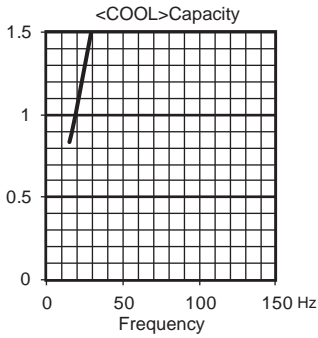

20-class unit

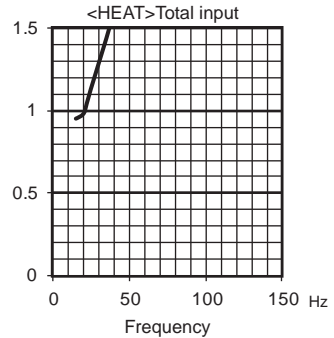
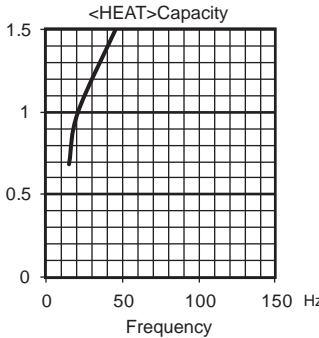
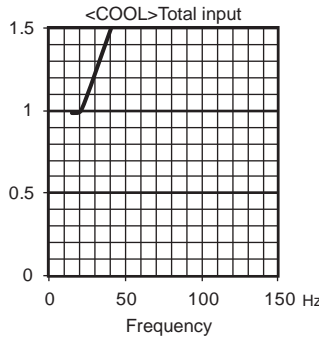
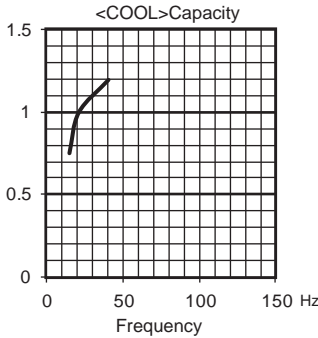

22-class unit

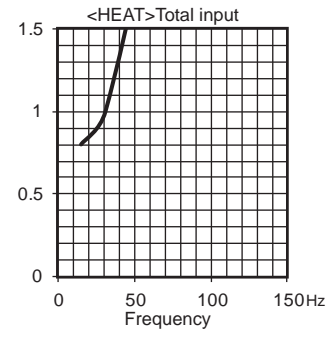
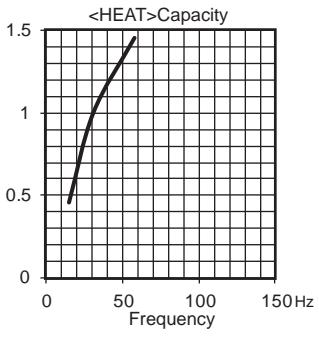
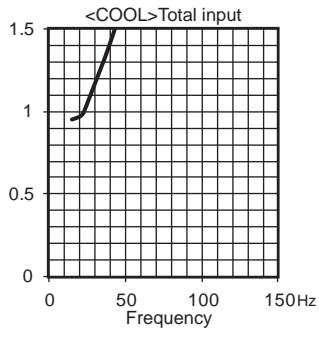
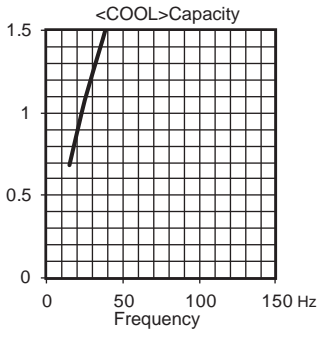

25-class unit

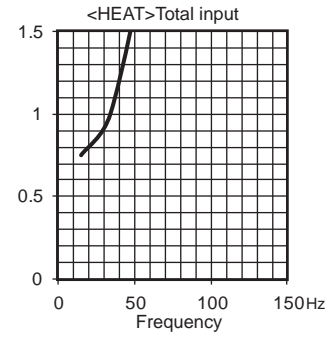
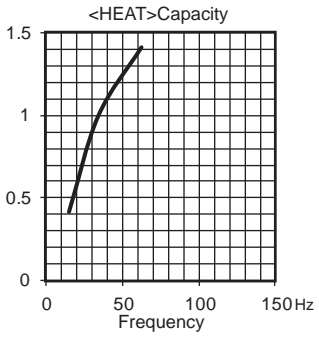
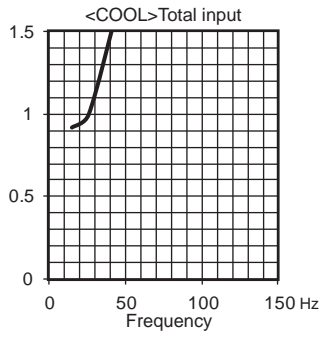
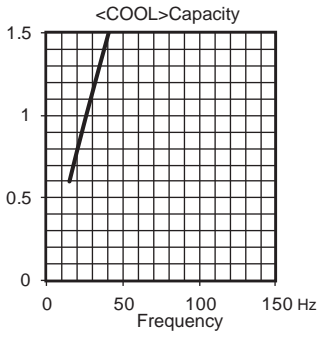

MXZ-4F83VF

35-class unit

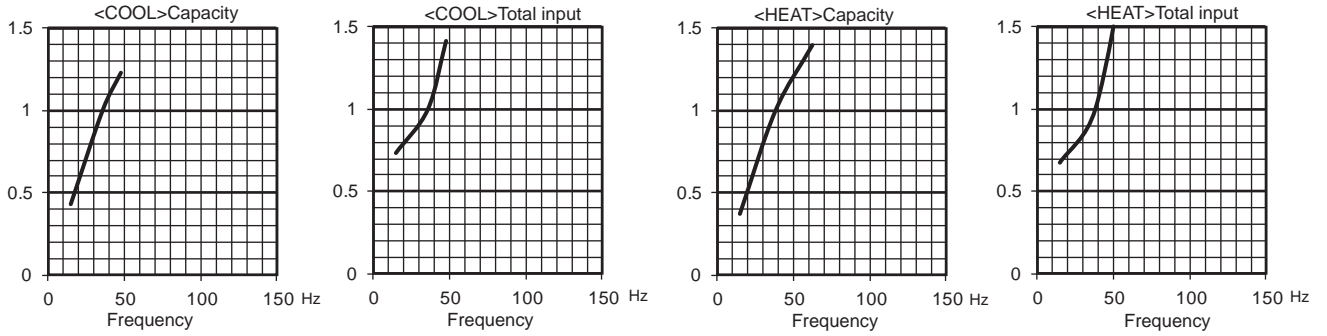

42-class unit

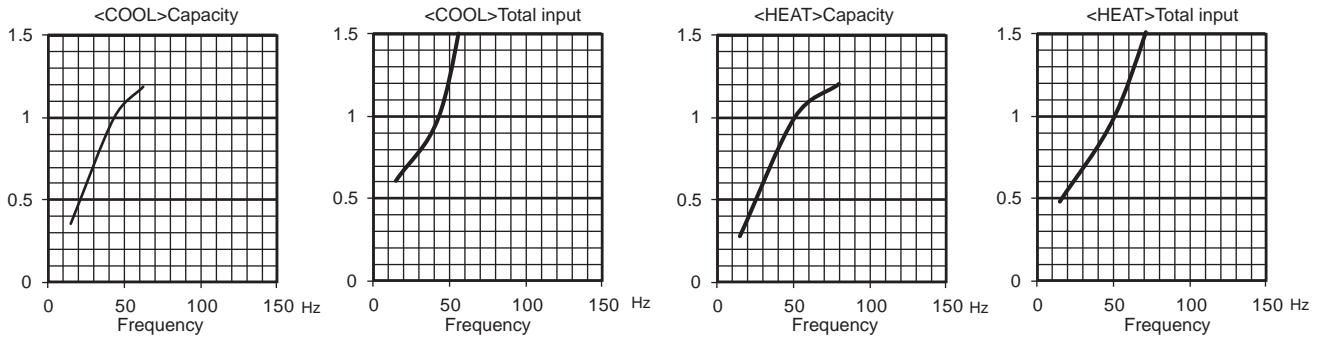

50-class unit

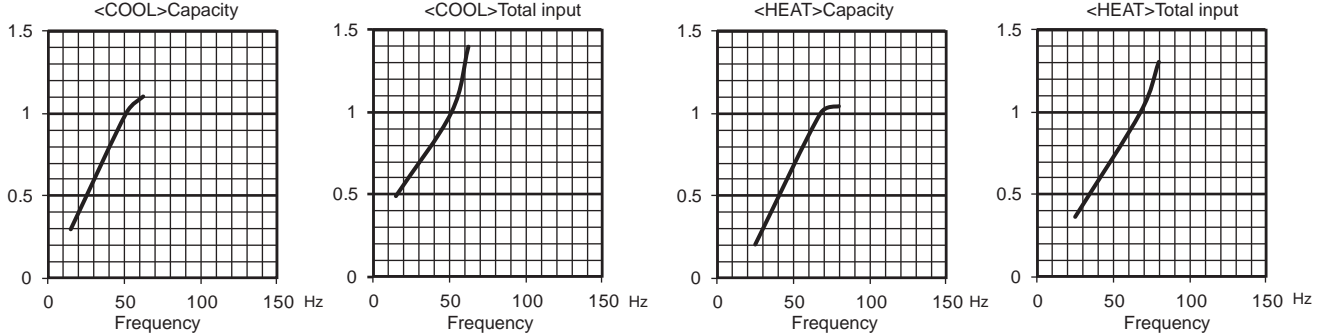

60-class unit

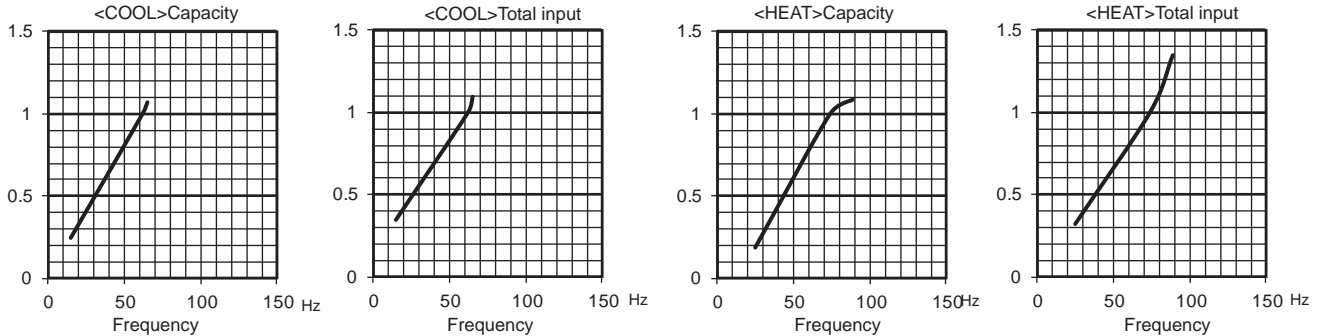

71-class unit

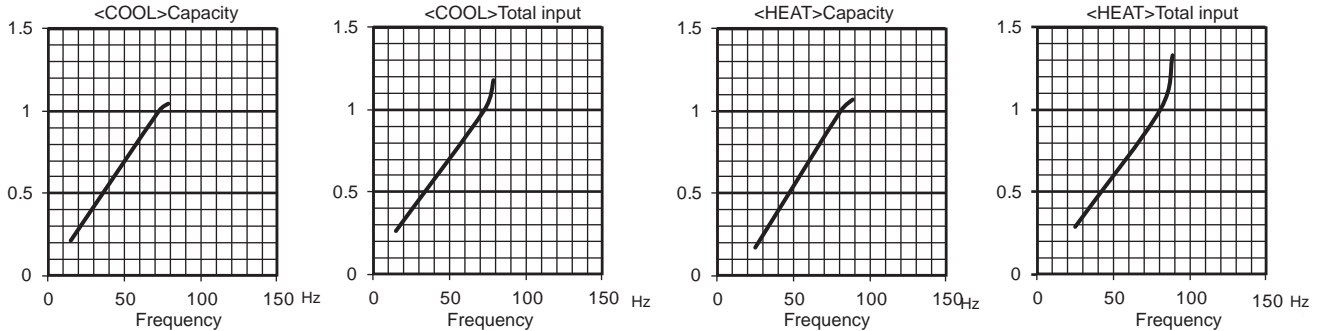

MXZ-5F102VF

15-class unit

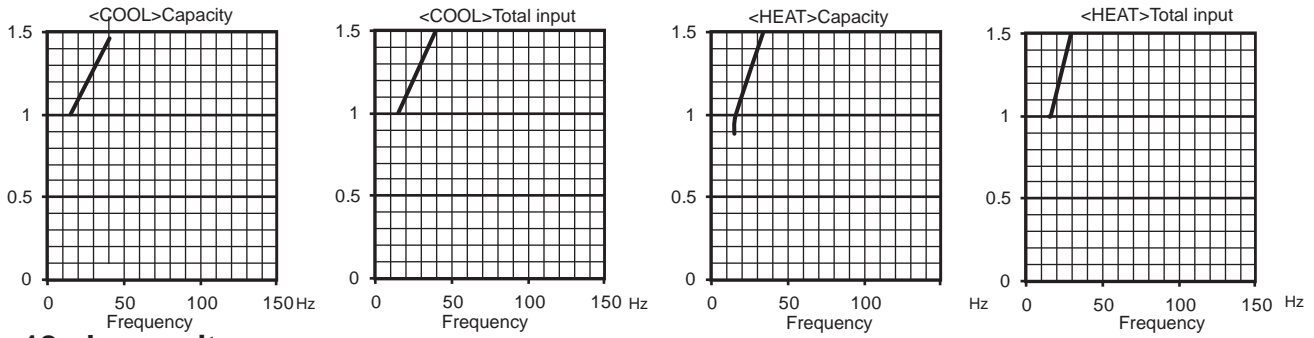

18-class unit

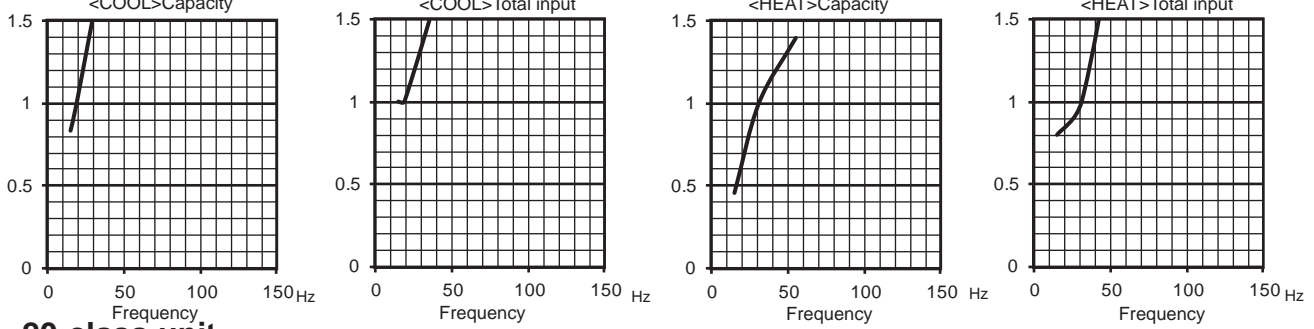

20-class unit

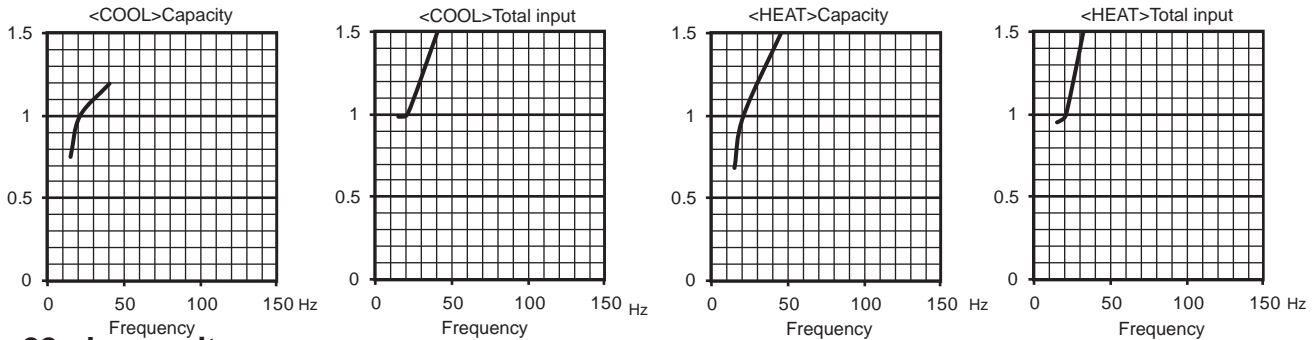

22-class unit

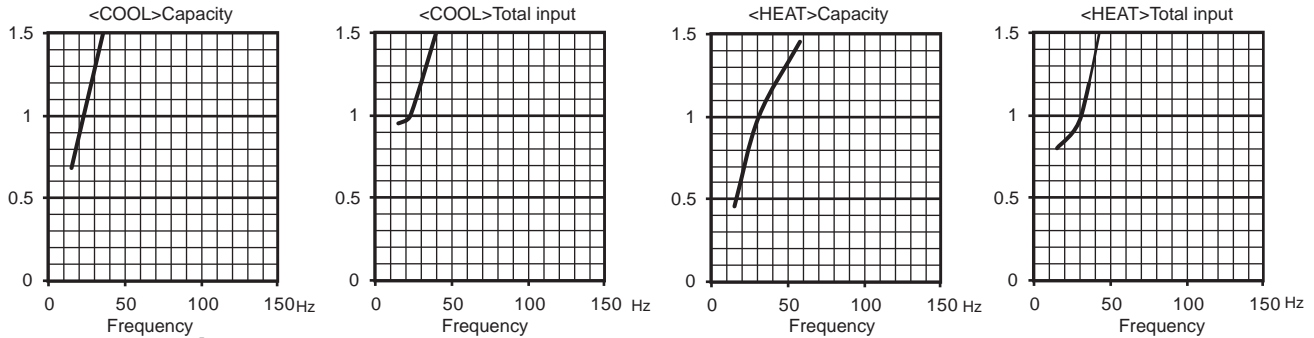

25-class unit

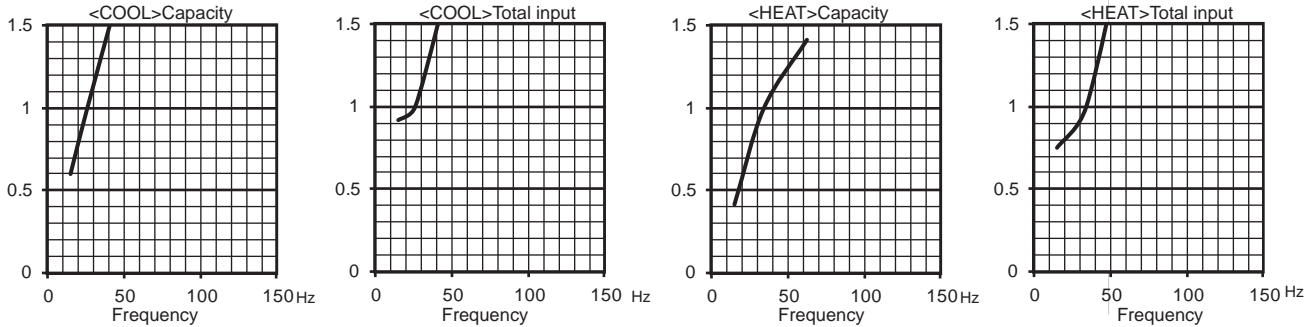

MXZ-5F102VF

35-class unit

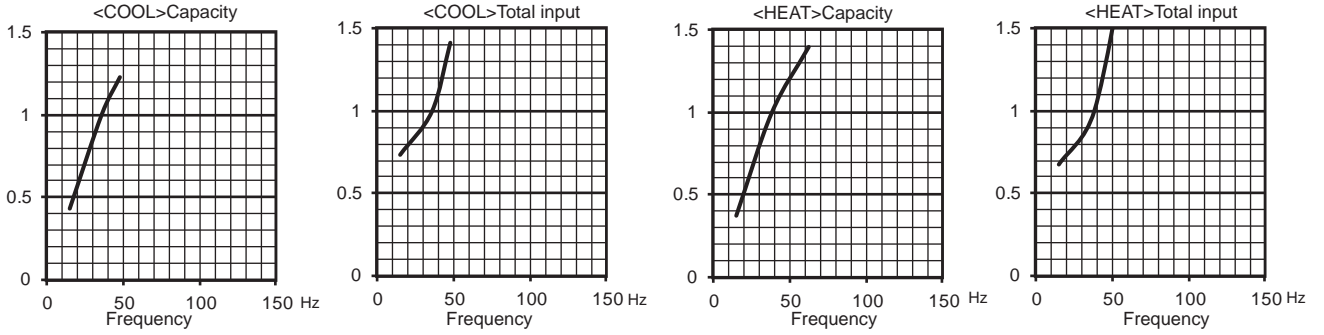

42-class unit

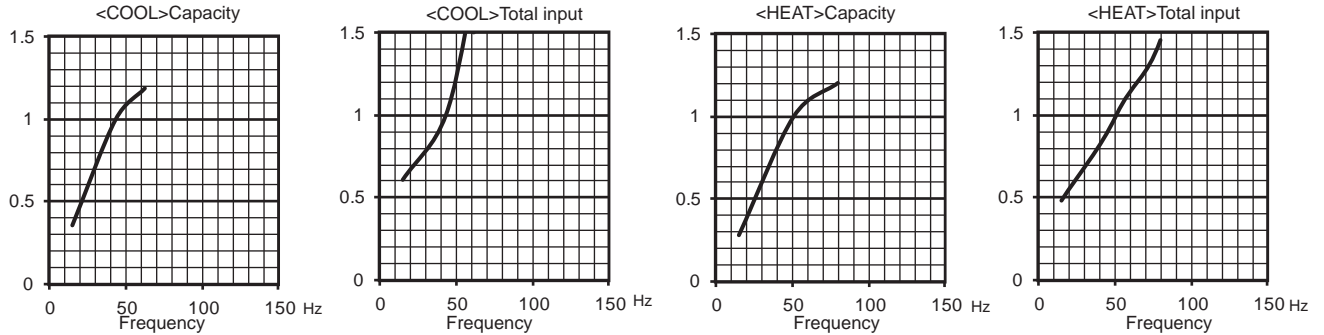

50-class unit

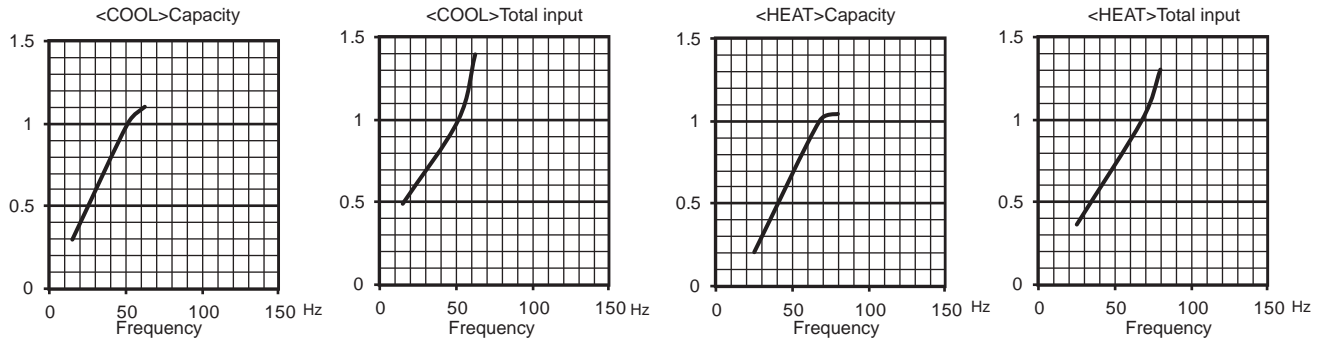

60-class unit

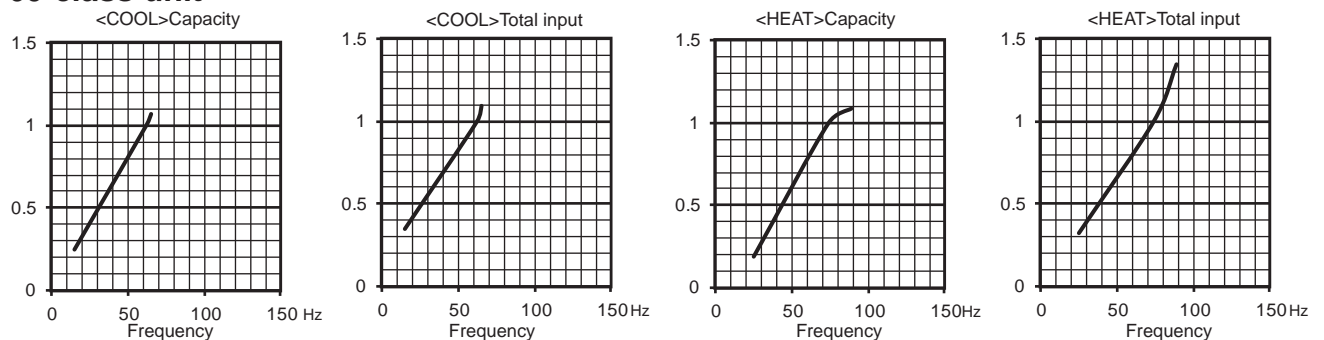

71-class unit

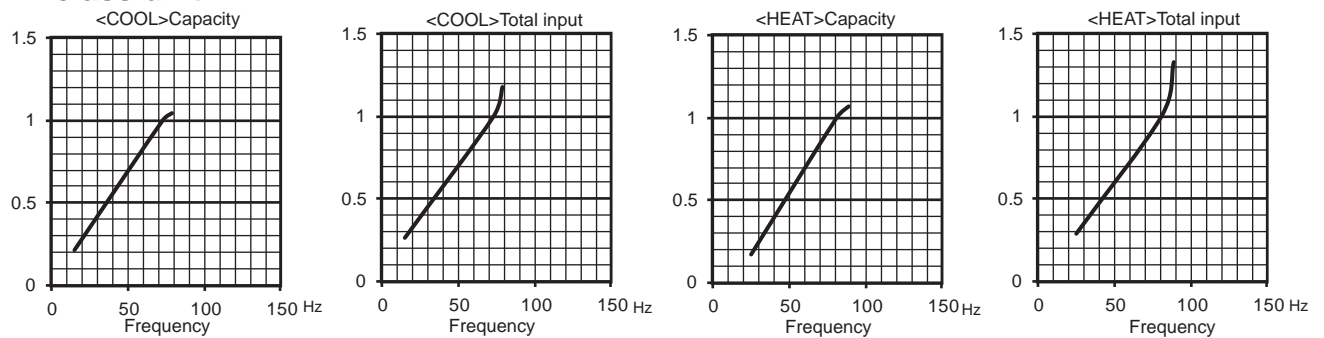

MXZ-6F122VF

15-class unit

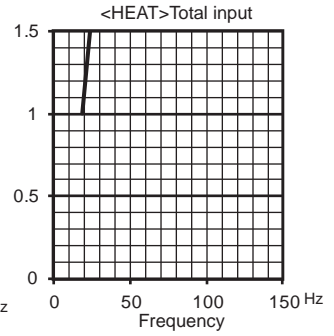
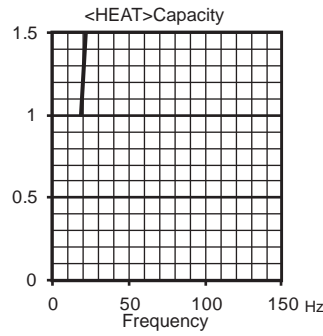
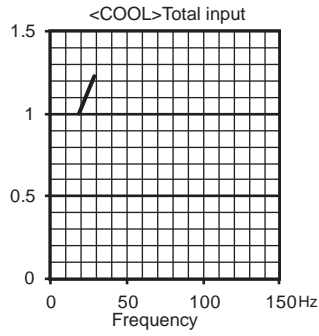
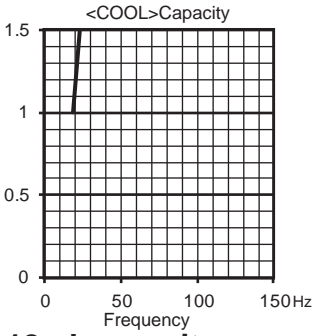

18-class unit

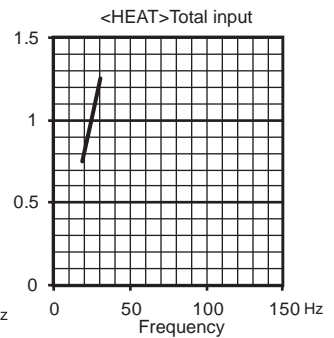
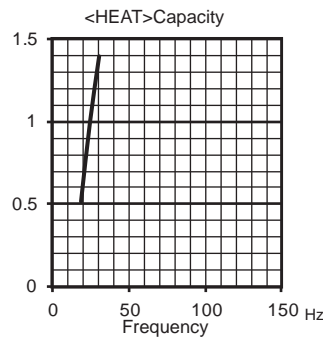
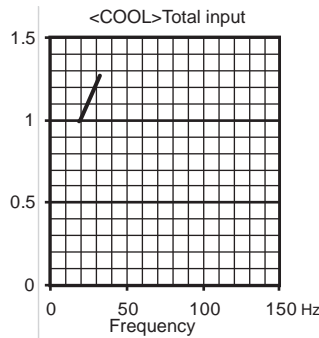
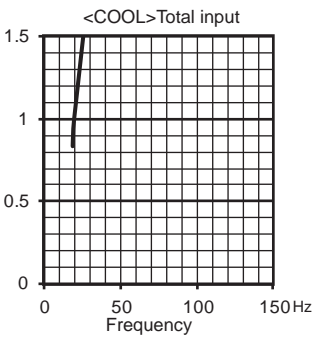

20-class unit

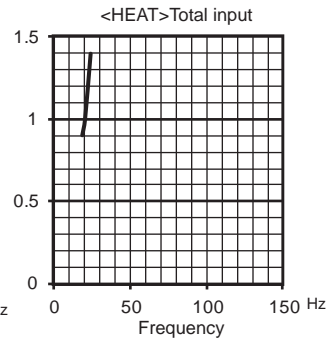
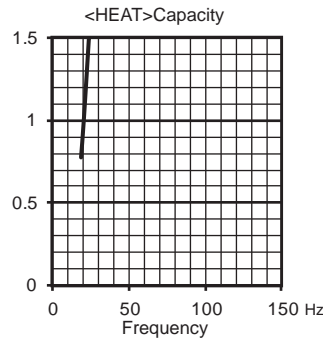
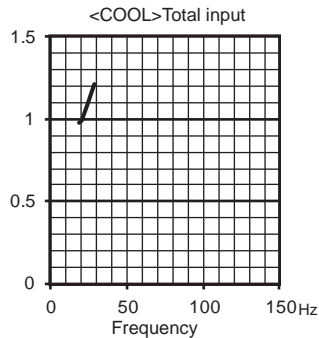
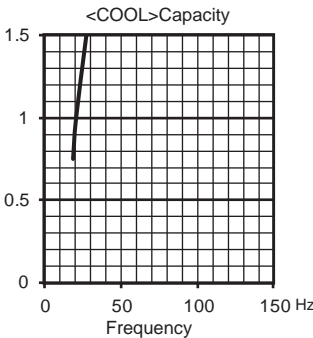

22-class unit

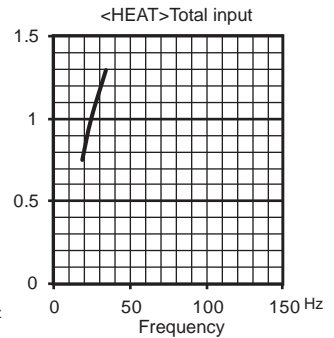
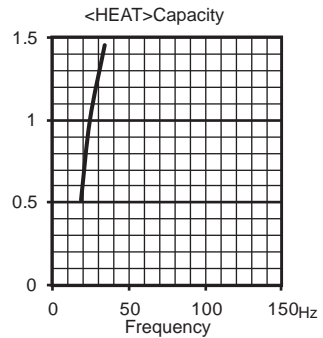
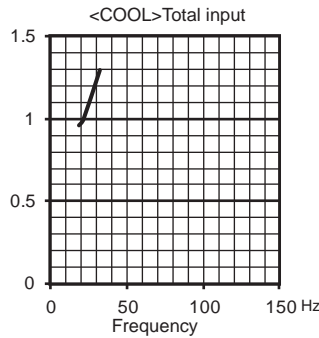
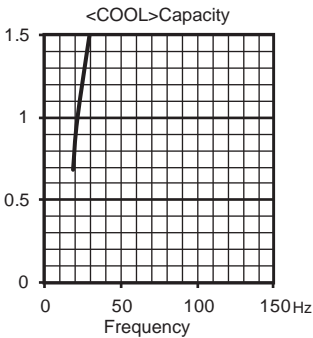

25-class unit

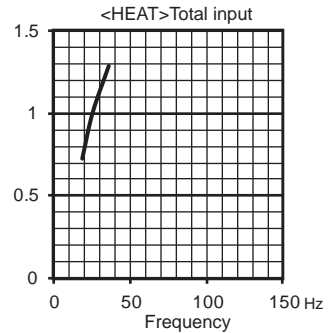
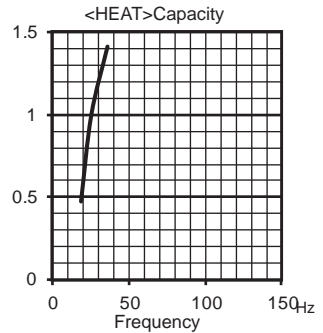
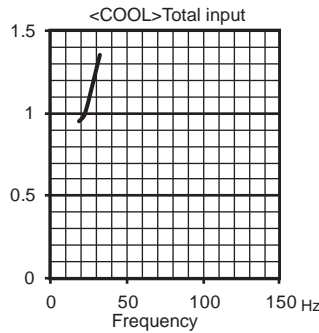
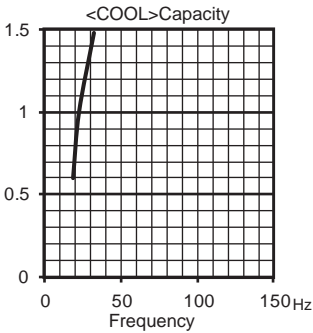

MXZ-6F122VF
35-class unit

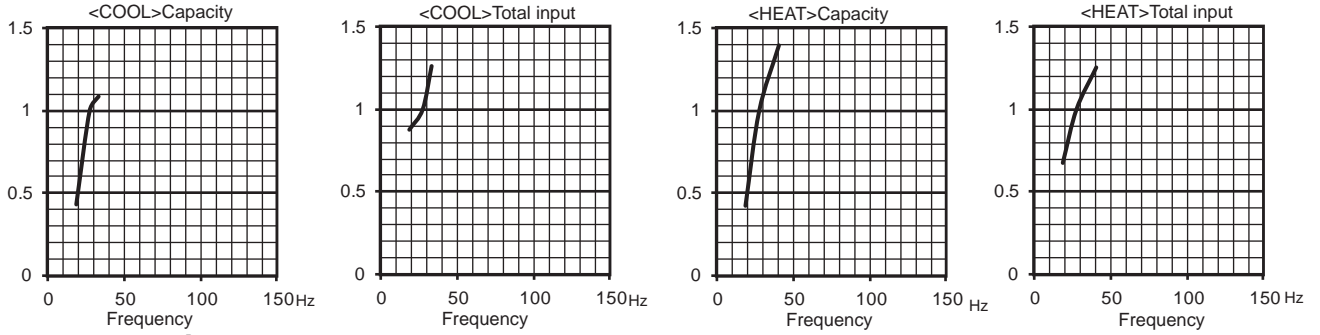

42-class unit

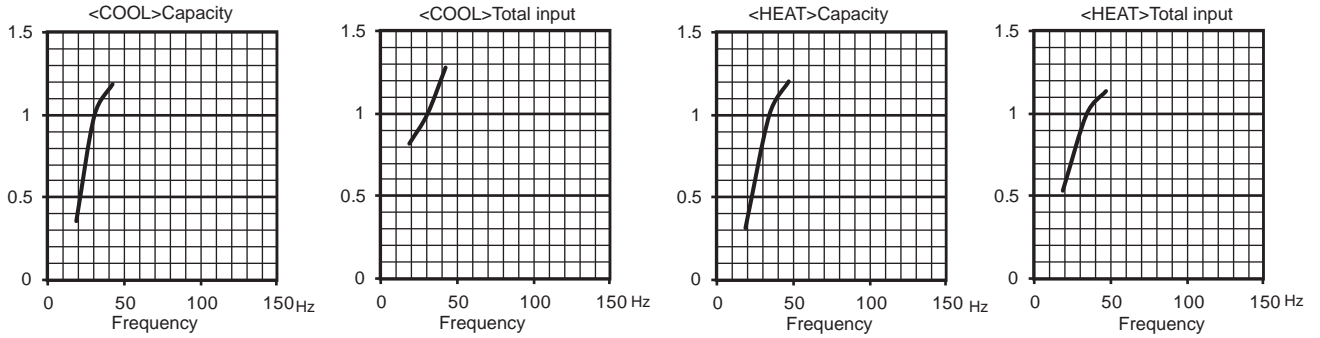

50-class unit

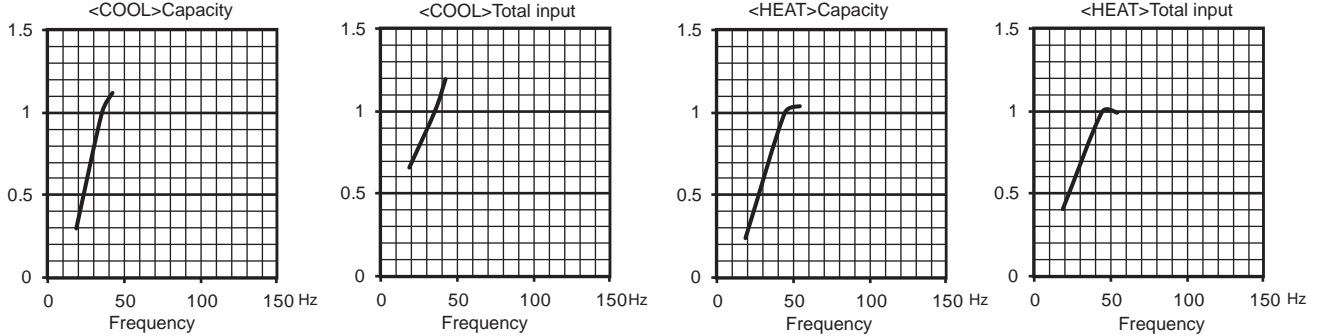

60-class unit

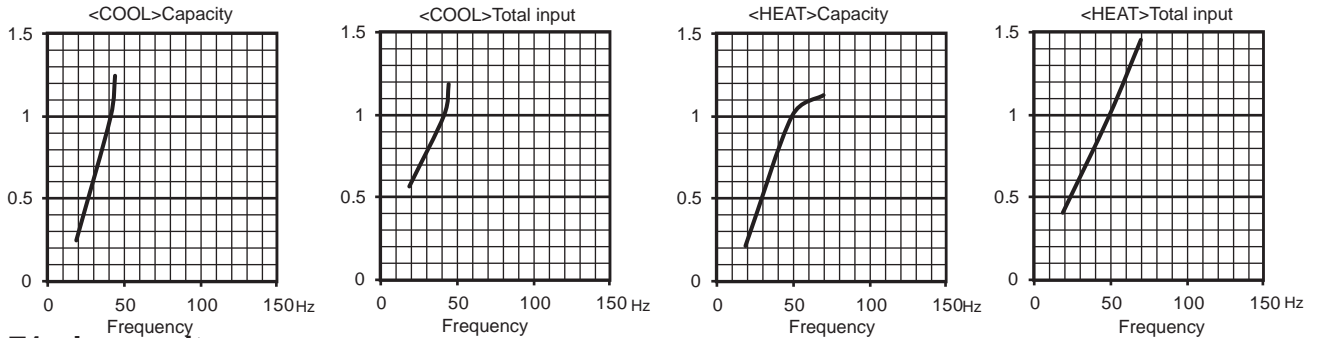

71-class unit

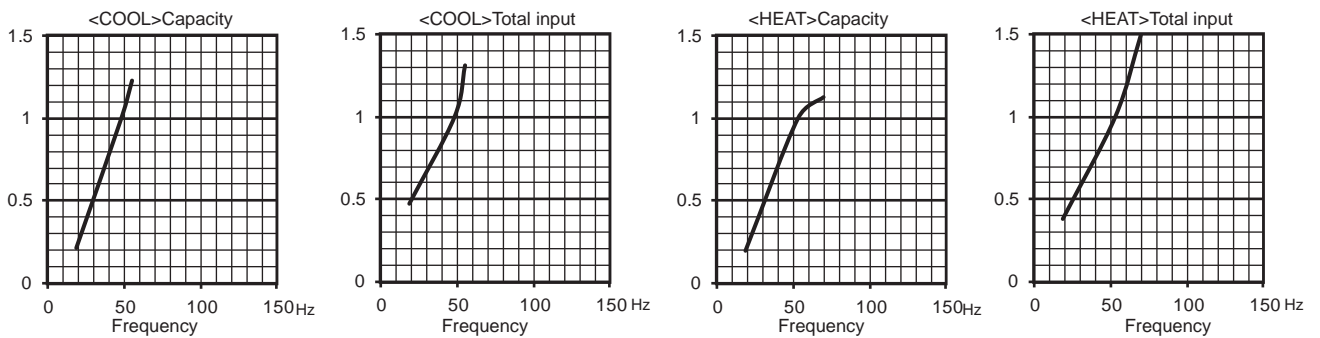

MXZ-2F53VFHZ

15-class unit

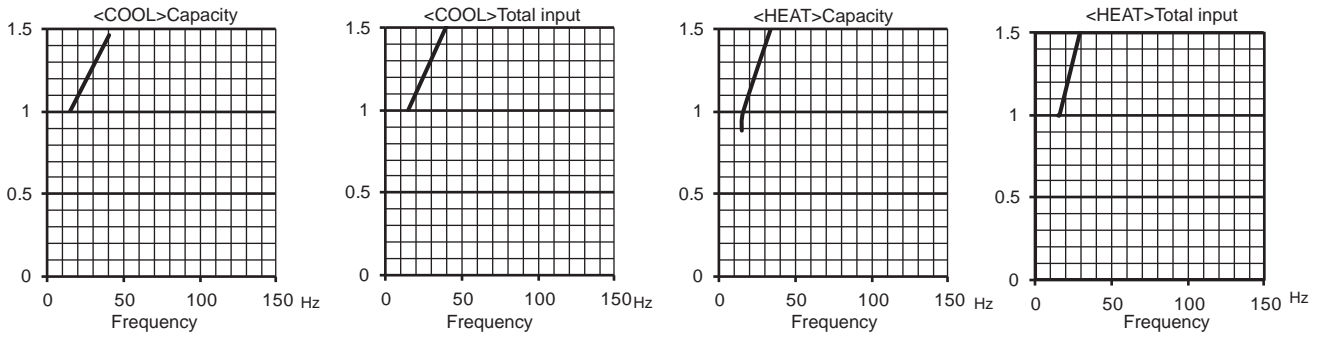

18-class unit

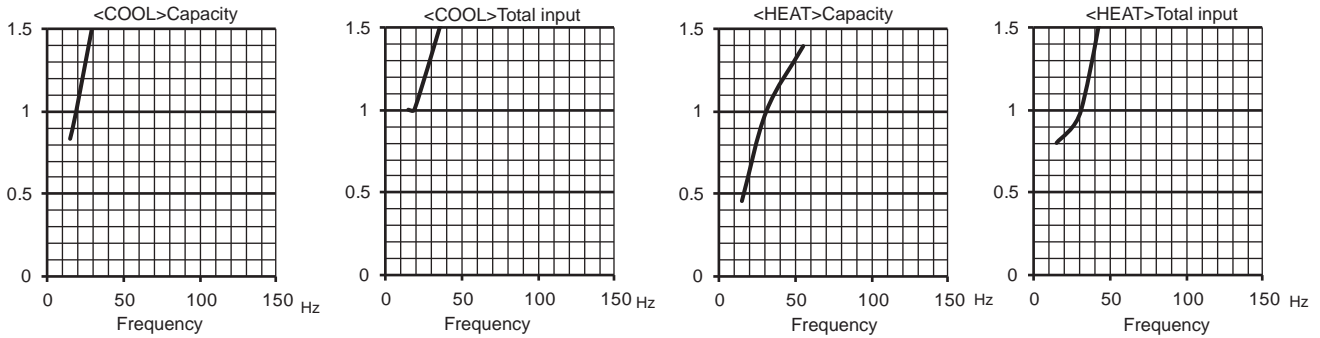

20-class unit

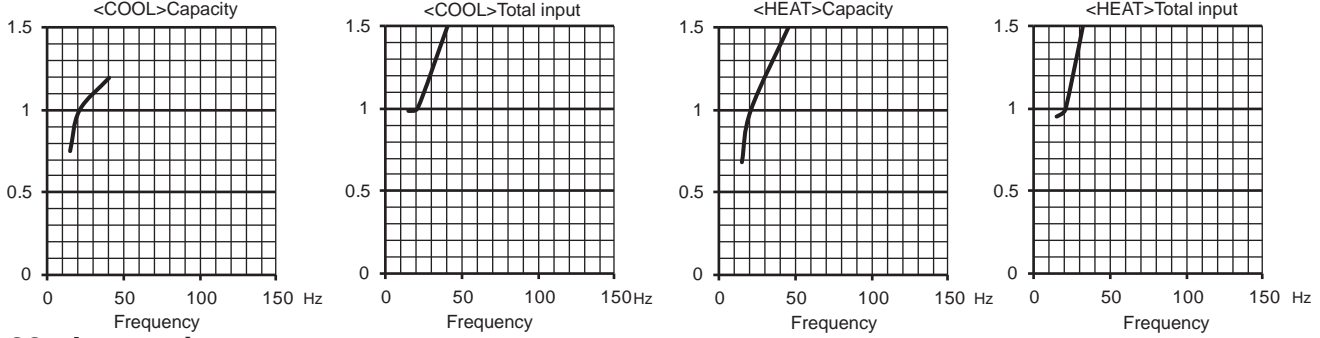

22-class unit

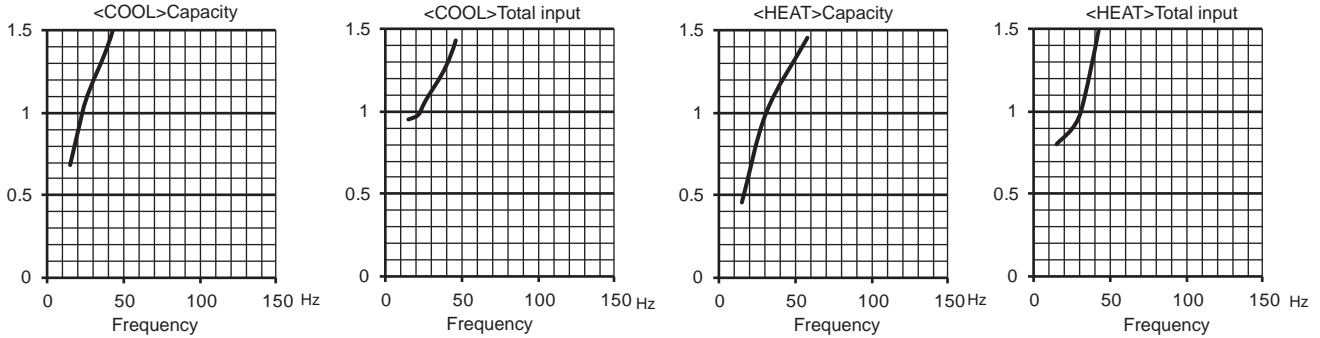

25-class unit

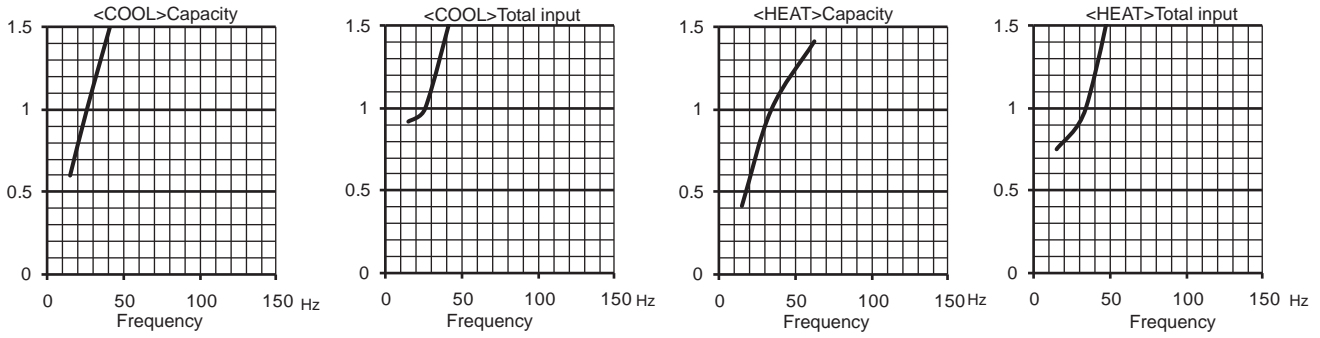



MXZ-2F53VFHZ

35-class unit

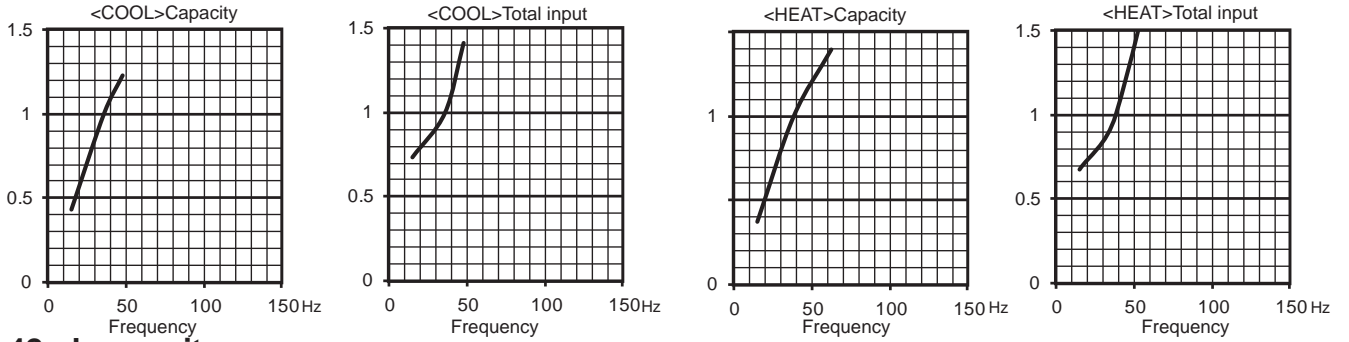

42-class unit

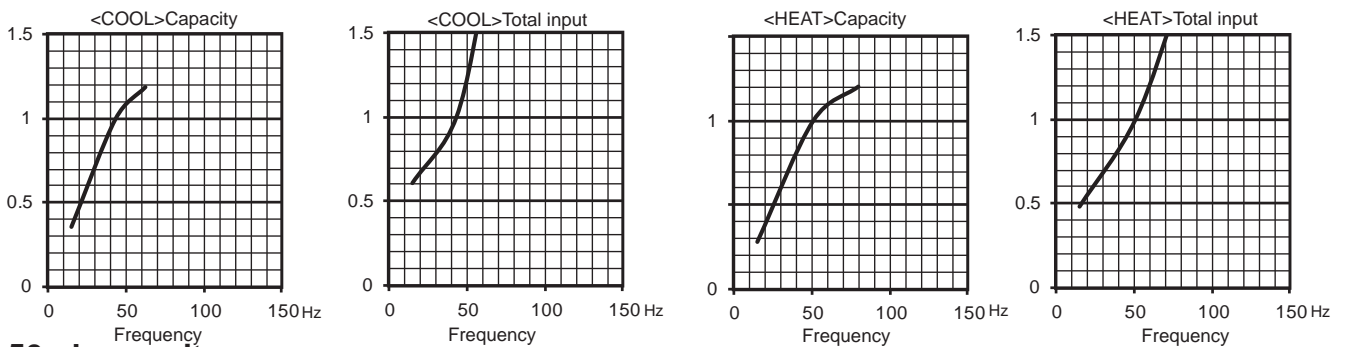

50-class unit

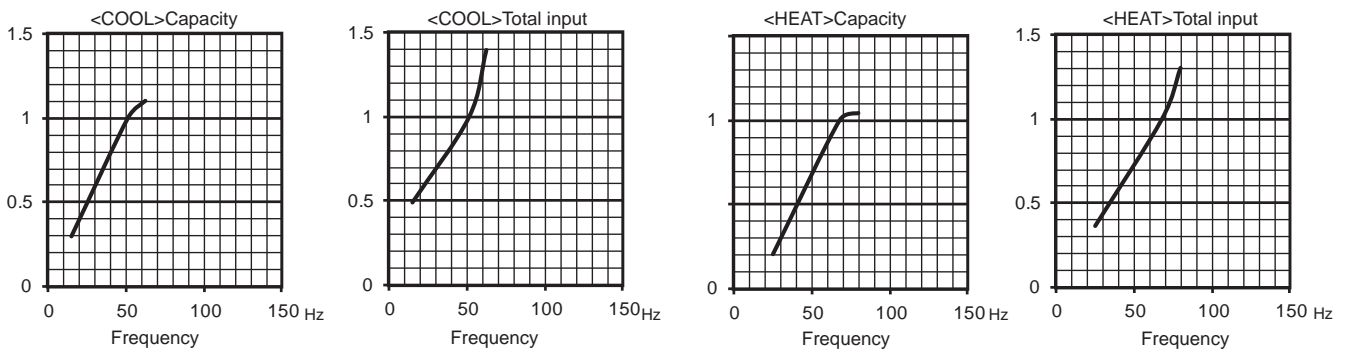

MXZ-4F83VFHZ

35-class unit

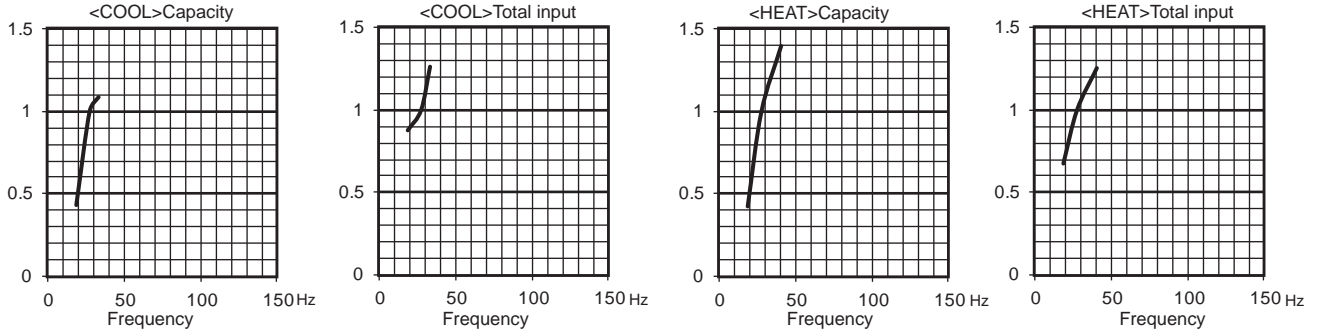

42-class unit

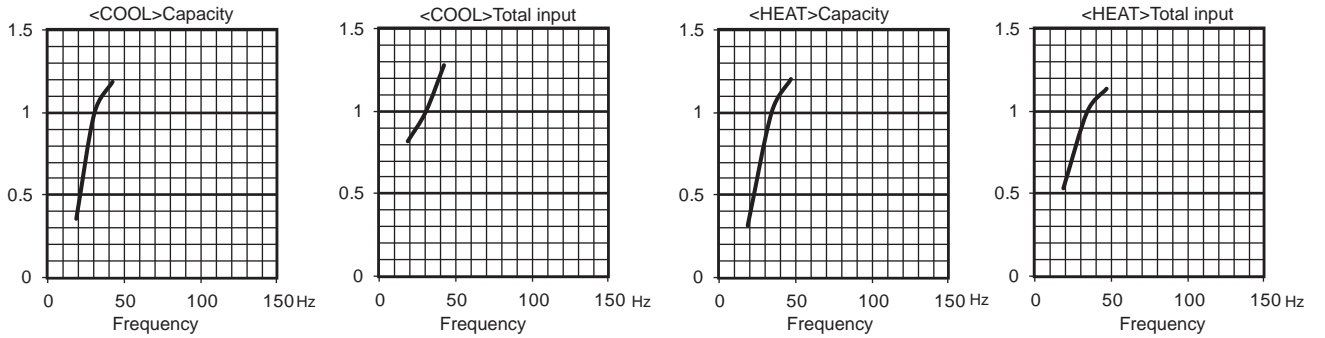

50-class unit

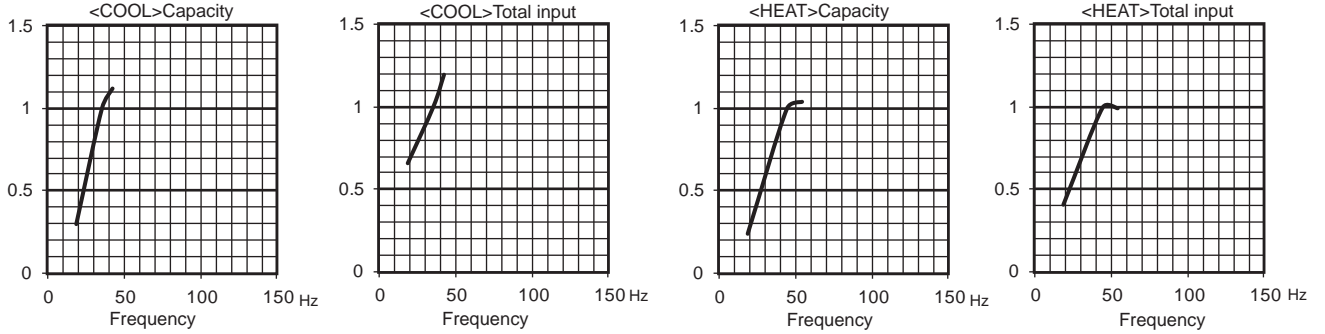

60-class unit

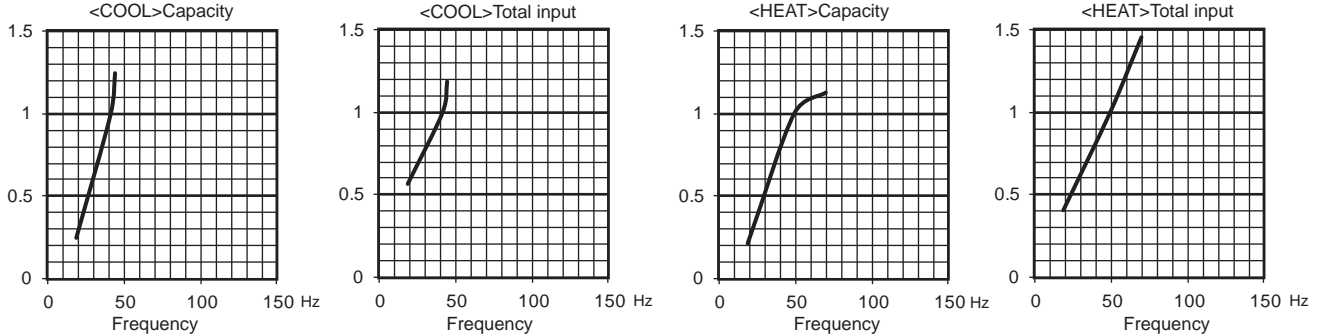

71-class unit

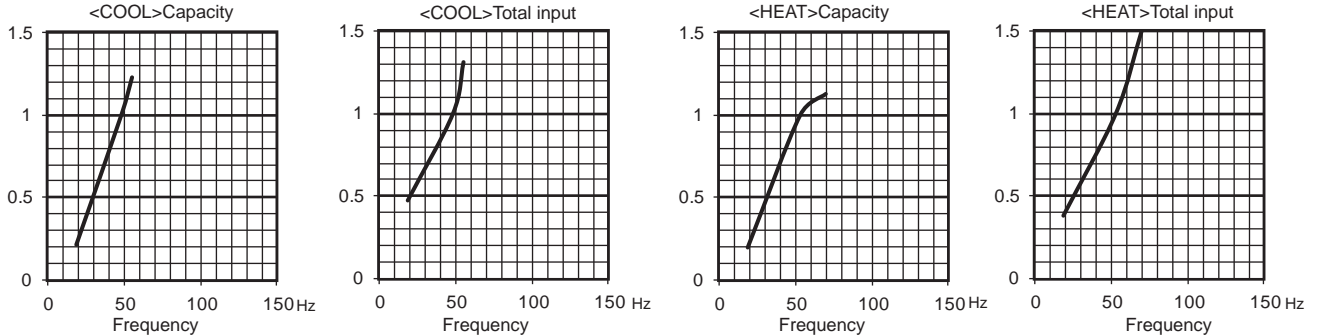

9-3. HOW TO OPERATE FIXED-FREQUENCY OPERATION <Test run operation>

1. Press EMERGENCY OPERATION switch to start COOL or HEAT mode (COOL : Press once, HEAT : Press twice).
2. Test run operation starts and continues to operate for 30 minutes.
3. Compressor operates at rated frequency.
4. Indoor fan operates at High speed.
5. After 30 minutes, test run operation finishes and EMERGENCY OPERATION starts (Operation frequency of compressor varies).
6. To cancel test run operation or EMERGENCY OPERATION, press EMERGENCY OPERATION switch or any button on remote controller.

9-4. OUTDOOR LOW PRESSURE AND OUTDOOR UNIT CURRENT CURVE (single operation)

NOTE: The unit of pressure has been changed to MPa on the international system of units (SI unit system).
The conversion factor is : **1 (MPa [Gauge]) = 10.2 (kgf/cm² [Gauge])**

(1) COOL operation

- ① Both indoor and outdoor units are under the same temperature/humidity condition.
- ② Operation : TEST RUN OPERATION (Refer to 9-3.)

Dry-bulb temperature (°C)	Relative humidity (%)
20	50
25	60
30	70

MXZ-2F33VF MXZ-2F33VF2 MXZ-2F33VF3

15-class unit

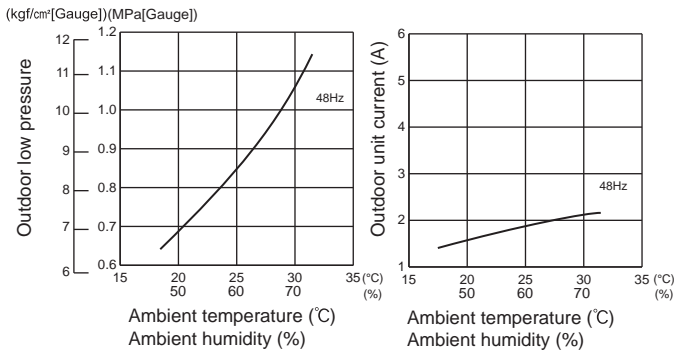

18-class unit

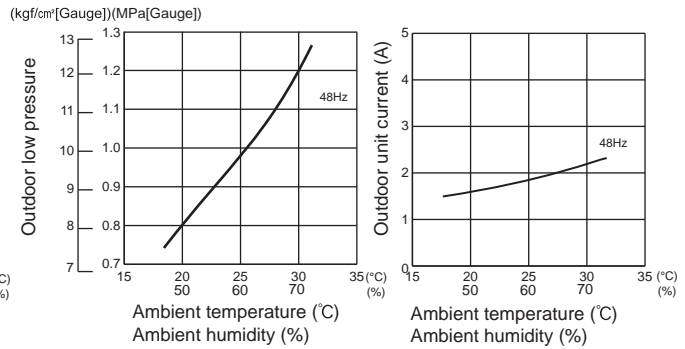

20-class unit

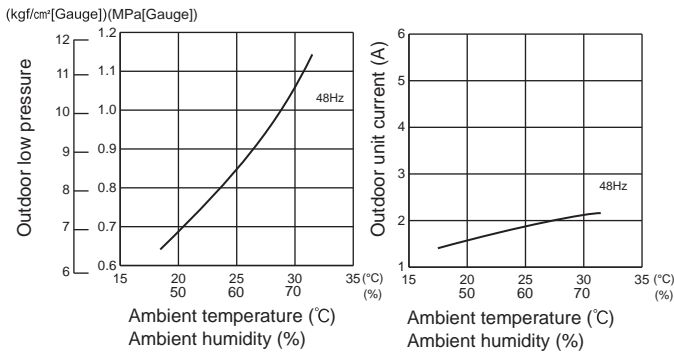

22-class unit

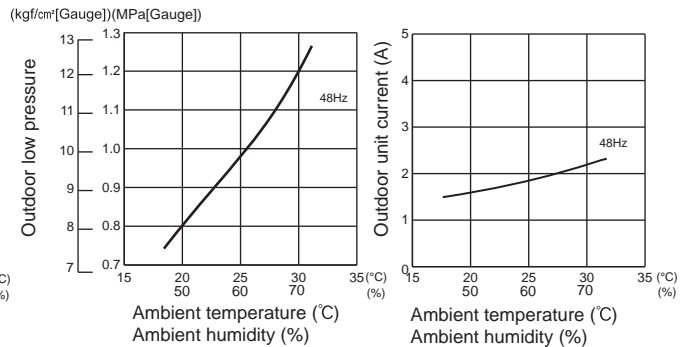

25-class unit

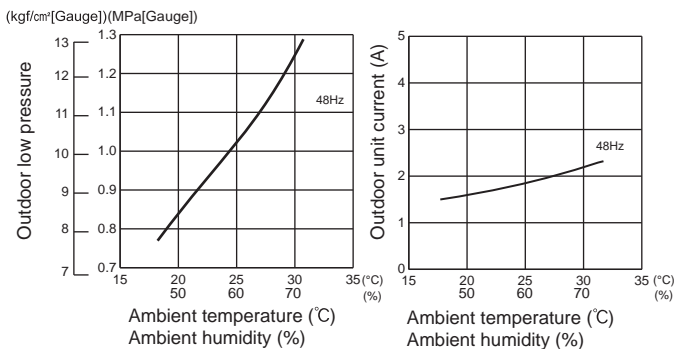

MXZ-2F42VF MXZ-2F42VF2 MXZ-2F42VF3

15-class unit

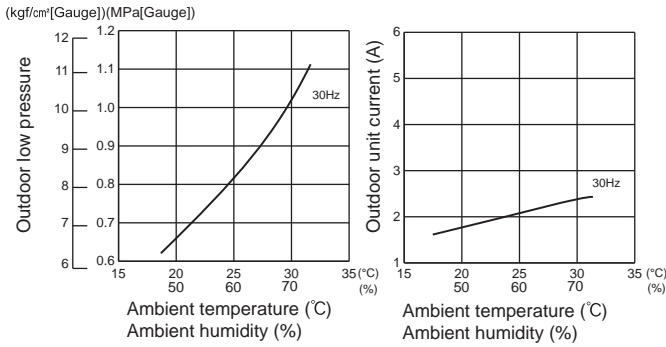

18-class unit

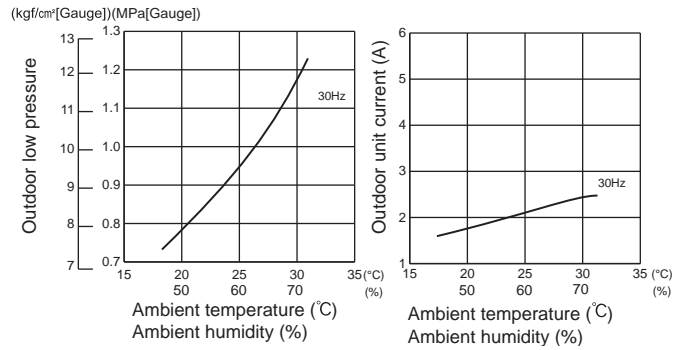

20-class unit

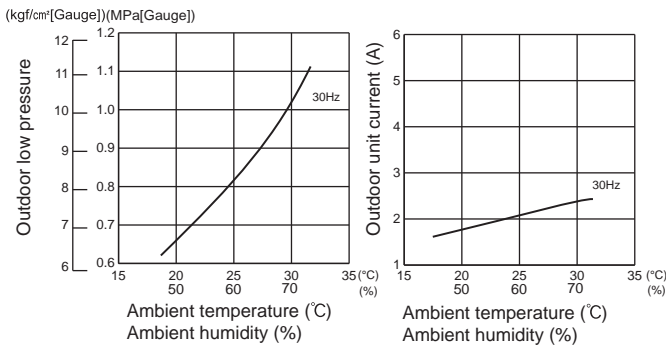

22-class unit

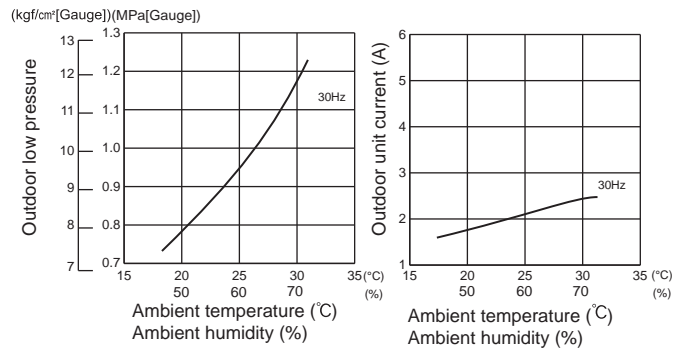

25-class unit

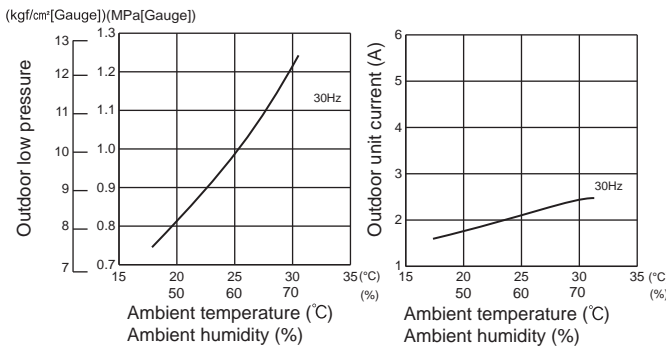

35-class unit

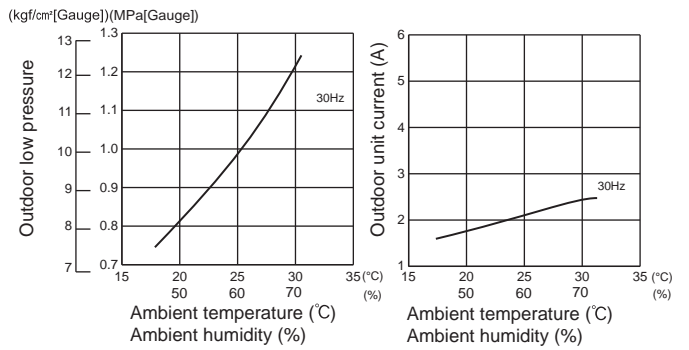

MXZ-3F68VF MXZ-3F68VF2 MXZ-3F68VF3 MXZ-4F72VF MXZ-4F72VF2 MXZ-4F72VF3

60-class unit

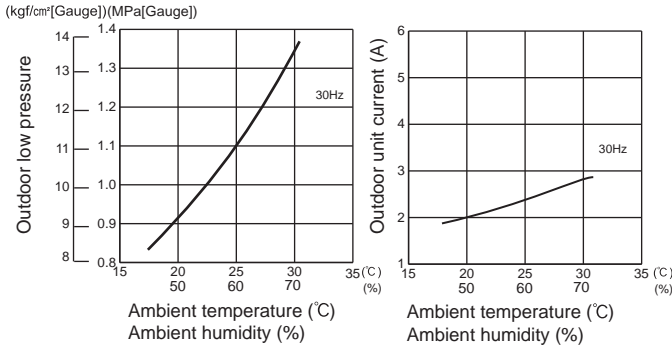

MXZ-4F80VF2 MXZ-4F80VF3

15-class unit

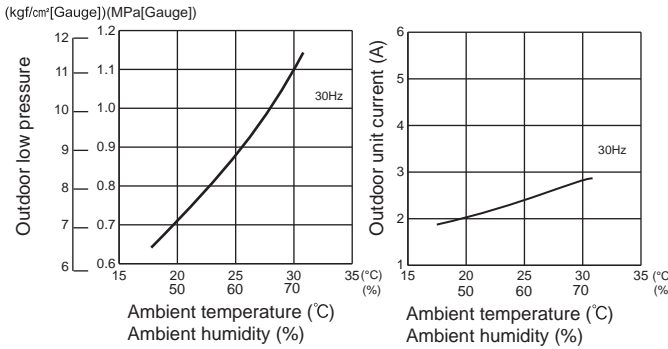

18-class unit

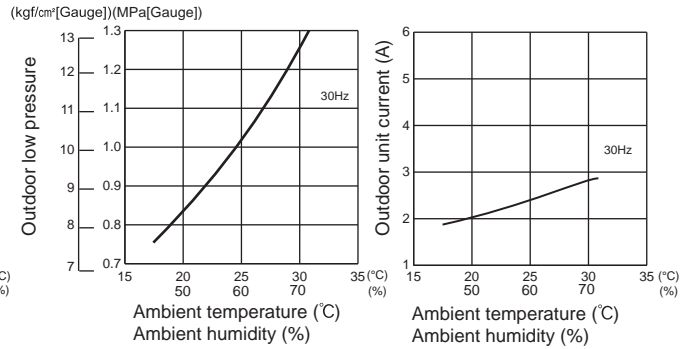

20-class unit

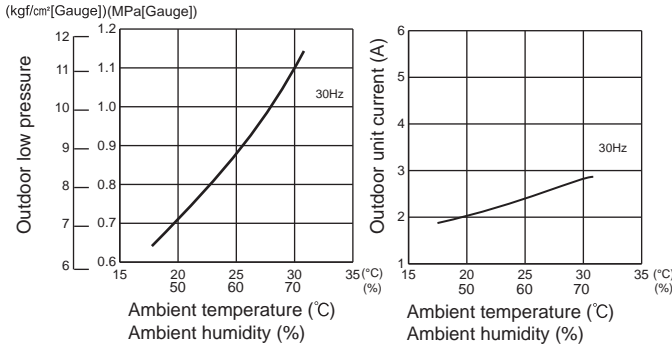

22-class unit

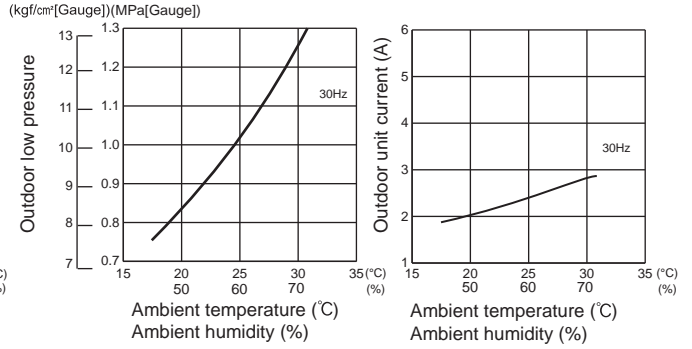

25-class unit

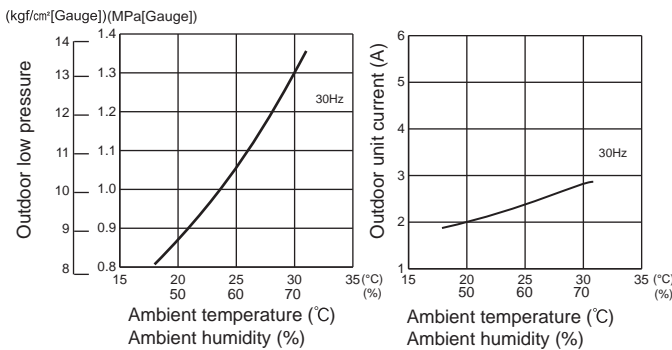

35-class unit

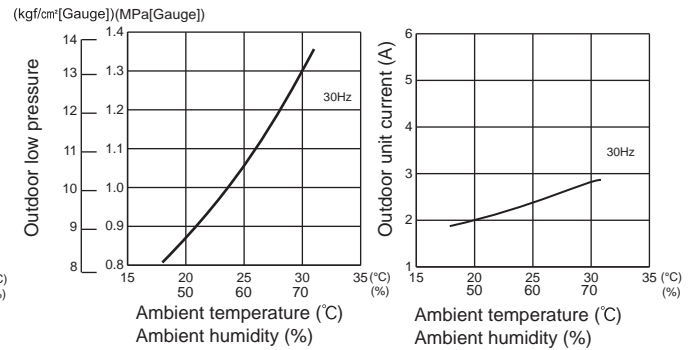

MXZ-4F80VF2 MXZ-4F80VF3

42-class unit

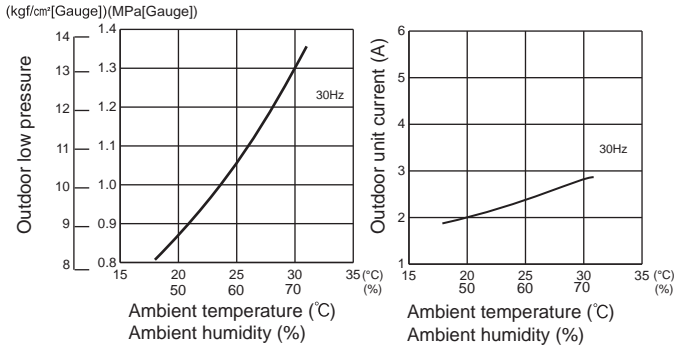

50-class unit

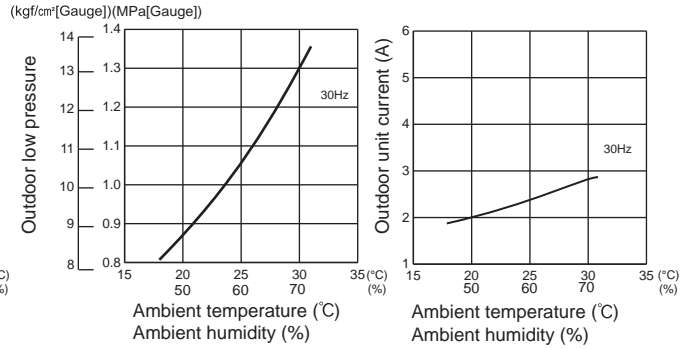

60-class unit

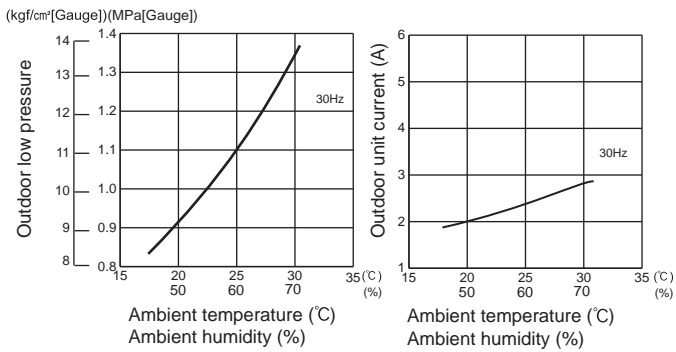

MXZ-4F83VF

15-class unit

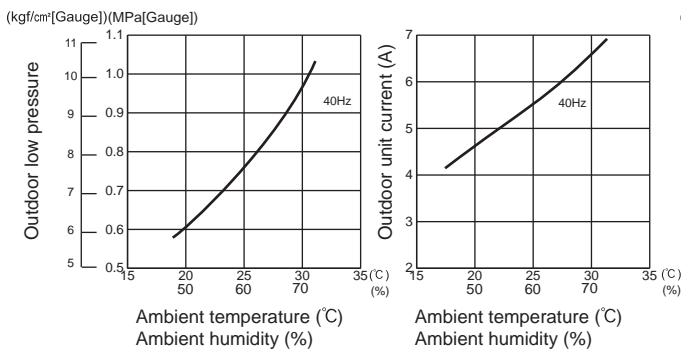

18-class unit

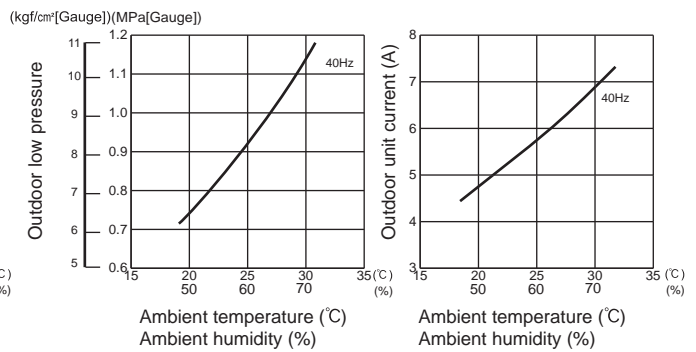

20-class unit

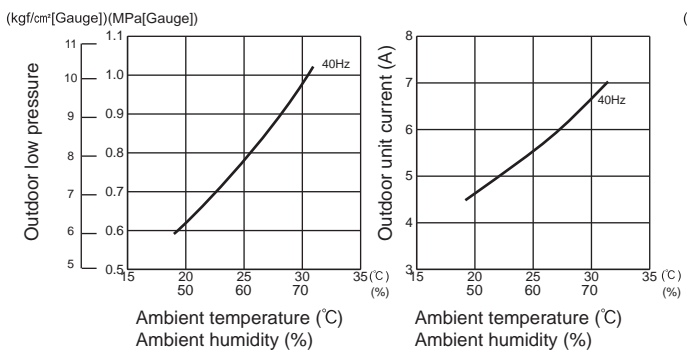

22-class unit

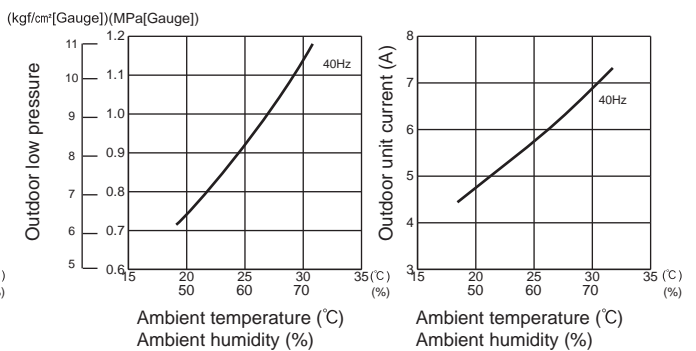

60-class unit

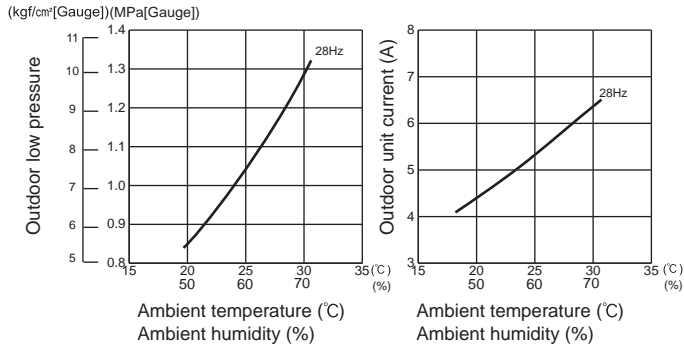

71-class unit

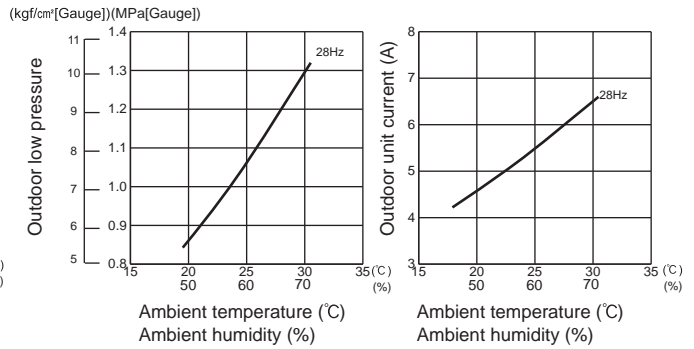

MXZ-2F53VFHZ

15-class unit

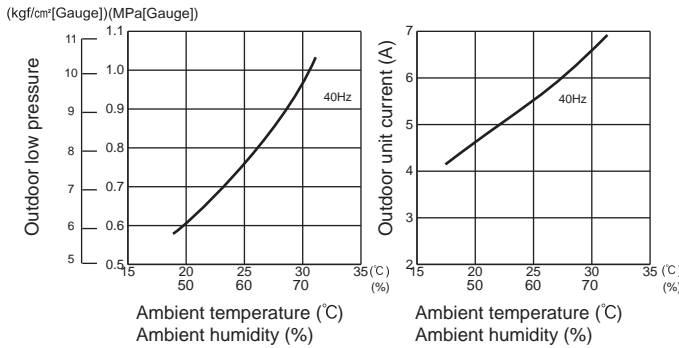

18-class unit

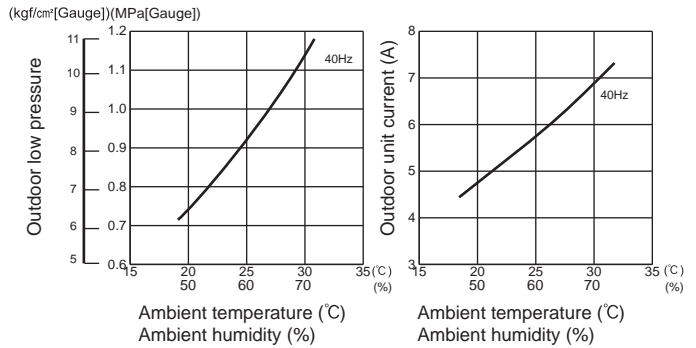

20-class unit

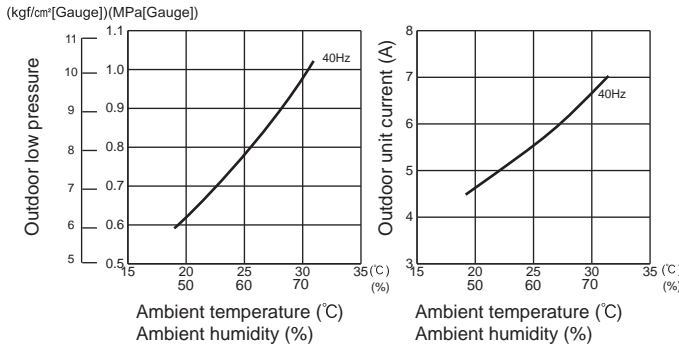

22-class unit

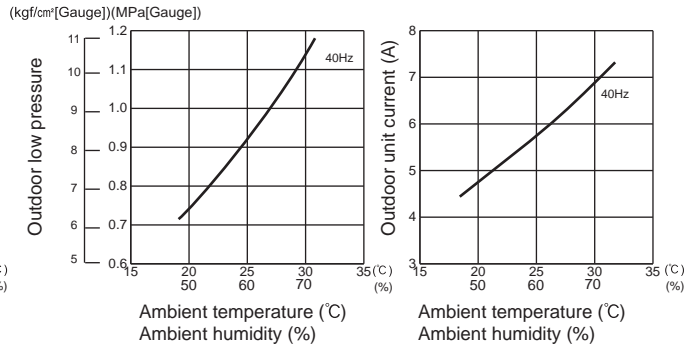

25-class unit

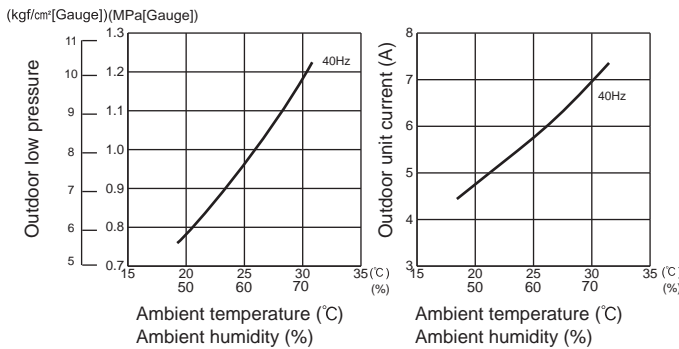

35-class unit

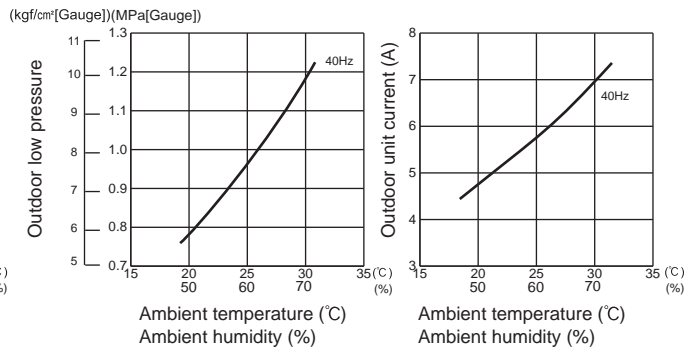

MXZ-2F53VFHZ

42-class unit

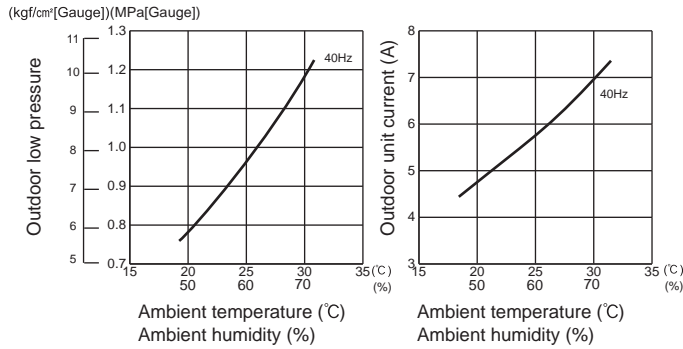

50-class unit

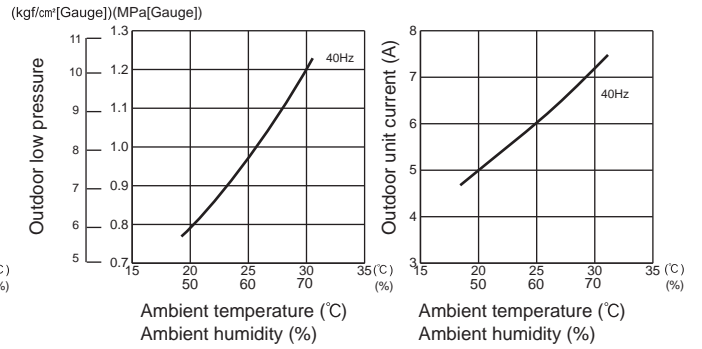

MXZ-4F83VFHZ

15-class unit

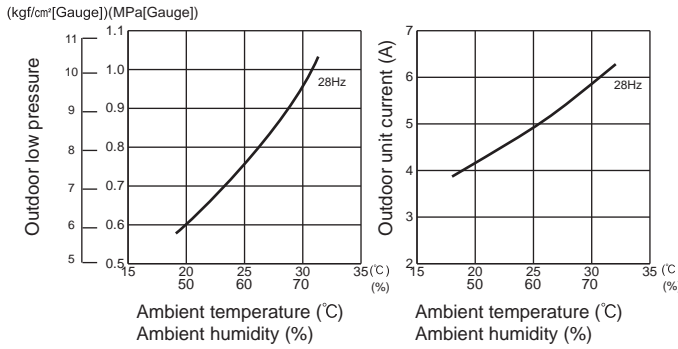

18-class unit

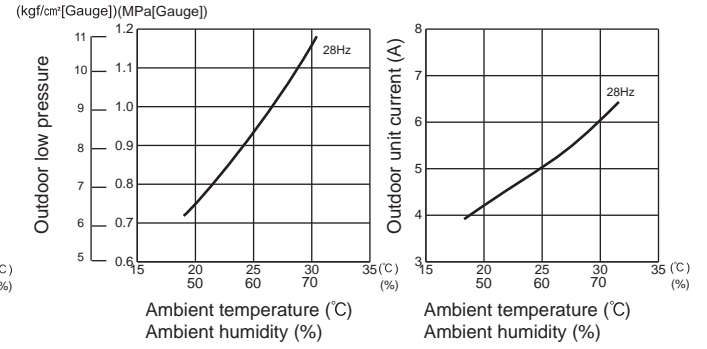

20-class unit

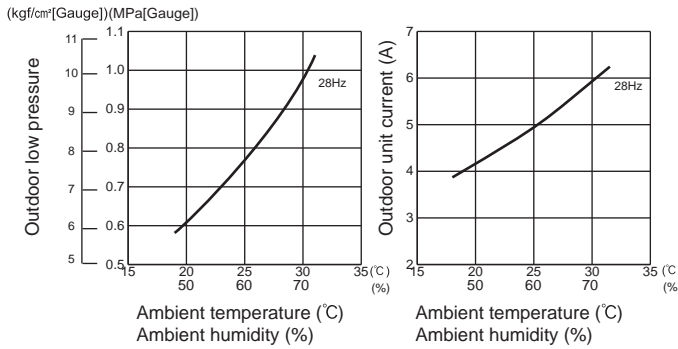

22-class unit

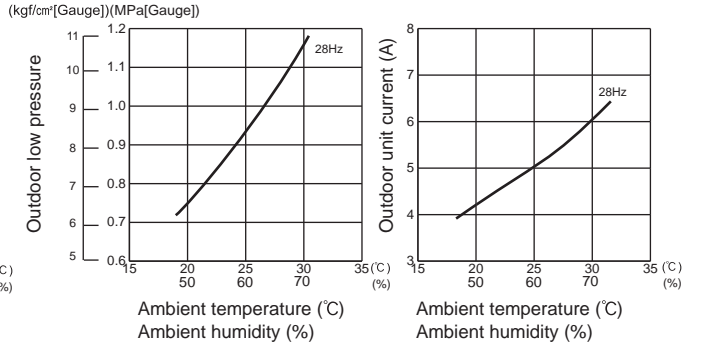

25-class unit

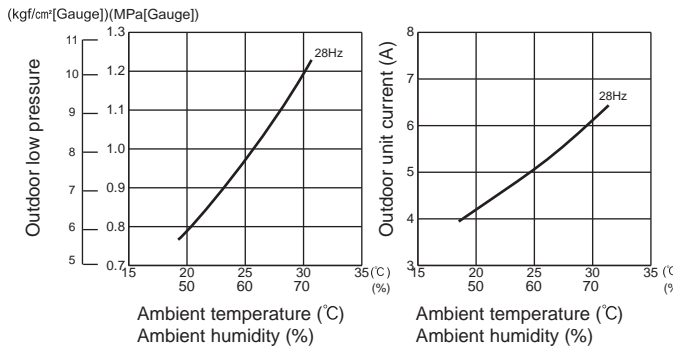

35-class unit

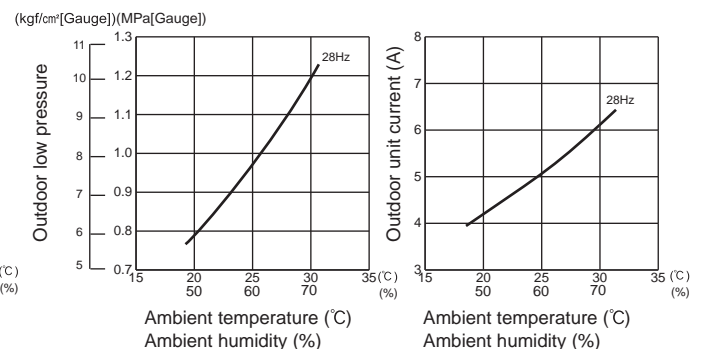

MXZ-4F83VFHZ

42-class unit

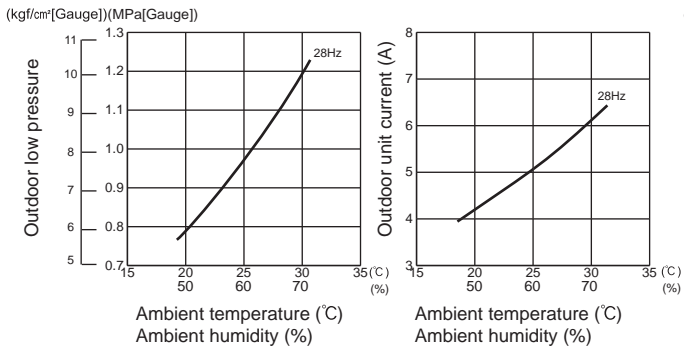

50-class unit

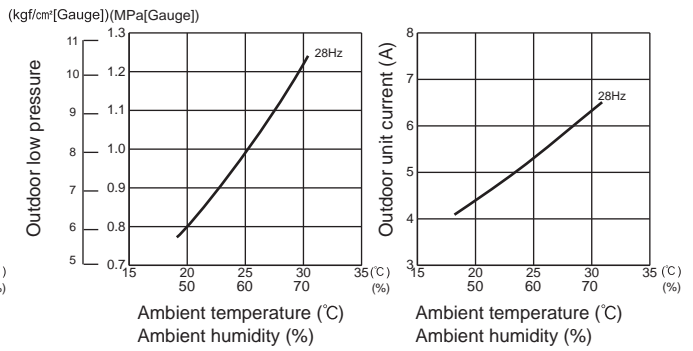

60-class unit

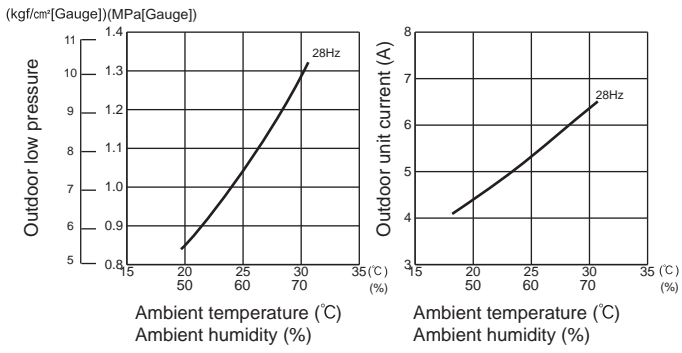

71-class unit

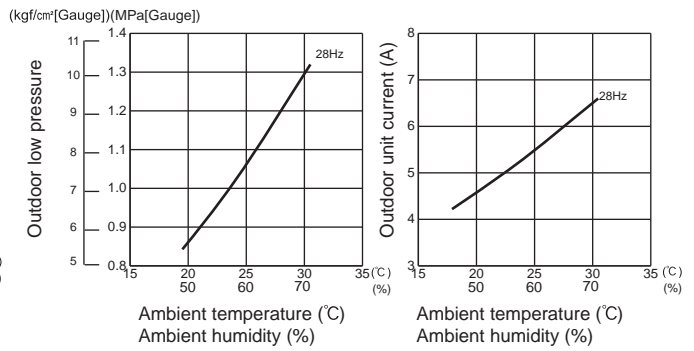

(2) HEAT operation

① Condition :

	Indoor	Outdoor			
Dry bulb temperature (°C)	20.0	2	7	15	20.0
Wet bulb temperature (°C)	14.5	1	6	12	14.5

② Operation : TEST RUN OPERATION (Refer to 9-3.)

MXZ-2F33VF MXZ-2F33VF2 MXZ-2F33VF3

15-class unit

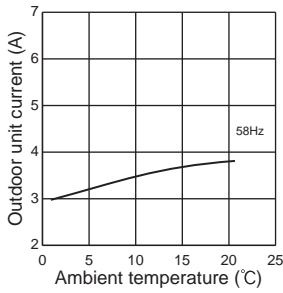

18-class unit

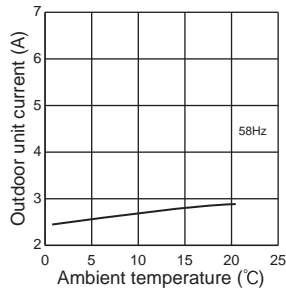

20-class unit

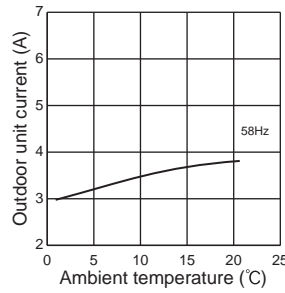

22-class unit

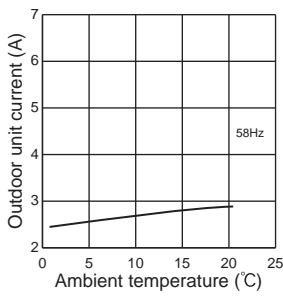

25-class unit

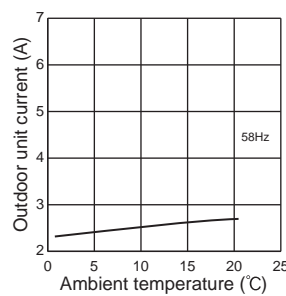

MXZ-2F42VF MXZ-2F42VF2 MXZ-2F42VF3

15-class unit

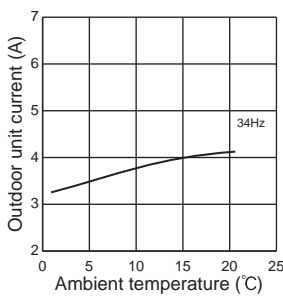

18-class unit

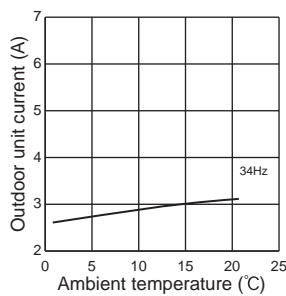

20-class unit

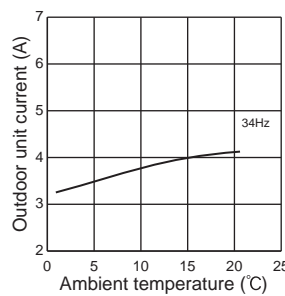

22-class unit

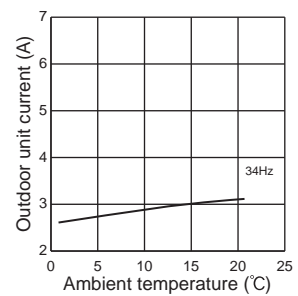

25-class unit

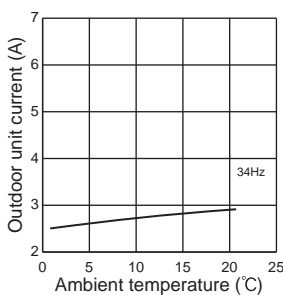

35-class unit

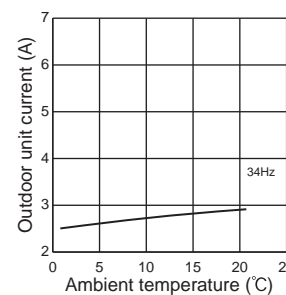

MXZ-2F53VF MXZ-2F53VF2 MXZ-2F53VF3 MXZ-2F53VFH MXZ-2F53VFH2 MXZ-2F53VFH3

15-class unit

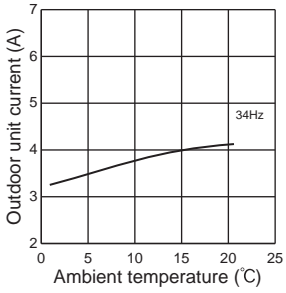

18-class unit

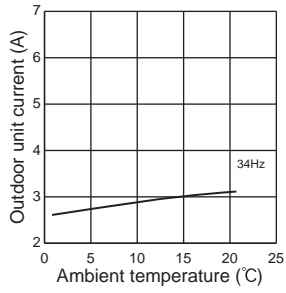

20-class unit

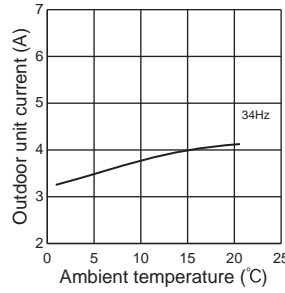

22-class unit

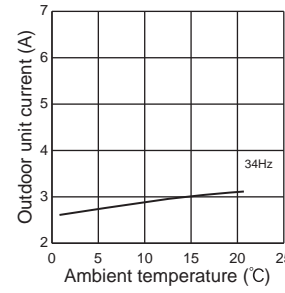

25-class unit

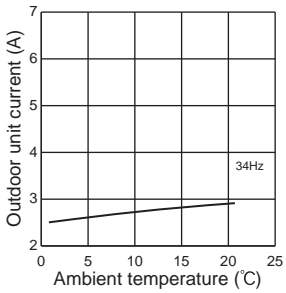

35-class unit

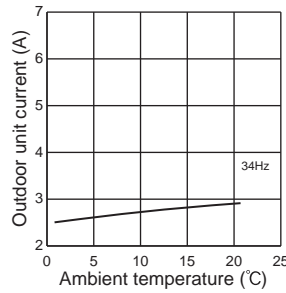

42-class unit

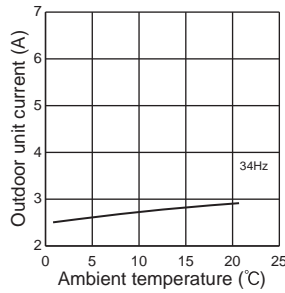

50-class unit

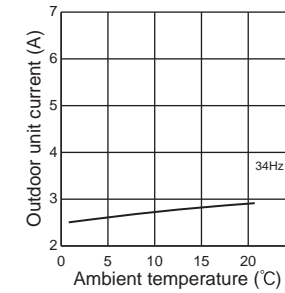

MXZ-3F54VF MXZ-3F54VF2 MXZ-3F54VF3

15-class unit

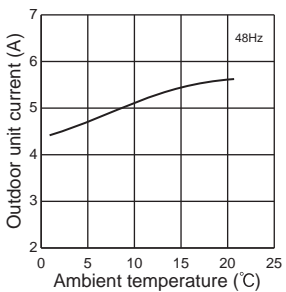

18-class unit

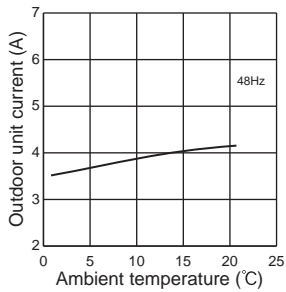

20-class unit

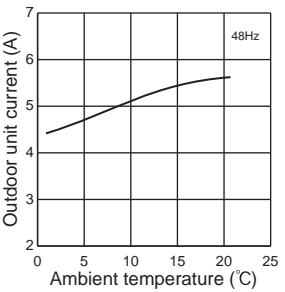

22-class unit

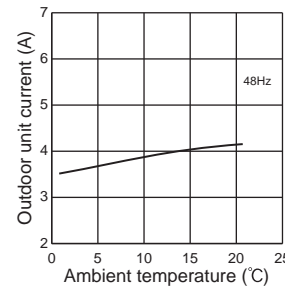

25-class unit

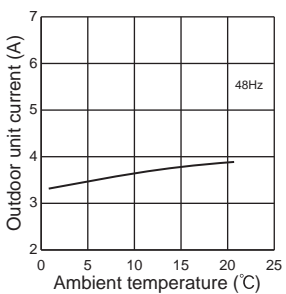

35-class unit

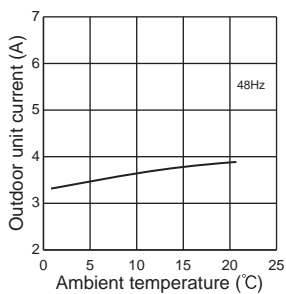

42-class unit

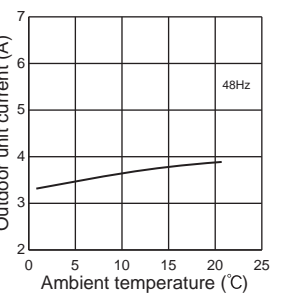

50-class unit

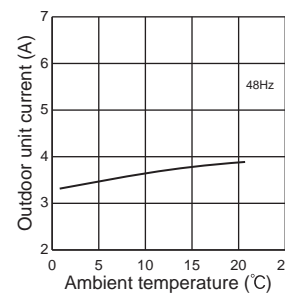

MXZ-3F68VF MXZ-3F68VF2 MXZ-3F68VF3 MXZ-4F72VF MXZ-4F72VF2 MXZ-4F72VF3

15-class unit

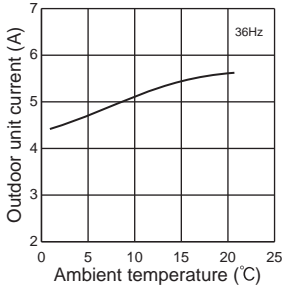

18-class unit

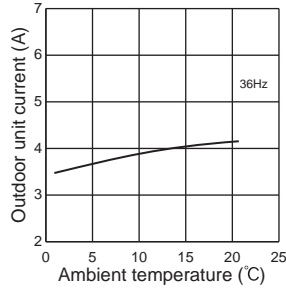

20-class unit

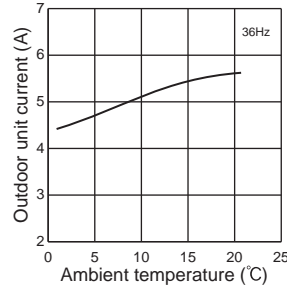

22-class unit

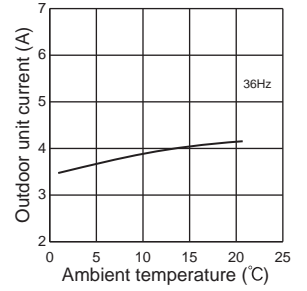

25-class unit

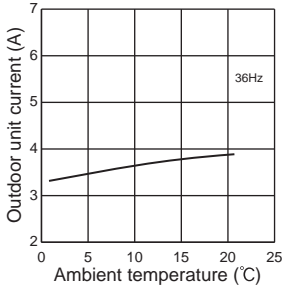

35-class unit

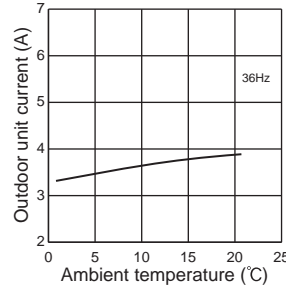

42-class unit

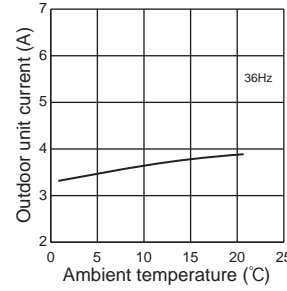

50-class unit

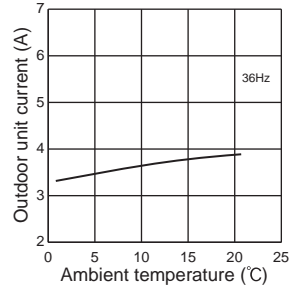

60-class unit

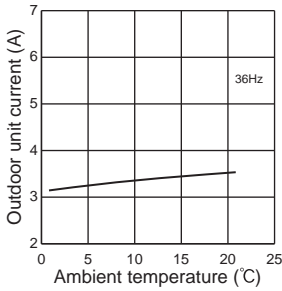

MXZ-4F80VF2 MXZ-4F80VF3

15-class unit

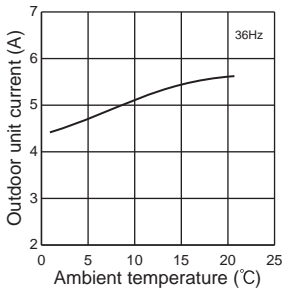

18-class unit

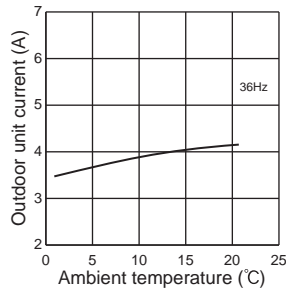

20-class unit

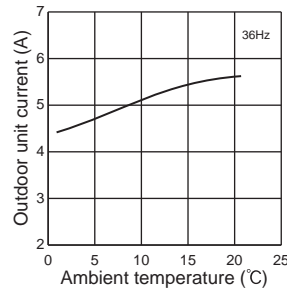

22-class unit

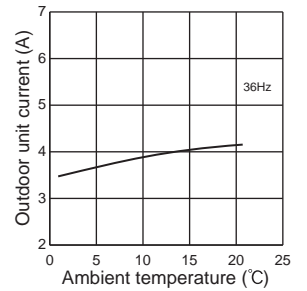

25-class unit

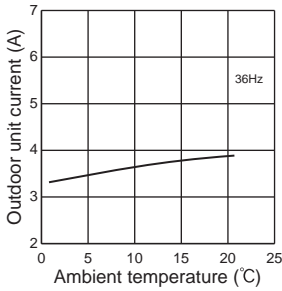

35-class unit

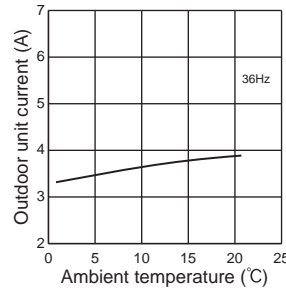

42-class unit

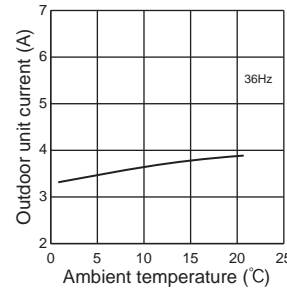

50-class unit

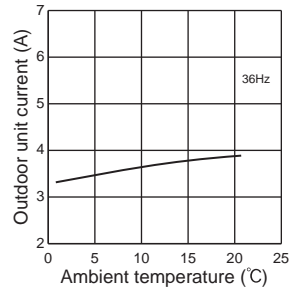

MXZ-4F80VF2 MXZ-4F80VF3

60-class unit

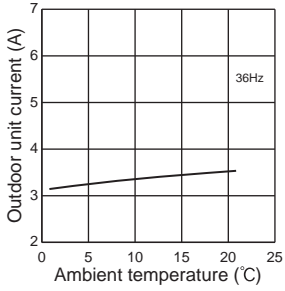

MXZ-4F83VF

15-class unit

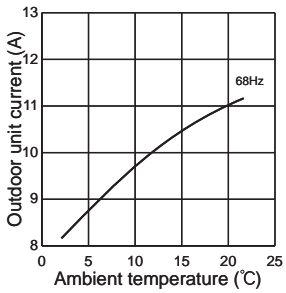

18-class unit

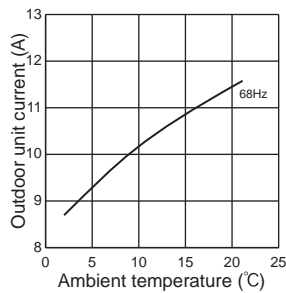

20-class unit

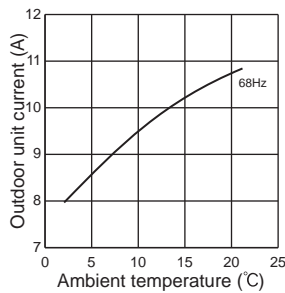

22-class unit

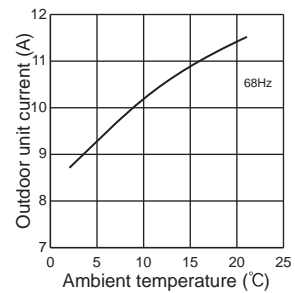

25-class unit

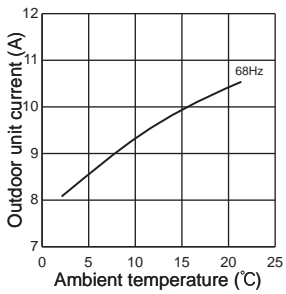

35-class unit

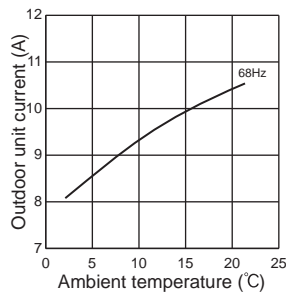

42-class unit

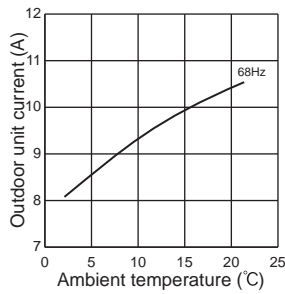

50-class unit

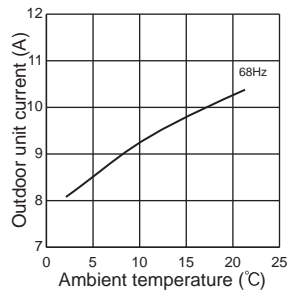

60-class unit

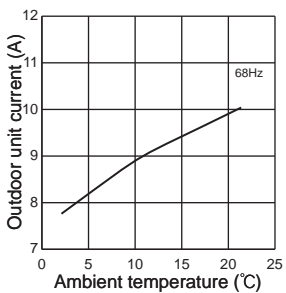

71-class unit

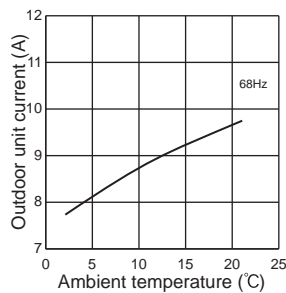

MXZ-5F102VF

15-class unit

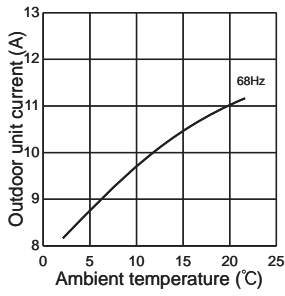

18-class unit

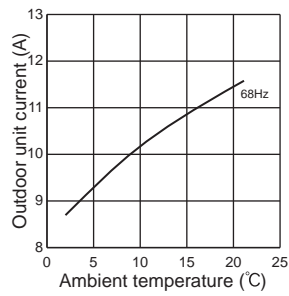

20-class unit

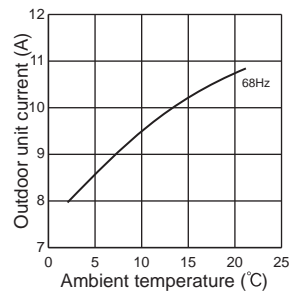

22-class unit

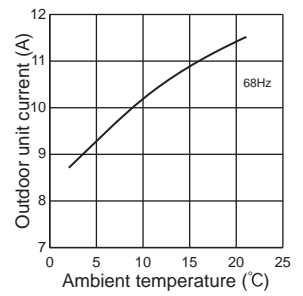

25-class unit

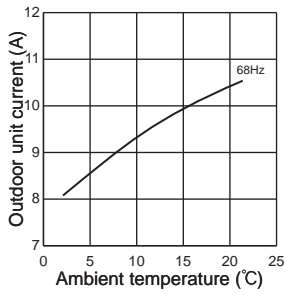

35-class unit

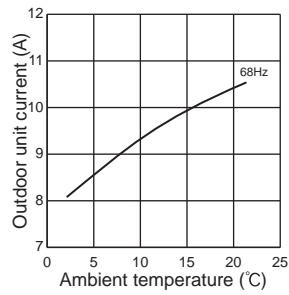

42-class unit

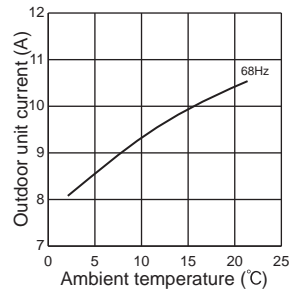

50-class unit

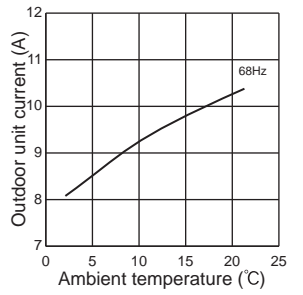

60-class unit

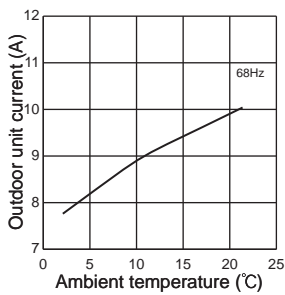

71-class unit

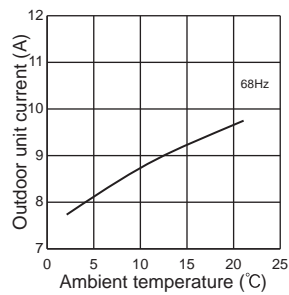

MXZ-6F122VF

15-class unit

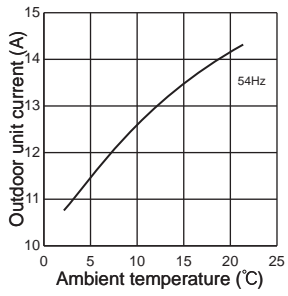

18-class unit

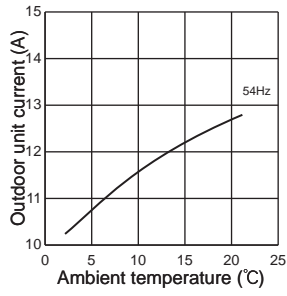

20-class unit

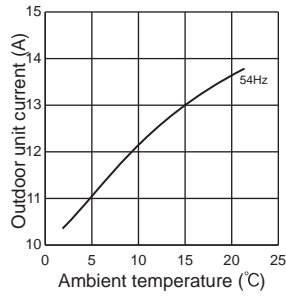

22-class unit

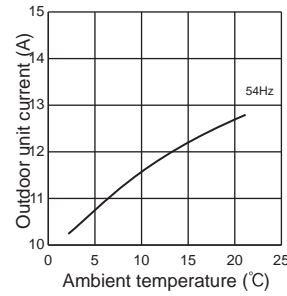

25-class unit

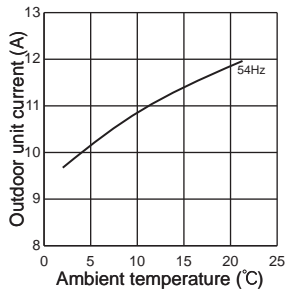

35-class unit

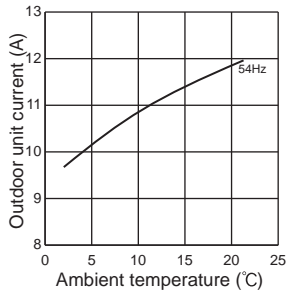

42-class unit

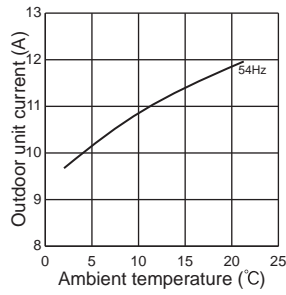

50-class unit

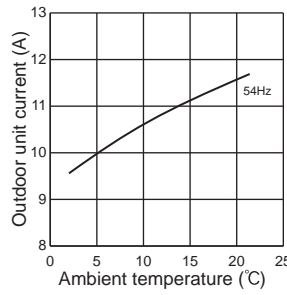

60-class unit

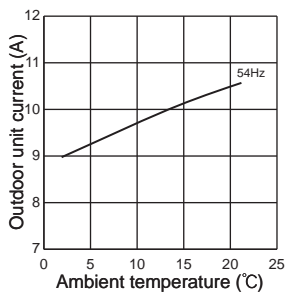

71-class unit

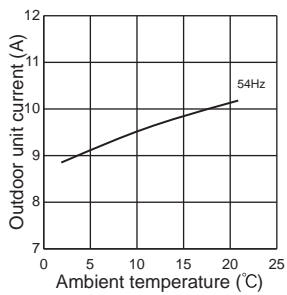

MXZ-2F53VFHZ

15-class unit

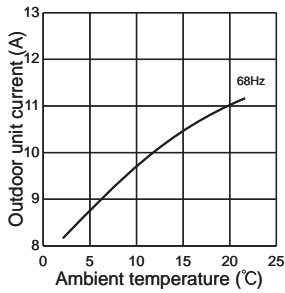

18-class unit

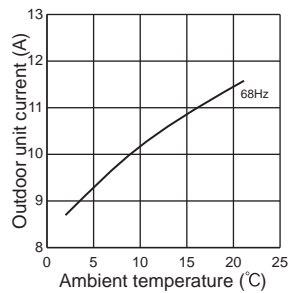

20-class unit

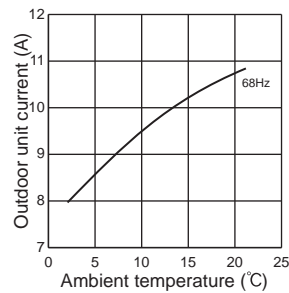

22-class unit

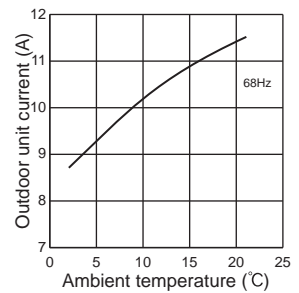

25-class unit

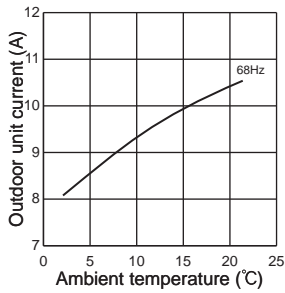

35-class unit

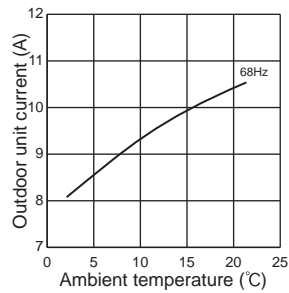

42-class unit

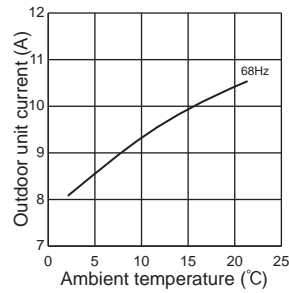

50-class unit

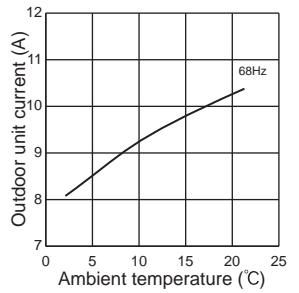

MXZ-4F83VFHZ

15-class unit

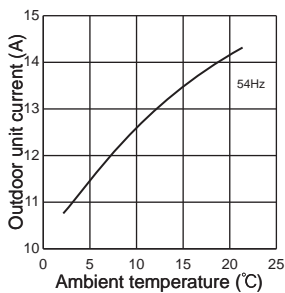

18-class unit

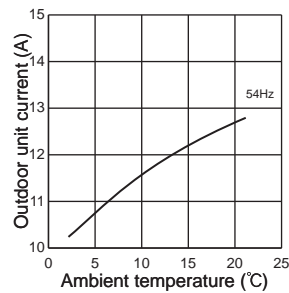

20-class unit

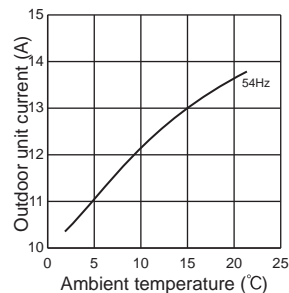

22-class unit

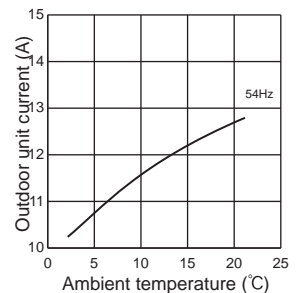

25-class unit

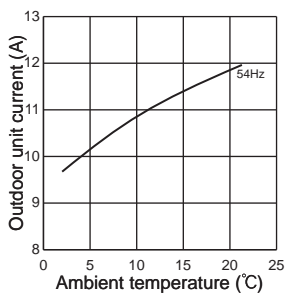

35-class unit

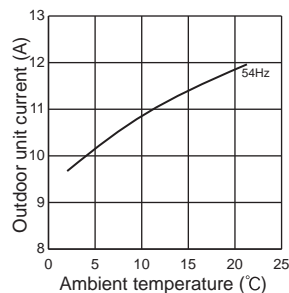

42-class unit

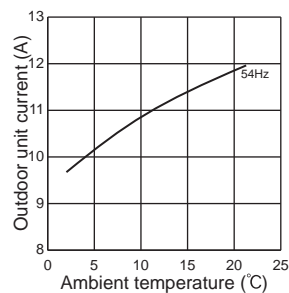

50-class unit

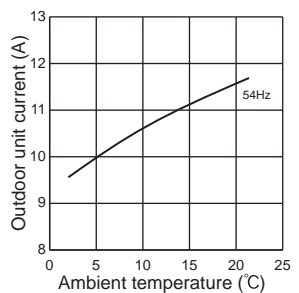

60-class unit

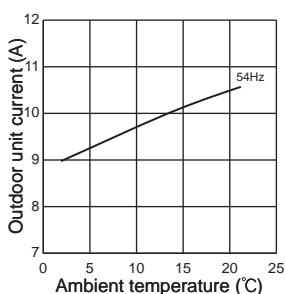

71-class unit

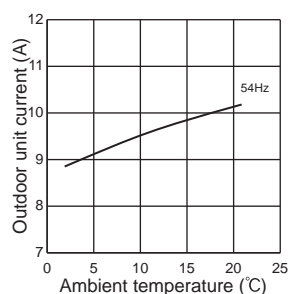

MXZ-2F33VF	MXZ-2F42VF	MXZ-2F53VF	MXZ-2F53VFH
MXZ-2F33VF2	MXZ-2F42VF2	MXZ-2F53VF2	MXZ-2F53VFH2
MXZ-2F33VF3	MXZ-2F42VF3	MXZ-2F53VF3	MXZ-2F53VFH3
MXZ-3F54VF	MXZ-3F68VF	MXZ-4F72VF	
MXZ-3F54VF2	MXZ-3F68VF2	MXZ-4F72VF2	MXZ-4F80VF2
MXZ-3F54VF3	MXZ-3F68VF3	MXZ-4F72VF3	MXZ-4F80VF3

Relation between main sensor and actuator

Sensor	Purpose	Actuator				
		Compressor	LEV	Outdoor fan motor	4-way valve	Defrost heater *1
Discharge temperature thermistor	Protection	○	○			
Indoor coil temperature thermistor	Cooling: Coil frost prevention	○				
	Heating: High pressure protection	○	○			
Defrost thermistor	Heating: Defrosting	○	○	○	○	
Fin temperature thermistor	Protection	○		○		
Ambient temperature thermistor	Control/Protection	○	○	○		
	Heating: Defrosting (Heater)					○
Outdoor heat exchanger temperature thermistor	Cooling: Control/Protection	○	○	○		
Capacity code	Control	○	○			

*1 MXZ-2F53VFH, MXZ-2F53VFH2, MXZ-2F53VFH3

MXZ-4F83VF MXZ-5F102VF MXZ-6F122VF
MXZ-2F53VFHZ MXZ-4F83VFHZ

Relation between main sensor and actuator

Sensor	Purpose	Actuator					
		Compressor	LEV	Outdoor fan motor	4-way valve	2-way solenoid valve *1	Defrost heater *2
Discharge temperature thermistor	Protection	○	○			○	
Indoor coil temperature thermistor	Cooling: Coil frost prevention	○				○	
	Heating: High pressure protection	○	○				
Defrost thermistor	Heating: Defrosting	○	○	○	○		
Fin temperature thermistor	Protection	○		○			
Ambient temperature thermistor	Control/Protection	○	○	○		○	
	Heating: Defrosting (Heater)						○
Outdoor heat exchanger temperature thermistor	Cooling: Control/Protection	○	○	○		○	
Capacity code	Control	○	○				

*1 MXZ-6F122VF, MXZ-4F83VFHZ

*2 MXZ-2F53VFHZ, 4F83VFHZ

MXZ-2F33VF	MXZ-2F42VF	MXZ-2F53VF	MXZ-2F53VFH
MXZ-2F33VF2	MXZ-2F42VF2	MXZ-2F53VF2	MXZ-2F53VFH2
MXZ-2F33VF3	MXZ-2F42VF3	MXZ-2F53VF3	MXZ-2F53VFH3
MXZ-3F54VF	MXZ-3F68VF	MXZ-4F72VF	
MXZ-3F54VF2	MXZ-3F68VF2	MXZ-4F72VF2	MXZ-4F80VF2
MXZ-3F54VF3	MXZ-3F68VF3	MXZ-4F72VF3	MXZ-4F80VF3
MXZ-4F83VF	MXZ-5F102VF	MXZ-6F122VF	
MXZ-2F53VFHZ	MXZ-4F83VFHZ		

11-1. THE POSITION OF SWITCH

<MXZ-2F33VF/2F42VF/2F53VF/2F53VFH, MXZ-2F33VF2/2F42VF2/2F53VF2/2F53VFH2, MXZ-2F33VF3/2F42VF3/2F53VF3/2F53VFH3>

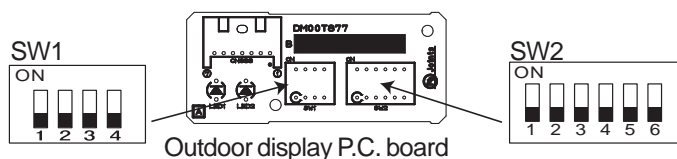

<MXZ-3F54VF/3F68VF/4F72VF, MXZ-3F54VF2/3F68VF2/4F72VF2/4F80VF2, MXZ-3F54VF3/3F68VF3/4F72VF3/4F80VF3>

<MXZ-4F83/5F102/6F122VF/ MXZ-2F53VFHZ/4F83VFHZ>

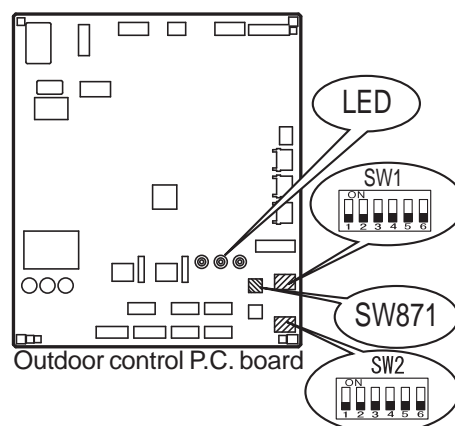
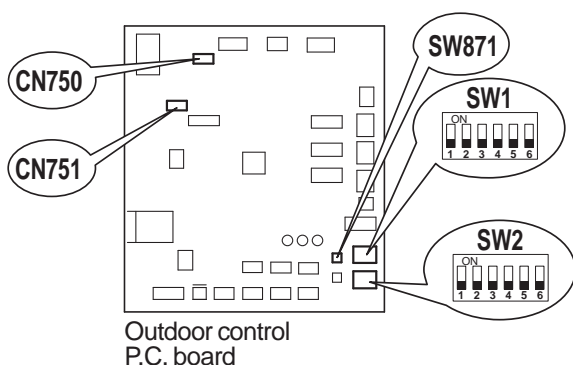

11-2. LOCKING THE OPERATION MODE OF THE AIR CONDITIONER (COOL, DRY, HEAT)

With this function, once the operation mode is locked to either COOL/DRY mode or HEAT mode, the air conditioner operates in that mode only.

Changing the setting is required to activate this function. Explain about this function to your customers and ask them whether they want to use it.

[How to lock the operation mode]

- (1) Turn OFF the power supply and make sure that the LED goes off.
- (2) Set SW1 as shown in the figure below.
- (3) Turn ON the power supply.

<MXZ-2F33VF/2F42VF/2F53VF/2F53VFH
MXZ-2F33VF2/2F42VF2/2F53VF2/2F53VFH2
MXZ-2F33VF3/2F42VF3/2F53VF3/2F53VFH3>

<MXZ-3F54VF/3F68VF/4F72VF
MXZ-3F54VF2/3F68VF2/4F72VF2/4F80VF2
MXZ-3F54VF3/3F68VF3/4F72VF3/4F80VF3
MXZ-4F83/5F102/6F122VF/2F53VFHZ/4F83VFHZ>

SW1 on the outdoor display P.C. board

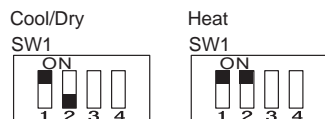

SW1 on the outdoor control P.C. board

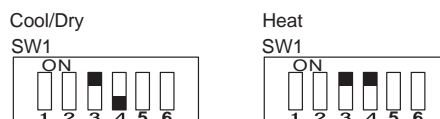

11-3. HOW TO SET LOW STANDBY POWER MODE

**MXZ-3F54VF MXZ-3F68VF MXZ-4F72VF
MXZ-3F54VF2 MXZ-3F68VF2 MXZ-4F72VF2 MXZ-4F80VF2**

- The factory setting of low standby power mode for above units is “Activated”.

In case that compressor is not in operation, and both LED1 (Red) and LED2 (Yellow) are not lit, check the setting of low standby power mode on the outdoor control P.C. board. And check the settings for dip switch (SW1) and jumper connector (SC751).

- Before turning on the breaker, settings for dip switch (SW1) and jumper connector (SC751) are necessary on the outdoor control P.C. board.

- When connecting one or more indoor units listed in Table 1, change the setting to deactivated low standby power mode.

NOTE:

- Units come with low standby power mode activated as factory setting.
- When connecting one or more indoor units listed in Table 1, the outdoor unit does not work at activated low standby power mode.
- In the event that SC751 is missing, outdoor unit will not work.

Table 1: List of the target models

Type	Model name	Capacity
Wall-mounted	MSZ-AP**VF	15 / 20
1way-cassette	MLZ-KP**VF	25 / 35 / 50
4way-cassette	SLZ-M**FA	15 / 25 / 35 / 50
Ceiling-Concealed	PEAD-M**JA(L)	50
	SEZ-M**DA(L)	25 / 35 / 50 / 60
Ceiling-Suspended	PCA-M**KA	50 / 60

To activate low standby power mode:

Connect SC751 to CN750.
Set “2” on SW1 to ON.

To deactivate low standby power mode:

Connect SC751 to CN751.
Set “2” on SW1 to OFF.

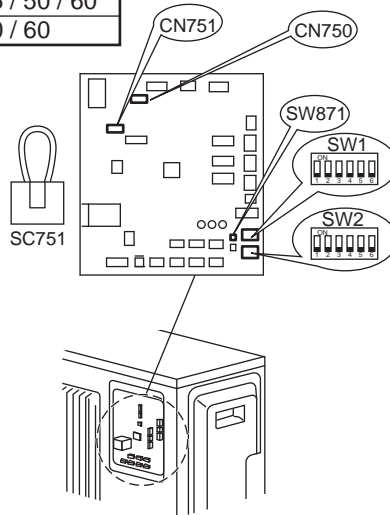

SC751	SW1	MODE
CN750		Activated
CN751		Deactivated

**MXZ-3F54VF3 MXZ-3F68VF3 MXZ-4F72VF3 MXZ-4F80VF3
MXZ-4F83VF MXZ-5F102VF MXZ-6F122VF**

•The factory setting of low standby power mode for above units is “Deactivated”.

In case that compressor is not in operation, and both LED1 (Red) and LED2 (Yellow) are not lit, check the setting of low standby power mode on the outdoor control P.C. board. And check the settings for dip switch (SW1) and jumper connector (SC751).

•Before turning on the breaker, settings for dip switch (SW1) and jumper connector (SC751) are necessary on the outdoor control P.C. board.
•It is recommended to activate the low standby power mode when none of the indoor units listed in Table 1 is connected.
NOTE:

- Units come with low standby power mode deactivated as factory setting.
- When connecting one or more indoor units listed in Table 1, the outdoor unit does not work at activated low standby power mode.
- In the event that SC751 is missing, outdoor unit will not work.

Table 1: List of the target models

Type	Model name
Wall-mounted	MSZ-AP**VF
1way-cassette	MLZ-KP**VF
4way-cassette	SLZ-M**FA
Ceiling-Concealed	PEAD-M**JA(L)
	SEZ-M**DA(L)
Ceiling-Suspended	PCA-M**KA
Floor-Standing	SFZ-M**VA

To activate low standby power mode:

Connect SC751 to CN750.
Set “2” on SW1 to ON.

To deactivate low standby power mode:

Connect SC751 to CN751.
Set “2” on SW1 to OFF.

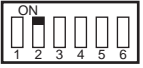
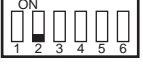
SC751	SW1	MODE
CN750		Activated
CN751		Deactivated

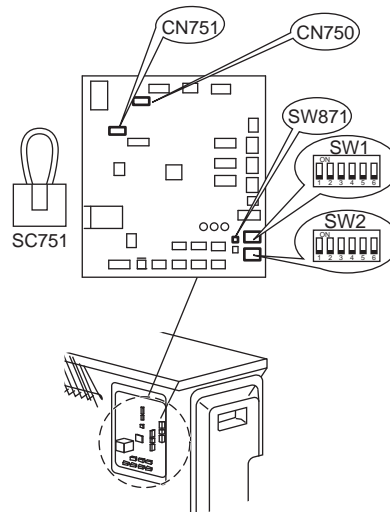

11-4. LOWERING THE OPERATING NOISE OF THE OUTDOOR UNIT

With this function, the operating noise of the outdoor unit can be lowered by reducing the operation load, for example, during nighttime in COOL mode.

However, note that the cooling and heating capacity may lower if this function is activated.

Changing the setting is required to activate this function. Explain about this function to your customers and ask them whether they want to use it.

**<MXZ-2F33VF/2F42VF/2F53VF/2F53VFH
MXZ-2F33VF2/2F42VF2/2F53VF2/2F53VFH2
MXZ-2F33VF3/2F42VF3/2F53VF3/2F53VFH3>**

[How to lower the operating noise]

- (1) Turn OFF the power supply and make sure that the LED goes off.
- (2) Set "3" on SW1 to ON to enable this function.
- (3) Turn ON the power supply.

SW1 on the outdoor display P.C. board

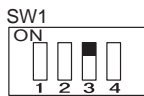

**<MXZ-3F54VF/3F68VF/4F72VF
MXZ-3F54VF2/ 3F68VF2/4F72VF2/4F80VF2
MXZ-3F54VF3/3F68VF3/4F72VF3/4F80VF3
MXZ-4F83/5F102/6F122VF/MXZ-2F53/4F83VFHZ>**

[How to lower the operating noise]

- (1) Turn OFF the power supply and make sure that the LED goes off.
- (2) Set "5" on SW1 to ON to enable this function.
- (3) Turn ON the power supply.

SW1 on the outdoor control P.C. board



11-5. AUTOMATIC LINE CORRECTING

<MXZ-2F33VF/2F42VF/2F53VF/2F53VFH, MXZ-2F33VF2/2F42VF2/2F53VF2/2F53VFH2, MXZ-2F33VF3/2F42VF3/2F53VF3/2F53VFH3>

This outdoor unit has an automatic line correcting function which automatically detects and corrects improper wiring or piping.

<MXZ-2F33VF/2F42VF/2F53VF/2F53VFH, MXZ-2F33VF2/2F42VF2/2F53VF2/2F53VFH2, MXZ-2F33VF3/2F42VF3/2F53VF3/2F53VFH3>

Improper wiring or piping can be automatically detected when one indoor unit is operated in COOL mode for 30 minutes. When improper wiring or piping is detected, wiring lines are corrected (A to B/ B to A) with the software.

NOTE: This function may not work due to the condition or environment of the unit, such as the following:

- gas leak, closed stop valve
- unit failure such as defective LEV
- indoor/outdoor temperature

NOTE: This function does not work when "2" on SW2 on the outdoor display P.C. board is turned OFF.

<Correct>

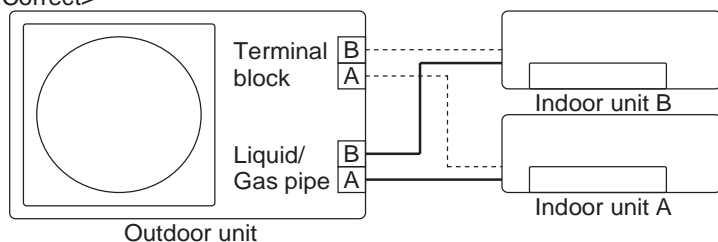

**MXZ-2F33VF/2F42VF/2F53VF/2F53VFH
MXZ-2F33VF2/2F42VF2/2F53VF2/2F53VFH2
MXZ-2F33VF3/2F42VF3/2F53VF3/2F53VFH3
SW2 on the outdoor display P.C. board**

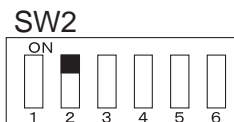

<Incorrect wiring>

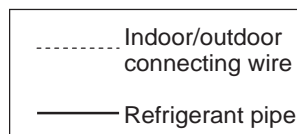
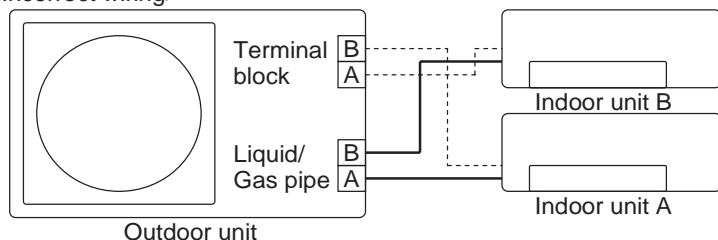

<Incorrect piping>

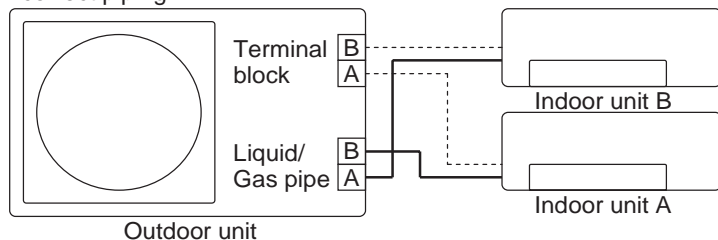

The record of automatic line correcting can be checked in the following way:

- (1) Turn OFF the power supply and make sure that the LED goes off.
- (2) Turn ON "3" on SW2 on the outdoor display P.C. board.
- (3) Turn ON the power supply.
- (4) Check the correction state with the LED lamps on the outdoor display P.C. board.
- (5) Turn OFF the power supply and make sure that the LED goes off.
- (6) Turn OFF "3" on SW2 on the outdoor display P.C. board.
- (7) Turn ON the power supply.

Number of blinks		Wiring line
LED1 (Red)	LED2 (Yellow)	
Once	Once	Not corrected
3 times	3 times	Corrected

**MXZ-2F33VF/2F42VF/2F53VF/2F53VFH
MXZ-2F33VF2/2F42VF2/2F53VF2/2F53VFH2
MXZ-2F33VF3/2F42VF3/2F53VF3/2F53VFH3
SW2 on the outdoor display P.C. board**

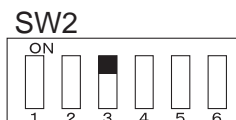

<MXZ-3F54VF/3F68VF/4F72VF, MXZ-3F54VF2/3F68VF2/4F72VF2/4F80VF2, MXZ-3F54VF3/3F68VF3/4F72VF3/4F80VF3, MXZ-4F83/5F102/6F122VF, MXZ-2F53/4F83VFHZ>

Outdoor unit has an auto line correcting function which automatically detects and corrects improper wiring or piping.

Improper wiring or piping can be automatically detected by pressing the piping/wiring correction switch (SW871).
When improper wiring or piping is detected, wiring lines are corrected.
This will be completed in about 10 to 15 minutes.

[How to activate this function]

1. Check that outside temperature is above 0°C.
(This function does not work when the outside temperature is 0°C or below.)
2. Check that the stop valves of the liquid pipe and gas pipe are open.
3. Check that the wiring between indoor and outdoor unit is correct.
(If the wiring is not correct, this function does not work.)
4. Turn ON the power supply and wait at least 1 minute.
5. Press the piping/wiring correction switch (SW871) on the outdoor control P.C. board.
Do not touch energized parts.

LED indication during detection:

LED1 (Red)	LED2 (Yellow)	LED3 (Green)
Lit	Lit	Once

LED indication after detection:

LED1 (Red)	LED2 (Yellow)	LED3 (Green)	Result
Lit	Not lit	Lit	Completed (Problem corrected/ normal)
Once	Once	Once	Not completed (Detection failed)
Other indications			Refer to "SAFETY PRECAUTIONS WHEN LED BLINKS" located behind the top panel.

* Make sure that the valves are open and the pipes are not collapsed or clogged.

6. Press the switch to cancel.

LED indication after cancel :

LED1 (Red)	LED2 (Yellow)	LED3 (Green)
Lit	Lit	Not lit

NOTE: Indoor unit cannot be operated while this function is activated.
When this function is activated while indoor unit is operating, the operation will be stopped.
Operate indoor unit after the auto line correcting is finished.
Pressing the switch during detection cancels this function.

The record of auto line correcting can be confirmed in the following way:

Press the switch for more than 5 seconds.

LED will show the record of auto correcting for about 30 seconds as shown in the table below:

Number of blinks			Wiring line
LED1 (Red)	LED2 (Yellow)	LED3 (Green)	
Once	Once	Lit	Not corrected
3 times	3 times	Lit	Corrected

NOTE: Activate this function to confirm the correct wiring after replacing the outdoor control P.C. board.
(Previous records are deleted when the outdoor control P.C. board is replaced.)
The record cannot be shown if auto line correcting is not canceled (Refer to "How to activate this function").

11-6. CHANGING THE SET REFRIGERANT EVAPORATING TEMPERATURE

NOTE: If you lower the refrigerant evaporating temperature with the windows open, it may cause dew drop.

[How to change the refrigerant evaporating temperature]

- (1) Make sure there is no possibility of causing dew drop before making the setting.
- (2) Make the setting referring to the table below.

SW2 on the outdoor control P.C. board

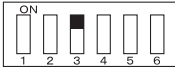
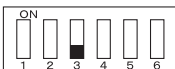
SW2	MXZ-3F54VF MXZ-3F68VF MXZ-4F72VF	MXZ-3F54VF2/VF3 MXZ-3F68VF2/VF3 MXZ-4F72VF2/VF3 MXZ-4F80VF2/VF3	MXZ-4F83VF MXZ-5F102vf MXZ-6F122VF MXZ-2F53VFHZ MXZ-4F83VFHZ
	7 °C or 9 °C	6 °C	
	Normal control		

11-7. CHANGING THE AMPERE LIMIT

<MXZ-2F53VFHZ/4F83VFHZ/MXZ-6F122VF>

With this function, the amount of current that flows in the outdoor unit can be changed.

NOTE: Use this function only when the amount of current exceeds the allowed value.

[How to change the ampere limit]

- (1) Be sure to turn off the power supply for the air conditioner before making the setting.
- (2) Make the setting referring to the table below.
- (3) Turn ON the power supply.

SW2 on the outdoor control P.C. board

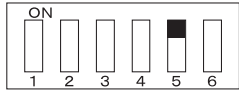
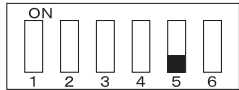
SW2	MXZ-2F53VFHZ	MXZ-4F83VFHZ	MXZ-6F122VF
	13.6 A (Factory setting)	21 A	20 A
	18.4 A	Full (Factory setting)	Full (Factory setting)

MXZ-2F33VF	MXZ-2F42VF	MXZ-2F53VF	MXZ-2F53VFH
MXZ-2F33VF2	MXZ-2F42VF2	MXZ-2F53VF2	MXZ-2F53VFH2
MXZ-2F33VF3	MXZ-2F42VF3	MXZ-2F53VF3	MXZ-2F53VFH3
MXZ-3F54VF	MXZ-3F68VF	MXZ-4F72VF	
MXZ-3F54VF2	MXZ-3F68VF2	MXZ-4F72VF2	MXZ-4F80VF2
MXZ-3F54VF3	MXZ-3F68VF3	MXZ-4F72VF3	MXZ-4F80VF3
MXZ-4F83VF	MXZ-5F102VF	MXZ-6F122VF	
MXZ-2F53VFHZ	MXZ-4F83VFHZ		

12-1. CAUTIONS ON TROUBLESHOOTING

1. Before troubleshooting, check the following:

- 1) Check the power supply voltage.
- 2) Check the indoor/outdoor connecting wire for miswiring.

2. Take care of the following during servicing

- 1) Before servicing the air conditioner, be sure to turn OFF the unit first with the remote controller, and after confirming the horizontal vane is closed, turn OFF the breaker and/or disconnect the power plug.
- 2) Be sure to turn OFF the power supply before removing the front panel, the cabinet, the top panel, and the P.C. board.
- 3) When removing the electrical parts, be careful of the residual voltage of smoothing capacitor.
- 4) When removing the P.C. board, hold the edge of the board with care NOT to apply stress on the components.
- 5) When connecting or disconnecting the connectors, hold the connector housing. DO NOT pull the lead wires.

<Incorrect>



Lead wiring

<Correct>



Connector housing

3. Troubleshooting procedure

- 1) Check if the OPERATION INDICATOR lamp on the indoor unit is blinking on and off to indicate an abnormality. To make sure, check how many times the OPERATION INDICATOR lamp is blinking on and off before starting service work.
- 2) Before servicing, check that the connector and terminal are connected properly.
- 3) When the P.C. board seems to be defective, check the copper foil pattern for disconnection and the components for bursting and discoloration.
- 4) Refer to 12-2, 12-3 and 12-4.

12-2. FAILURE MODE RECALL FUNCTION

This air conditioner can memorize the abnormal condition which has occurred once.

Even though LED indication listed on the troubleshooting check table (12-4.) disappears, the memorized failure details can be recalled.

1. Flow chart of failure mode recall function for the indoor/outdoor unit

Refer to the service manual of indoor unit.

2. Flow chart of the detailed outdoor unit failure mode recall function

Operational procedure

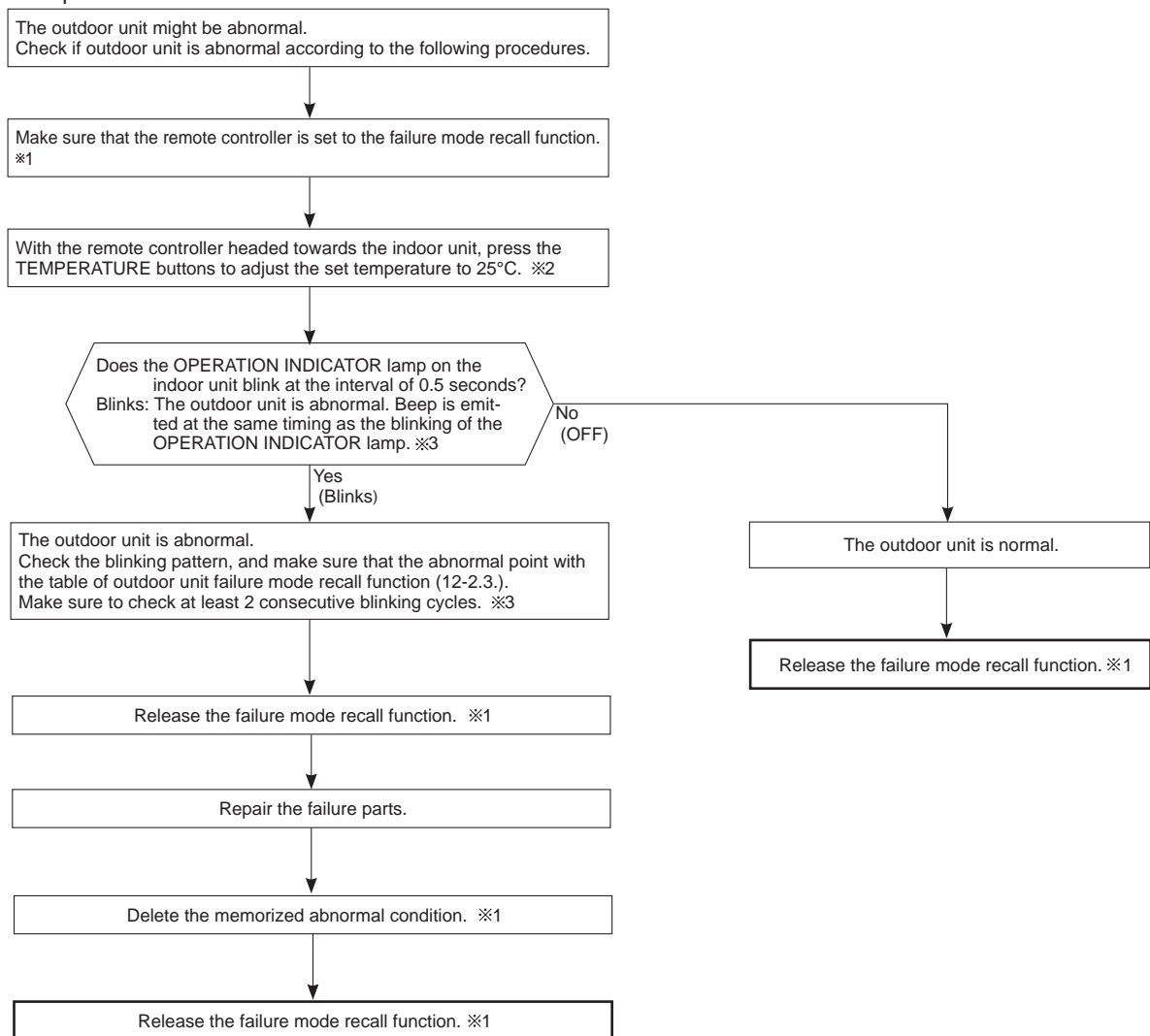

NOTE: 1. Make sure to release the failure mode recall function after it is set up, otherwise the unit cannot operate properly.
2. If the abnormal condition is not deleted from the memory, the last abnormal condition is kept memorized.

※1. Refer to the service manual of indoor unit.

※2. Regardless of normal or abnormal condition, 2 short beeps are emitted as the signal is received.

※3. Blinking pattern when outdoor unit is abnormal:

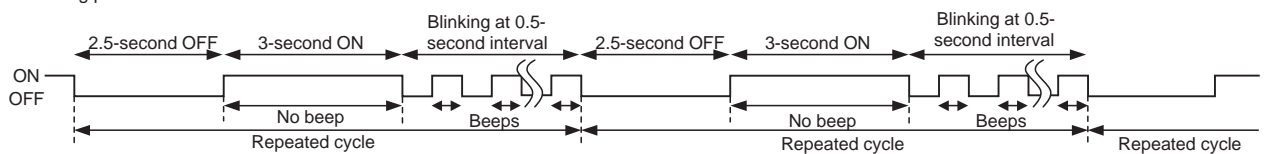

3. Table of outdoor unit failure mode recall function
MXZ-2F33/42/53VF/VF2/VF3, MXZ-2F53VFH/VFH2/VFH3

NOTE: Blinking patterns of this mode differ from the ones of Troubleshooting check table (12-4).

Upper or left lamp of OPERATION INDICATOR lamp (Indoor unit)	Abnormal point (Failure mode/protection)	LED indication (Outdoor P.C. board)		Condition	Remedy	Indoor/outdoor unit failure mode recall function
		LED 1	LED 2			
OFF	None (Normal)	Not lit	Not lit	—	—	—
2-time blink	Outdoor power system	Lit	Lit	Overcurrent protection cut-out operates 3 consecutive times within 1 minute after the compressor gets started. Compressor protection cut-out operates 24 consecutive times within 10 seconds after the compressor gets started.	<ul style="list-style-type: none"> Check the compressor connecting wire. Refer to 12-6. ㉔ "How to check inverter/compressor". Check the stop valve. 	○
3-time blink	Discharge temperature thermistor	Lit	Once	Thermistor shorts or opens during compressor running.	<ul style="list-style-type: none"> Refer to 12-6. ㉔ "Check of outdoor thermistors". 	○
	Defrost thermistor	Lit	Once			○
	Ambient temperature thermistor	Lit	Twice			○
	Fin temperature thermistor	Lit	3 times			○
	P.C. board temperature thermistor	Lit	4 times			○
	Outdoor heat exchanger temperature thermistor	Lit	9 times			○
4-time blink	Overcurrent	Once	Not lit	The overcurrent flows into intelligent power module.	<ul style="list-style-type: none"> Check the compressor connecting wire. Refer to 12-6. ㉔ "How to check inverter/compressor". Check the stop valve. 	—
	Compressor	Twice	Not lit	The overcurrent flows into intelligent power module within 10 seconds after the compressor gets started. (The compressor gets restarted in 15 seconds.)	<ul style="list-style-type: none"> Check the compressor connecting wire. Refer to 12-6. ㉔ "How to check inverter/compressor". 	—
		9 times	Not lit	Waveform of compressor current is distorted.		—
5-time blink	Discharge temperature	Lit	Lit	Discharge temperature exceeds 116°C during operation.	<ul style="list-style-type: none"> Check the refrigerant circuit and the refrigerant amount. Refer to 12-6. ㉔ "Check of LEV". 	—
6-time blink	High pressure	Lit	Lit	The outdoor heat exchanger temperature exceeds 70°C during cooling or the indoor gas pipe temperature exceeds 70°C during heating.	<ul style="list-style-type: none"> Check the refrigerant circuit and the refrigerant amount. Check the stop valve. 	—
7-time blink	Fin temperature	3 times	Not lit	The fin temperature exceeds 90°C during operation.	<ul style="list-style-type: none"> Check the around outdoor unit. Check the outdoor unit air passage. 	—
	P.C. board temperature	4 times	Not lit	The P.C. board temperature exceeds 80°C during operation.	<ul style="list-style-type: none"> Refer to 12-6. ㉔ "Check of outdoor fan motor". 	—
8-time blink	Outdoor fan motor	Lit	Lit	Failure occurs 3 consecutive times within 30 seconds after the fan gets started.	<ul style="list-style-type: none"> Refer to 12-6. ㉔ "Check of outdoor fan motor". 	—
9-time blink	Nonvolatile memory data	Lit	5 times	Nonvolatile memory data cannot be read properly.	<ul style="list-style-type: none"> Replace the inverter P.C. board. 	○
	Power module	7 times	Not lit	The output of the power module that drove the compressor was shorted or the winding of the compressor was shorted.	<ul style="list-style-type: none"> Refer to 12-6. ㉔ "How to check inverter/compressor". 	○
10-time blink	Discharge temperature	Lit	Lit	The discharge temperature is kept under 50°C (COOL mode)/40°C (HEAT mode) for more than 40 minutes.	<ul style="list-style-type: none"> Check the refrigerant circuit and the refrigerant amount. Refer to 12-6. ㉔ "Check of LEV". 	—
11-time blink	Current sensor	8 times	Not lit	The sensor circuit of current of compressor shorts or opens during compressor operate.	<ul style="list-style-type: none"> Replace the inverter P.C. board. 	○
	Bus-bar voltage	6 times	Not lit	The bus-bar voltage exceeds 430 V or falls to 50 V or below during compressor operating.	<ul style="list-style-type: none"> Check the power supply. Replace the inverter P.C. board. 	○
14-time blink	Stop valve	Lit	12 times	The current of compressor is power module is out of order.	<ul style="list-style-type: none"> Check the stop valve. Check the refrigerant circuit and the refrigerant amount. 	○
	Refrigerant leakage (Sensor detection)	Lit	Lit	1. Refrigerant leaks from the piping or the heat exchanger in the indoor unit. 2. The following items are used around the indoor unit. <ul style="list-style-type: none"> Spray (LP gas including Freon, and whose main ingredient is propane and butane) Aerosol insecticide (including ethanol) Air spray painting (including dichloromethane) Charcoal (charcoal fire) Chemicals (such as ethanol) 	<ul style="list-style-type: none"> Turn off the power after the indoor unit finishes its FAN operation. (The FAN operation continues for 3 hours.) Check the indoor unit to detect the part where refrigerant leaks. Repair the part where refrigerant leaks. Turn on the power again. Replace the refrigerant sensor if the problem is not fixed. 	○



Upper or left lamp of OPERATION INDICATOR lamp (Indoor unit)	Abnormal point (Failure mode/protection)	LED indication (Outdoor P.C. board)		Condition	Remedy	Indoor/outdoor unit failure mode recall function
		LED 1	LED 2			
14-time blink	Refrigerant leakage (Sensor detection)	Lit	Lit	The refrigerant sensor mounted on the indoor unit does not work. The refrigerant sensor is not connected properly or the wire is broken.	<ul style="list-style-type: none"> • Connect the connector of the refrigerant sensor properly. • Replace the refrigerant sensor. 	○
	Incompatible unit combination	Lit	11 times	The indoor unit which is not compatible with the outdoor unit is connected.	<ul style="list-style-type: none"> • Replace the indoor unit with the one which is compatible with the outdoor unit. 	○
17-time blink	Outdoor refrigerant system abnormality	Lit	17 times	A closed valve and air trapped in the refrigerant circuit are detected based on the temperature sensed by the indoor and outdoor thermistors and the current of the compressor.	<ul style="list-style-type: none"> • Check for a gas leak in a connecting piping etc. • Check the stop valve. • Refer to 12-6. ㊦ "Check of outdoor refrigerant circuit". 	○

NOTE: Blinking patterns of this mode differ from the ones of Troubleshooting check table (12-4.).

MXZ-3F, 4F, 5F, 6F, MXZ-2F53VFHZ, MXZ-4F83VFHZ

The left lamp of OPERATION INDICATOR lamp (Indoor unit)	Abnormal point (Failure mode/protection)	LED indication (Outdoor P.C. board)		Condition	Remedy	Indoor/outdoor unit failure mode recall function
		LED1	LED2			
OFF	None (Normal)	Lit	Lit			
2-time blink	Outdoor power system	Lit	Lit	Overcurrent protection cut-out operates 3 consecutive times within 1 minute after the compressor gets started, or converter protection cut-out or bus-bar voltage protection cut-out operates 3 consecutive times within 3 minutes after startup.	<ul style="list-style-type: none"> Check the connection of the compressor connecting wire. Refer to 12-6. ㊦ "How to check inverter/compressor". Check the stop valve. 	○
3-time blink	Discharge temperature thermistor	Lit	Once	A thermistor shorts or opens during compressor running.	<ul style="list-style-type: none"> Refer to 12-6. ㊦ "Check of outdoor thermistors". 	○
	Defrost thermistor	Lit	Once			
	Ambient temperature thermistor	Lit	Twice			
	Fin temperature thermistor	Lit	3 times			
	P.C. board temperature thermistor	Lit	4 times			
Outdoor heat exchanger temperature thermistor	Lit	9 times				
4-time blink	Overcurrent	Once	Not lit	21 A current flows into power module.	<ul style="list-style-type: none"> Reconnect compressor connector. Refer to 12-6. ㊦ "How to check inverter/compressor". Check the stop valve. 	—
5-time blink	Discharge temperature	Lit	Lit	The discharge temperature exceeds 115°C (MXZ-3F54/3F68/4F72VF/VF2/VF3/4F80VF2/VF3)/ 106°C (MXZ-4F83/5F102VF, MXZ-2F53VFHZ)/ 116°C (MXZ-4F83VFHZ) during operation. Compressor can restart if discharge temperature thermistor reads 80°C (MXZ-3F54/3F68/4F72VF/VF2/VF3)/95°C (MXZ-4F83/5F102VF, MXZ-2F53VFHZ)/100°C (MXZ-6F122VF, MXZ-4F83VFHZ) or less 3 minutes later.	<ul style="list-style-type: none"> Check refrigerant circuit and refrigerant amount. Refer to 12-6. ㊦ "Check of LEV". 	—
6-time blink	High pressure	Lit	Lit	The outdoor heat exchanger temperature exceeds 70°C during cooling or the indoor gas pipe temperature exceeds 70°C during heating.	<ul style="list-style-type: none"> Check refrigerant circuit and refrigerant amount. Check the stop valve. 	—
7-time blink	Fin temperature	3 times	Not lit	The fin temperature exceeds 88°C (MXZ-3F54/3F68/4F72VF/VF2/VF3/4F83/5F102VF, MXZ-2F53VFHZ)/89°C (MXZ-6F122VF, MXZ-4F83VFHZ) during operation.	<ul style="list-style-type: none"> Check around outdoor unit. Check outdoor unit air passage. Refer to 12-6. ㊦ "Check of outdoor fan motor". 	—
	P.C. board temperature	4 times	Not lit	The P.C. board temperature exceeds 67°C (MXZ-3F54/3F68/4F72VF/VF2/VF3/4F80VF2/VF3/4F83/5F102VF, MXZ-2F53VFHZ)/87°C (MXZ-6F122VF, MXZ-4F83VFHZ) during operation.		
8-time blink	Outdoor fan motor	Lit	Lit	A failure occurs 3 consecutive times within 30 seconds after the fan gets started.	<ul style="list-style-type: none"> Refer to 12-6. ㊦ "Check of outdoor fan motor". 	—
9-time blink	Outdoor control system	Lit	5 times	Nonvolatile memory data cannot be read properly.	<ul style="list-style-type: none"> Replace the outdoor control P.C. board. 	○
10-time blink	Low discharge temperature protection	Lit	Lit	The frequency of the compressor is kept 80 Hz or more and the discharge temperature is kept under 39°C for more than 20 minutes.	<ul style="list-style-type: none"> Check refrigerant circuit and refrigerant amount. Refer to 12-6. ㊦ "Check of LEV". 	—
11-time blink	Communication error between P.C. boards	Lit	6 times	Communication error occurs between the outdoor control P.C. board and outdoor power P.C. board for more than 10 seconds.	<ul style="list-style-type: none"> Check the connecting wire between outdoor control P.C. board and outdoor power P.C. board. 	—
				The communication between boards protection cut-out operates 2 consecutive times.		○
	Current sensor	Lit	7 times	A short or open circuit is detected in the current sensor during compressor operating.	—	—
				Current sensor protection cut-out operates 2 consecutive times.		○
	Zero cross detecting circuit	5 times	Not lit	Zero cross signal cannot be detected while the compressor is operating.	<ul style="list-style-type: none"> Check the connecting wire among outdoor control P.C. board and outdoor power P.C. board. 	—
				The protection cut-out of the zero cross detecting circuit operates 10 consecutive times.		○
Converter	5 times	Not lit	A failure is detected in the operation of the converter during operation.	<ul style="list-style-type: none"> Check the voltage of power supply. Replace the outdoor power P.C. board. 	—	
Bus-bar voltage	5 times	Not lit	The bus-bar voltage exceeds 400 V or falls to low level during compressor operating.	<ul style="list-style-type: none"> Check the voltage of power supply. Replace the outdoor control P.C. board. 	—	



The left lamp of OPERATION INDICATOR lamp (Indoor unit)	Abnormal point (Failure mode/protection)	LED indication (Outdoor P.C. board)		Condition	Remedy	Indoor/outdoor unit failure mode recall function
		LED1	LED2			
14-time blink	Refrigerant leakage (Sensor detection)	Lit	Lit	1.Refrigerant leaks from the piping or the heat exchanger in the indoor unit. 2.The following items are used around the indoor unit. <ul style="list-style-type: none"> • Spray (LP gas including Freon, and whose main ingredient is propane and butane) • Aerosol insecticide (including ethanol) • Air spray painting (including dichloromethane) • Charcoal (charcoal fire) • Chemicals (such as ethanol) 	<ul style="list-style-type: none"> • Turn off the power after the indoor unit finishes its FAN operation. (The FAN operation continues for 3 hours.) • Check the indoor unit to detect the part where refrigerant leaks. • Repair the part where refrigerant leaks. • Turn on the power again. • Replace the refrigerant sensor if the problem is not fixed. 	○
14-time blink	Refrigerant leakage (Sensor detection)	Lit	Lit	The refrigerant sensor mounted on the indoor unit does not work. The refrigerant sensor is not connected properly or the wire is broken.	<ul style="list-style-type: none"> • Connect the connector of the refrigerant sensor properly. • Replace the refrigerant sensor. 	○
	Incompatible unit combination	Lit	11 times	The indoor unit which is not compatible with the outdoor unit is connected.	<ul style="list-style-type: none"> • Replace the indoor unit with the one which is compatible with the outdoor unit. 	○
15-time blink	LEV and drain pump	Lit	Lit	The indoor unit detects an abnormality in the LEV and drain pump.	<ul style="list-style-type: none"> • Refer to 12-6. © "Check of LEV". • Check the drain pump of the indoor unit. 	—

12-3. INSTRUCTION OF TROUBLESHOOTING

- Check the indoor unit referring to the indoor unit service manual, and confirm that there is any problem in the indoor unit. Then, check the outdoor unit with referring to this page.

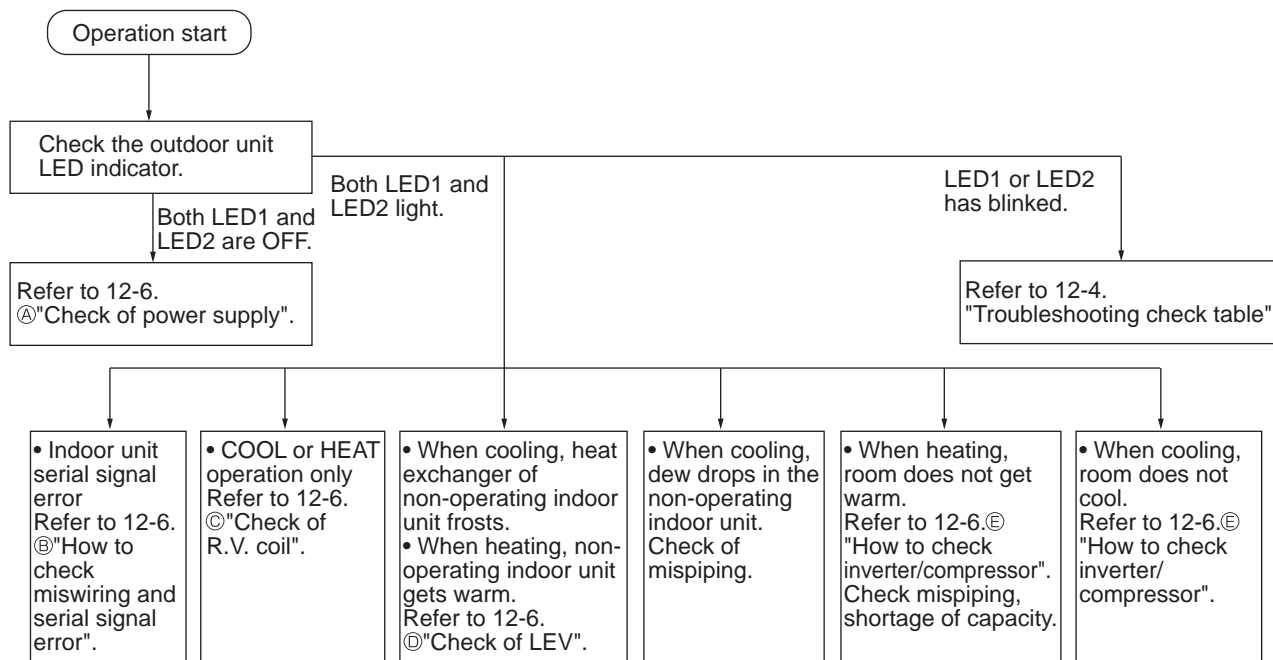

12-4. TROUBLESHOOTING CHECK TABLE

MXZ-2F33/42/53VF/VF2/VF3, MXZ-2F53VFH/VFH2/VFH3

No.	Symptom	Indication		Abnormal point / Condition	Condition	Remedy
		LED1(Red)	LED2(Yellow)			
1	Outdoor unit does not operate.	Lit	Once	LEV and drain pump	The indoor unit detects an abnormality in the LEV and drain pump.	<ul style="list-style-type: none"> Refer to 12-6. ㉔ "Check of LEV". Check the drain pump of the indoor unit.
2		Lit	Twice	Outdoor power system	Overcurrent protection cut-out operates 3 consecutive times within 1 minute after the compressor gets started.	<ul style="list-style-type: none"> Check the connection of the compressor connecting wire. Refer to 12-6. ㉕ "How to check inverter/compressor". Check the stop valve.
3		Lit	3 times	Discharge temperature thermistor	A short circuit is detected in the thermistor during operation, or when an open circuit is detected in the thermistor after 10 minutes of compressor startup.	<ul style="list-style-type: none"> Refer to 12-6. ㉖ "Check of outdoor thermistors".
4		Lit	4 times	Fin temperature thermistor	A short or open circuit is detected in the thermistor during operation.	<ul style="list-style-type: none"> Refer to 12-6. ㉖ "Check of outdoor thermistors".
				P.C board temperature thermistor		<ul style="list-style-type: none"> Replace the inverter P.C. board.
5		Lit	5 times	Ambient temperature thermistor	A short or open circuit is detected in the thermistor during operation.	<ul style="list-style-type: none"> Refer to 12-6. ㉖ "Check of outdoor thermistors".
				Outdoor heat exchanger temperature thermistor	A short circuit is detected in the thermistor during operation, or when an open circuit is detected in the thermistor after 5 minutes (in cooling) and 10 minutes (in heating) of compressor startup.	
				Defrost thermistor	A short circuit is detected in the thermistor during operation, or when an open circuit is detected in the thermistor after 5 minutes of compressor startup.	
6		Lit	7 times	Nonvolatile memory data	The nonvolatile memory data cannot be read properly.	<ul style="list-style-type: none"> Replace the inverter P.C. board.
7		Lit	11 times	Stop valve Closed valve	Closed valve is detected by compressor current. (MXZ-2F33VF, MXZ-2F33VF2, MXZ-2F33VF3)	<ul style="list-style-type: none"> Check the stop valve.
8		Lit	17 times	Outdoor refrigerant system abnormality	A closed valve and air trapped in the refrigerant circuit are detected based on the temperature sensed by the indoor and outdoor thermistors and the current of the compressor.	<ul style="list-style-type: none"> Check for a gas leak in a connecting piping etc. Check the stop valve. Refer to 12-6. ㉗ "Check of outdoor refrigerant circuit".
9	Lit	18 times	Detection of refrigerant (Indoor unit)	<ol style="list-style-type: none"> Refrigerant leaks from the piping or the heat exchanger in the indoor unit. The following items are used around the indoor unit. <ul style="list-style-type: none"> Spray (LP gas including Freon, and whose main ingredient is propane and butane) Aerosol insecticide (including ethanol) Air spray painting (including dichloromethane) Charcoal (charcoal fire) Chemicals (such as ethanol) 	<ul style="list-style-type: none"> Turn off the power after the indoor unit finishes its fan operation. (The fan operation continues for 3 hours.) Check the indoor unit to detect the part where refrigerant leaks. Repair the part where refrigerant leaks. Turn on the power again. Replace the refrigerant sensor if the problem is not fixed. 	
10	Lit	19 times	Abnormality of refrigerant leakage sensor (Indoor unit)	The refrigerant sensor mounted on the indoor unit does not work. The refrigerant sensor is not connected properly or the wire is broken.	<ul style="list-style-type: none"> Connect the connector of the refrigerant sensor properly. Replace the refrigerant sensor. 	
11	Lit	20 times	Incompatible unit combination error	The indoor unit which is not compatible with the outdoor unit is connected.	<ul style="list-style-type: none"> Replace the indoor unit with the one which is compatible with the outdoor unit. 	
12	'Outdoor unit stops and restarts 3 minutes later' is repeated.	Twice	Not lit	Overcurrent	14 A (MXZ-2F33VF, MXZ-2F33VF2, MXZ-2F33VF3)/18 A (MXZ-2F42VF, MXZ-2F42VF2, MXZ-2F42VF3, MXZ-2F53VF/VFH, MXZ-2F53VF2/VFH2, MXZ-2F53VF3/VFH3) current flows into intelligent power module.	<ul style="list-style-type: none"> Reconnect compressor connector. Refer to 12-6. ㉕ "How to check inverter/compressor". Check the stop valve.
13		3 times	Not lit	Discharge temperature protection	Discharge temperature exceeds 116°C during operation. Compressor can restart if discharge temperature thermistor reads 100°C or less 3 minutes later.	<ul style="list-style-type: none"> Check the amount of gas and the refrigerant circuit. Refer to 12-6. ㉔ "Check of LEV".
14		4 times	Not lit	Fin temperature protection	The fin temperature exceeds 90°C during operation.	<ul style="list-style-type: none"> Check the refrigerant circuit and the refrigerant amount.
				P.C. board temperature protection	The P.C. board temperature exceeds 78°C during operation.	<ul style="list-style-type: none"> Refer to 12-6. ㉔ "Check of outdoor fan motor".
15		5 times	Not lit	High pressure protection	The outdoor heat exchanger temperature exceeds 70°C during cooling or indoor gas pipe temperature exceeds 70°C during heating.	<ul style="list-style-type: none"> Check the amount of gas and the refrigerant circuit. Check the stop valve.
16		9 times	Not lit	Bus-bar voltage protection	The bus-bar voltage exceeds 430 V or falls to 50 V or below during compressor operating.	<ul style="list-style-type: none"> Replace the inverter P.C. board.
17		13 times	Not lit	Outdoor fan motor	Failure occurs 3 consecutive times within 30 seconds after the fan gets started.	<ul style="list-style-type: none"> Refer to 12-6. ㉔ "Check of outdoor fan motor".
18		8 times	Not lit	Current sensor protection	A short or open circuit is detected in the current sensor during compressor operating.	<ul style="list-style-type: none"> Replace the inverter P.C. board.
19		10 times	Not lit	Compressor	The compressor does not synchronize with the operating power.	<ul style="list-style-type: none"> Reconnect compressor connector. Refer to 12-6. ㉕ "How to check inverter/compressor". Check the stop valve.



No.	Symptom	Indication		Abnormal point / Condition	Condition	Remedy
		LED1(Red)	LED2(Yellow)			
20	Outdoor unit operates.	Once	Lit	Primary current protection	The input current exceeds 8 A (MXZ-2F33VF, MXZ-2F33VF2, MXZ-2F33VF3)/ 10 A (MXZ-2F42VF, MXZ-2F42VF2, MXZ-2F42VF3, MXZ-2F53VF/VFH, MXZ-2F53VF2/VFH2, MXZ-2F53VF3/VFH3).	These symptoms do not mean any abnormality of the product, but check the following points. <ul style="list-style-type: none"> • Check if indoor filters are clogged. • Check if refrigerant is short. • Check if indoor/outdoor unit air circulation is short cycled.
				Secondary current protection	The current of the compressor exceeds 17 A.	
21	Twice	Lit	High pressure protection	The indoor gas pipe temperature exceeds 45°C during heating.		
			Defrosting in cooling	The indoor gas pipe temperature falls 3°C or below during cooling.		
22	3 times	Lit	Discharge temperature protection	The discharge temperature exceeds 100°C during operation.	<ul style="list-style-type: none"> • Check the refrigerant circuit and the refrigerant amount. • Refer to 12-6. Ⓞ "Check of LEV". • Refer to 12-6. Ⓞ "Check of outdoor thermistors". 	
23	4 times	Lit	Low discharge temperature protection	The frequency of the compressor is kept 68 Hz (MXZ-2F33VF, MXZ-2F33VF2, MXZ-2F33VF3)/80 Hz (MXZ-2F42VF, MXZ-2F42VF2, MXZ-2F42VF3, MXZ-2F53VF/VFH, MXZ-2F53VF2/VFH2, MXZ-2F53VF3/VFH3) or more and the discharge temperature is kept under 50°C (COOL mode)/40°C (HEAT mode) for more than 40 minutes.	<ul style="list-style-type: none"> • Refer to 12-6. Ⓞ "Check of LEV". • Check the refrigerant circuit and the refrigerant amount. 	
24	5 times	Lit	Cooling high pressure protection	The outdoor heat exchanger temperature exceeds 58°C during operation.	This symptom does not mean any abnormality of the product, but check the following points. <ul style="list-style-type: none"> • Check if indoor filters are clogged. • Check if refrigerant is short. • Check if indoor/outdoor unit air circulation is short cycled. 	
25	8 times	Lit	Converter protection	A failure is detected in the operation of the converter during operation.	<ul style="list-style-type: none"> • Check the voltage of power supply. • Replace the inverter P.C. board. 	
26	Outdoor unit operates normally.	9 times	Lit	Inverter check mode	The connector of compressor is disconnected. Inverter check mode starts.	—
27		Lit	Lit	Normal	—	—

NOTE 1. The location of LED is illustrated at the right figure. Refer to 12-7.4.

2. LED is lighted during normal operation.

The blinking frequency shows the number of times the LED blinks after every 2.5-second OFF.
 (Example) When the blinking frequency is "2".

Outdoor display P.C. board (Parts side)

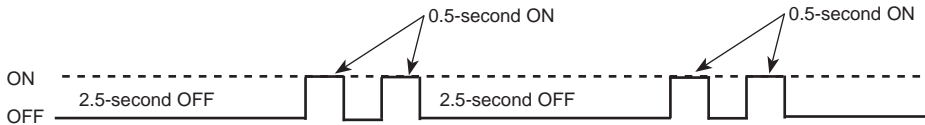

MXZ-3F, 4F, 5F, 6F, MXZ-2F53VFHZ, MXZ-4F83VFHZ

No.	Symptom	Indication		Abnormal point / Condition	Condition	Remedy
		LED1(Red)	LED2(Yellow)			
1	Outdoor unit does not operate.	Lit	Once	LEV and drain pump	The indoor unit detects an abnormality in the LEV and drain pump.	<ul style="list-style-type: none"> Refer to 12-6. ④ "Check of LEV". Check the drain pump of the indoor unit.
2		Lit	Twice	Outdoor power system	Overcurrent protection cut-out operates 3 consecutive times within 1 minute after the compressor gets started, or converter protection cut-out or bus-bar voltage protection cut-out operates 3 consecutive times within 3 minutes after startup.	<ul style="list-style-type: none"> Check the connection of the compressor connecting wire. Refer to 12-6. ④ "How to check inverter/compressor". Check the stop valve.
3		Lit	3 times	Discharge temperature thermistor	A short circuit is detected in the thermistor during operation, or an open circuit is detected in the thermistor after 10 minutes of compressor startup.	<ul style="list-style-type: none"> Refer to 12-6. ⑤ "Check of outdoor thermistors".
4		Lit	4 times	Fin temperature thermistor	A short or open circuit is detected in the thermistor during operation.	<ul style="list-style-type: none"> Refer to 12-6. ⑤ "Check of outdoor thermistors".
				P. C. board temperature thermistor		<ul style="list-style-type: none"> Replace the outdoor control P.C. board.
5		Lit	5 times	Ambient temperature thermistor	A short or open circuit is detected in the thermistor during operation.	<ul style="list-style-type: none"> Refer to 12-6. ⑤ "Check of outdoor thermistors".
				Outdoor heat exchanger temperature thermistor	A short circuit is detected in the thermistor during operation, or an open circuit is detected in the thermistor after 5 minutes (in cooling) and 10 minutes (in heating) of compressor startup.	
				Defrost thermistor	A short circuit is detected in the thermistor during operation, or an open circuit is detected in the thermistor after 5 minutes of compressor startup.	
6		Lit	6 times	Zero cross detecting circuit (Outdoor control P.C. board)	Zero cross signal cannot be detected.	<ul style="list-style-type: none"> Replace the outdoor control P.C. board.
7		Lit	7 times	Outdoor control system	The nonvolatile memory data cannot be read properly.	<ul style="list-style-type: none"> Replace the outdoor control P.C. board.
8		Lit	8 times	Current sensor	Current sensor protection cut-out operates 2 consecutive times.	<ul style="list-style-type: none"> Replace the outdoor power P.C. board.
9		Lit	11 times	Communication error between P.C. boards	The communication protection cut-out between boards operates 2 consecutive times.	<ul style="list-style-type: none"> Check the connecting wire between outdoor control P.C. board and outdoor power P.C. board.
				M-NET communication error	M-NET adapter P.C. board detects an abnormality in the communication error.	<ul style="list-style-type: none"> Check the connecting wire between M-NET adapter P.C. board and outdoor control P.C. board, or terminal block.
10		Lit	12 times	Zero cross detecting circuit (Outdoor power P.C. board)	The protection cut-out of the zero cross detecting circuit operates 10 consecutive times.	<ul style="list-style-type: none"> Replace the outdoor power P.C. board.
11		Lit	13 times	Current sensor	A short or open circuit is detected in the input current detection circuit during operation.	<ul style="list-style-type: none"> Replace the outdoor power P.C. board.
12	Lit	14 times	Voltage sensor	A short or open circuit is detected in the input voltage detection circuit during operation.	<ul style="list-style-type: none"> Replace the outdoor power P.C. board. 	
13	Lit	15 times	Relay operation	No relay operation is detected during operation.	<ul style="list-style-type: none"> Replace the outdoor power P.C. board. 	
14	Lit	18 times	Detection of refrigerant (Indoor unit)	<ol style="list-style-type: none"> Refrigerant leaks from the piping or the heat exchanger in the indoor unit. The following items are used around the indoor unit. <ul style="list-style-type: none"> Spray (LP gas including Freon, and whose main ingredient is propane and butane) Aerosol insecticide (including ethanol) Air spray painting (including dichloromethane) Charcoal (charcoal fire) Chemicals (such as ethanol) 	<ul style="list-style-type: none"> Turn off the power after the indoor unit finishes its fan operation. (The fan operation continues for 3 hours.) Check the indoor unit to detect the part where refrigerant leaks. Repair the part where refrigerant leaks. Turn on the power again. Replace the refrigerant sensor if the problem is not fixed. 	
15	Lit	19 times	Abnormality of refrigerant leakage sensor (Indoor unit)	The refrigerant sensor mounted on the indoor unit does not work. The refrigerant sensor is not connected properly or the wire is broken.	<ul style="list-style-type: none"> Connect the connector of the refrigerant sensor properly. Replace the refrigerant sensor. 	
16	Lit	20 times	Incompatible unit combination error	The indoor unit which is not compatible with the outdoor unit is connected.	<ul style="list-style-type: none"> Replace the indoor unit with the one which is compatible with the outdoor unit. 	
17	'Outdoor unit stops and restarts 3 minutes later' is repeated.	Twice	Not lit	IPM protection	Overcurrent is detected after 30 seconds of compressor startup.	<ul style="list-style-type: none"> Reconnect compressor connector. Refer to 12-6. ④ "How to check inverter/compressor". Check the stop valve. Check the power module (PAM module).
				Lock protection	Overcurrent is detected within 30 seconds of compressor startup.	
18		3 times	Not lit	Discharge temperature protection	The discharge temperature exceeds 115°C (MXZ-3F54/3F68/4F72VF/VF2/VF3/4F80VF2/VF3)/106°C (MXZ-4F83/5F102VF, MXZ-2F53VFHZ)/116°C (MXZ-6F122VF, MXZ-4F83VFHZ) during operation. Compressor can restart if discharge temperature thermistor reads 80°C (MXZ-3F54/3F68/4F72VF/VF2/VF3/4F80VF2/VF3)/95°C (MXZ-4F83/5F102VF, MXZ-2F53VFHZ)/100°C (MXZ-6F122VF, MXZ-4F83VFHZ) or less 3 minutes later.	
19	4 times	Not lit	Fin temperature protection	The fin temperature exceeds during operation.	<ul style="list-style-type: none"> Check refrigerant circuit and refrigerant amount. Refer to 12-6. ④ "Check of outdoor fan motor". 	
			P.C. board temperature protection	The P.C. board temperature exceeds during operation.		



No.	Symptom	Indication		Abnormal point / Condition	Condition	Remedy
		LED1(Red)	LED2(Yellow)			
20	'Outdoor unit stops and restarts 3 minutes later' is repeated.	5 times	Not lit	High pressure protection	High pressure is detected with the high pressure switch (HPS) during operation. The outdoor heat exchanger temperature exceeds 70°C during cooling or the indoor gas pipe temperature exceeds 70°C during heating.	<ul style="list-style-type: none"> • Check around of gas and the refrigerant circuit. • Check the stop valve.
21		6 times	Not lit	Pre-heating protection	Overcurrent is detected during pre-heating.	<ul style="list-style-type: none"> • Reconnect compressor connector. • Refer to 12-6.Ⓒ "How to check inverter/compressor". • Check the power module.
22		8 times	Not lit	Converter protection	A failure is detected in the operation of the converter during operation.	<ul style="list-style-type: none"> • Replace the outdoor power P.C. board.
23		9 times	Not lit	Bus-bar voltage protection	The bus-bar voltage exceeds 400 V or falls to low level during compressor operating.	<ul style="list-style-type: none"> • Check the voltage of power supply. • Replace the outdoor power P.C. board or the outdoor control P.C. board. • Refer to 12-6. Ⓓ "Check of bus-bar voltage".
24		11 times	Not lit	Low outside temperature protection(cooling)	The ambient became -12°C or less.	—
25		13 times	Not lit	Outdoor fan motor	A failure occurs 3 consecutive times within 30 seconds after the fan gets started.	<ul style="list-style-type: none"> • Refer to 12-6. Ⓔ "Check of outdoor fan motor".
26		Lit	8 times	Current sensor protection	A short or open circuit is detected in the current sensor during compressor operating.	<ul style="list-style-type: none"> • Replace the outdoor power P.C. board.
27		Lit	11 times	Communication between P.C. boards protection	Communication error occurs between the outdoor control P.C. board and outdoor power P.C. board for more than 10 seconds.	<ul style="list-style-type: none"> • Check the connecting wire between outdoor control P.C. board and outdoor power P.C. board.
28		Lit	12 times	Zero cross detecting circuit (Outdoor power P.C. board)	Zero cross signal cannot be detected while the compressor is operating.	<ul style="list-style-type: none"> • Replace the outdoor power P.C. board.
29	Outdoor unit operates.	Once	Lit	Primary current protection	The input current exceeds 13.6 A (MXZ-2F53VFHZ)/15 A (MXZ-3F54/3F68/4F72VF/VF2/VF3/4F80VF2/VF3)/18.4 A (MXZ-4F83/5F102VF)/26.8A(MXZ-6F122VF)/25 A (MXZ-4F83VFHZ).	<ul style="list-style-type: none"> • These symptoms do not mean any abnormality of the product, but check the following points. • Check if indoor filters are clogged. • Check if refrigerant is short. • Check if indoor/outdoor unit air circulation is short cycled.
30		Twice	Lit	High pressure protection	The indoor gas pipe temperature exceeds 45°C during heating.	<ul style="list-style-type: none"> • Check if indoor/outdoor unit air circulation is short cycled.
				Defrosting in cooling	The indoor gas pipe temperature falls 3°C or below during cooling.	
31		3 times	Lit	Discharge temperature protection	The frequency of the compressor is kept 80 Hz or more and the discharge temperature is kept under 50°C(COOL mode)/40°C(HEAT mode) for more than 40 minutes.	<ul style="list-style-type: none"> • Check refrigerant circuit and refrigerant amount. • Refer to 12-6. Ⓒ "Check of LEV". • Refer to 12-6. Ⓔ "Check of outdoor thermistors".
32		4 times	Lit	Low discharge temperature protection	The frequency of the compressor is kept 80 Hz or more and the discharge temperature is kept under 39°C for more than 20 minutes.	<ul style="list-style-type: none"> • Refer to 12-6. Ⓒ "Check of LEV". • Check refrigerant circuit and refrigerant amount.
33		5 times	Lit	Cooling high pressure protection	The outdoor heat exchanger temperature exceeds 58°C during operation.	<ul style="list-style-type: none"> • This symptom does not mean any abnormality of the product, but check the following points. • Check if indoor filters are clogged. • Check if refrigerant is short. • Check if indoor/outdoor unit air circulation is short cycled.
34		7 times	Lit	High → Low Pressure bypass valve Cooling evaporating temperature drop prevention control	MXZ-MXZ-3F54/3F68/4F72VF/VF2/VF3/4F80VF2/VF3 During cooling operation, the temperature of indoor heat exchanger becomes 3°C or less within 1 hour after the compressor starts running, or it becomes less than 12°C - 16°C* later than that. * It depends on the difference between the set temperature and the room temperature.	<ul style="list-style-type: none"> • This symptom does not mean any abnormality of the product, but check the following points. • Check the indoor filters are not clogged. • Check there is sufficient refrigerant. • Check the indoor/outdoor unit air circulation is not short cycled.
			High → Low pressure bypass valve High pressure protection control at startup of heating operation	MXZ-6F122VF, MXZ-4F83VFHZ The room temperature is 24°C or more when 1 or 2 unit(s) start(s) the heating operation.		
			High → Low pressure bypass valve Compressor oil tempering control at startup of heating operation	MXZ-6F122VF, MXZ-4F83VFHZ Both the following are true: • The outside temperature is -2°C or less when the heating operation is started. • [(Discharge temperature) - (Indoor heat exchanger temperature)] < 5°C		
35	11 times	Lit	M-NET communication error	M-NET adapter P.C. board detects an abnormality in the communication error.	<ul style="list-style-type: none"> • Check the connecting wire between M-NET adapter P.C. board and outdoor control P.C. board, or terminal block. 	



No.	Symptom	Indication		Abnormal point / Condition	Condition	Remedy	
		LED1(Red)	LED2(Yellow)				
36	Outdoor unit operates normally.	8 times	Lit	Cooling evaporating temperature protection	During cooling operation, the temperature of indoor heat exchanger becomes 7°C - 11°C* or less within 1 hour after the compressor starts running, or it becomes 9°C - 17°C* or less later than that. * It depends on the indoor unit type/model or the difference between the set temperature and the room temperature.	This symptom does not mean any abnormality of the product.	
37		9 times	Lit	Inverter check mode	The unit is operated with emergency operation switch.		—
38		Lit	Lit	Normal	—		—

NOTE 1. The location of LED is illustrated at the right figure. Refer to 12-7.2.

2. LED is lighted during normal operation.

The blinking frequency shows the number of times the LED blinks after every 2.5-second OFF.
(Example) When the blinking frequency is "2".

Outdoor control
P.C. board
(Parts side)

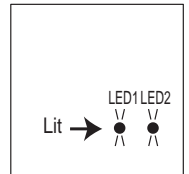
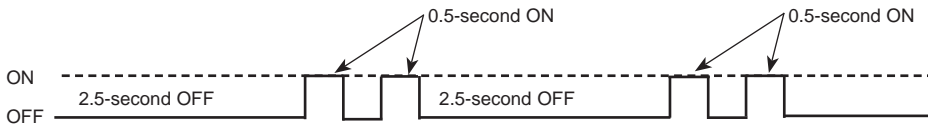

12-5. TROUBLE CRITERION OF MAIN PARTS

MXZ-2F33VF MXZ-2F42VF MXZ-2F53VF MXZ-2F53VFH
MXZ-2F33VF2 MXZ-2F42VF2 MXZ-2F53VF2 MXZ-2F53VFH2
MXZ-2F33VF3 MXZ-2F42VF3 MXZ-2F53VF3 MXZ-2F53VFH3
MXZ-3F54VF MXZ-3F68VF MXZ-4F72VF
MXZ-3F54VF2 MXZ-3F68VF2 MXZ-4F72VF2 MXZ-4F80VF2
MXZ-3F54VF3 MXZ-3F68VF3 MXZ-4F72VF3 MXZ-4F80VF3
MXZ-4F83VF MXZ-5F102VF MXZ-6F122VF
MXZ-2F53VFHZ MXZ-4F83VFHZ

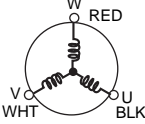
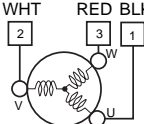
Part name	Check method and criterion															
Defrost thermistor (RT61) Fin temperature thermistor (RT64) Ambient temperature thermistor (RT65) Outdoor heat exchanger temperature thermistor (RT68)	Measure the resistance with a tester. Refer to 12-7. "TEST POINT DIAGRAM AND VOLTAGE" 1. "Inverter P.C. board", 2. "Outdoor control P.C. board " or 3. "Outdoor power P.C. board" for the chart of thermistor.															
Discharge temperature thermistor (RT62)	Measure the resistance with a tester. Before measurement, hold the thermistor with your hands to warm it up. Refer to 12-7. "TEST POINT DIAGRAM AND VOLTAGE" 1. "Inverter P.C. board", 2. "Outdoor control P.C. board ", for the chart of thermistor.															
Compressor 	Measure the resistance between terminals with a tester. (Winding temperature : -10°C - 40°C) <table border="1" style="width: 100%; text-align: center;"> <thead> <tr> <th colspan="3">Normal (Each phase)</th> </tr> </thead> <tbody> <tr> <td style="width: 33%;">MXZ-2F33VF/VF2/VF3</td> <td style="width: 33%;">MXZ-2F42VF/VF2/VF3 MXZ-2F53VF/VF2/VF3 MXZ-2F53VFH/VFH2/VFH3 MXZ-3F54VF/VF2/VF3</td> <td style="width: 33%;">MXZ-3F68VF/VF2/VF3 MXZ-4F72VF/VF2/VF3 MXZ-4F80VF2/VF3</td> </tr> <tr> <td>1.59 Ω - 2.16Ω</td> <td>0.86 Ω - 1.06 Ω</td> <td>0.91 Ω - 1.13 Ω</td> </tr> </tbody> </table> <table border="1" style="width: 100%; text-align: center;"> <thead> <tr> <th colspan="2">Normal (Each phase)</th> </tr> </thead> <tbody> <tr> <td style="width: 50%;">MXZ-4F83VF MXZ-5F102VF MXZ-2F53VFHZ</td> <td style="width: 50%;">MXZ-6F122VF MXZ-4F83VFHZ</td> </tr> <tr> <td>0.83 Ω - 1.03Ω</td> <td>0.77 Ω - 0.95 Ω</td> </tr> </tbody> </table>	Normal (Each phase)			MXZ-2F33VF/VF2/VF3	MXZ-2F42VF/VF2/VF3 MXZ-2F53VF/VF2/VF3 MXZ-2F53VFH/VFH2/VFH3 MXZ-3F54VF/VF2/VF3	MXZ-3F68VF/VF2/VF3 MXZ-4F72VF/VF2/VF3 MXZ-4F80VF2/VF3	1.59 Ω - 2.16Ω	0.86 Ω - 1.06 Ω	0.91 Ω - 1.13 Ω	Normal (Each phase)		MXZ-4F83VF MXZ-5F102VF MXZ-2F53VFHZ	MXZ-6F122VF MXZ-4F83VFHZ	0.83 Ω - 1.03Ω	0.77 Ω - 0.95 Ω
Normal (Each phase)																
MXZ-2F33VF/VF2/VF3	MXZ-2F42VF/VF2/VF3 MXZ-2F53VF/VF2/VF3 MXZ-2F53VFH/VFH2/VFH3 MXZ-3F54VF/VF2/VF3	MXZ-3F68VF/VF2/VF3 MXZ-4F72VF/VF2/VF3 MXZ-4F80VF2/VF3														
1.59 Ω - 2.16Ω	0.86 Ω - 1.06 Ω	0.91 Ω - 1.13 Ω														
Normal (Each phase)																
MXZ-4F83VF MXZ-5F102VF MXZ-2F53VFHZ	MXZ-6F122VF MXZ-4F83VFHZ															
0.83 Ω - 1.03Ω	0.77 Ω - 0.95 Ω															
Outdoor fan motor  MXZ-2F33VF/VF2/VF3 MXZ-2F42VF/VF2/VF3 MXZ-2F53VF/VF2/VF3 MXZ-2F53VFH/VFH2/VFH3	Measure the resistance between lead wires with a tester. (Part temperature : -10°C - 40°C) <table border="1" style="width: 100%; text-align: center;"> <thead> <tr> <th colspan="2">Normal (Each phase)</th> </tr> </thead> <tbody> <tr> <td colspan="2">MXZ-2F33VF/42VF/53VF/53VFH</td> </tr> <tr> <td colspan="2">12 Ω - 16 Ω</td> </tr> </tbody> </table> <table border="1" style="width: 100%; text-align: center;"> <tbody> <tr> <td colspan="2">MXZ-2F33VF2/42VF2/53VF2/53VFH2 MXZ-2F33VF3/42VF3/53VF3/53VFH3</td> </tr> <tr> <td colspan="2">32 Ω - 43 Ω</td> </tr> </tbody> </table>	Normal (Each phase)		MXZ-2F33VF/42VF/53VF/53VFH		12 Ω - 16 Ω		MXZ-2F33VF2/42VF2/53VF2/53VFH2 MXZ-2F33VF3/42VF3/53VF3/53VFH3		32 Ω - 43 Ω						
Normal (Each phase)																
MXZ-2F33VF/42VF/53VF/53VFH																
12 Ω - 16 Ω																
MXZ-2F33VF2/42VF2/53VF2/53VFH2 MXZ-2F33VF3/42VF3/53VF3/53VFH3																
32 Ω - 43 Ω																
Outdoor fan motor MXZ-3F54VF/VF2/VF3 MXZ-3F68VF/VF2/VF3 MXZ-4F72VF/VF2/VF3 MXZ-4F80VF2/VF3 MXZ-4F83VF MXZ-5F102VF MXZ-6F122VF MXZ-2F53VFHZ MXZ-4F83VFHZ	Refer to 12-6. ㉔.															

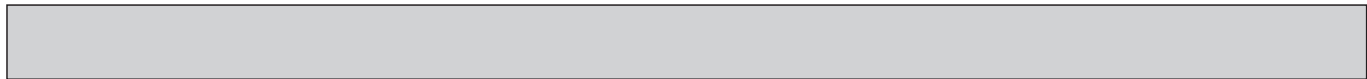

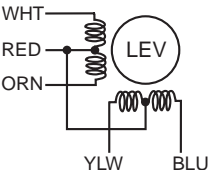
Part name	Check method and criterion																						
R.V. coil	Measure the resistance with a tester. (Part temperature : -10°C - 40°C) <table border="1" data-bbox="571 309 1093 488"> <thead> <tr> <th colspan="2">Normal</th> </tr> </thead> <tbody> <tr> <td>MXZ-2F33VF/VF2/VF3</td> <td>MXZ-3F54VF/VF2/VF3</td> </tr> <tr> <td>MXZ-2F42VF/VF2/VF3</td> <td>MXZ-3F68VF/VF2/VF3</td> </tr> <tr> <td>MXZ-2F53VF/VF2/VF3</td> <td>MXZ-4F72VF/VF2/VF3</td> </tr> <tr> <td>MXZ-2F53VFH/VFH2/VFH3</td> <td>MXZ-4F80VF2/VF3</td> </tr> <tr> <td>1.20 kΩ - 1.56 kΩ</td> <td>1.26 kΩ - 1.62 kΩ</td> </tr> </tbody> </table> <table border="1" data-bbox="571 495 979 631"> <thead> <tr> <th colspan="2">Normal</th> </tr> </thead> <tbody> <tr> <td>MXZ-4F83VF</td> <td>MXZ-6F122VF</td> </tr> <tr> <td>MXZ-5F102VF</td> <td>MXZ-4F83VFHZ</td> </tr> <tr> <td>MXZ-2F53VFHZ</td> <td></td> </tr> <tr> <td>1.20 kΩ - 1.77 kΩ</td> <td>1.24 kΩ - 1.86 kΩ</td> </tr> </tbody> </table>	Normal		MXZ-2F33VF/VF2/VF3	MXZ-3F54VF/VF2/VF3	MXZ-2F42VF/VF2/VF3	MXZ-3F68VF/VF2/VF3	MXZ-2F53VF/VF2/VF3	MXZ-4F72VF/VF2/VF3	MXZ-2F53VFH/VFH2/VFH3	MXZ-4F80VF2/VF3	1.20 kΩ - 1.56 kΩ	1.26 kΩ - 1.62 kΩ	Normal		MXZ-4F83VF	MXZ-6F122VF	MXZ-5F102VF	MXZ-4F83VFHZ	MXZ-2F53VFHZ		1.20 kΩ - 1.77 kΩ	1.24 kΩ - 1.86 kΩ
Normal																							
MXZ-2F33VF/VF2/VF3	MXZ-3F54VF/VF2/VF3																						
MXZ-2F42VF/VF2/VF3	MXZ-3F68VF/VF2/VF3																						
MXZ-2F53VF/VF2/VF3	MXZ-4F72VF/VF2/VF3																						
MXZ-2F53VFH/VFH2/VFH3	MXZ-4F80VF2/VF3																						
1.20 kΩ - 1.56 kΩ	1.26 kΩ - 1.62 kΩ																						
Normal																							
MXZ-4F83VF	MXZ-6F122VF																						
MXZ-5F102VF	MXZ-4F83VFHZ																						
MXZ-2F53VFHZ																							
1.20 kΩ - 1.77 kΩ	1.24 kΩ - 1.86 kΩ																						
Linear expansion valve 	Measure the resistance with a tester. (Part temperature : -10°C - 40°C) <table border="1" data-bbox="571 696 1227 848"> <thead> <tr> <th>Color of lead wire</th> <th>Normal</th> </tr> </thead> <tbody> <tr> <td>WHT - RED</td> <td rowspan="4">37.4 Ω - 53.9 Ω</td> </tr> <tr> <td>RED - ORN</td> </tr> <tr> <td>YLW - RED</td> </tr> <tr> <td>RED - BLU</td> </tr> </tbody> </table>	Color of lead wire	Normal	WHT - RED	37.4 Ω - 53.9 Ω	RED - ORN	YLW - RED	RED - BLU															
Color of lead wire	Normal																						
WHT - RED	37.4 Ω - 53.9 Ω																						
RED - ORN																							
YLW - RED																							
RED - BLU																							
High pressure switch (HPS) MXZ-3F54VF/VF2/VF3 MXZ-3F68VF/VF2/VF3 MXZ-4F72VF/VF2/VF3 MXZ-4F80VF2/VF3 MXZ-4F83VF MXZ-5F102VF MXZ-6F122VF MXZ-2F53VFHZ MXZ-4F83VFHZ	<table border="1" data-bbox="571 904 1251 1140"> <thead> <tr> <th colspan="2">Pressure</th> <th>Normal</th> </tr> </thead> <tbody> <tr> <td></td> <td> MXZ-3F54VF/VF2/VF3 MXZ-4F83VF MXZ-3F68VF/VF2/VF3 MXZ-5F102VF MXZ-4F72VF/VF2/VF3 MXZ-6F122VF MXZ-4F80VF2/VF3 MXZ-2F53VFHZ MXZ-4F83VFHZ </td> <td>Normal</td> </tr> <tr> <td>HPS</td> <td>3.14 ± 0.15 MPa</td> <td>Close</td> </tr> <tr> <td></td> <td>4.14 ± 0.1 MPa</td> <td>Open</td> </tr> </tbody> </table>	Pressure		Normal		MXZ-3F54VF/VF2/VF3 MXZ-4F83VF MXZ-3F68VF/VF2/VF3 MXZ-5F102VF MXZ-4F72VF/VF2/VF3 MXZ-6F122VF MXZ-4F80VF2/VF3 MXZ-2F53VFHZ MXZ-4F83VFHZ	Normal	HPS	3.14 ± 0.15 MPa	Close		4.14 ± 0.1 MPa	Open										
Pressure		Normal																					
	MXZ-3F54VF/VF2/VF3 MXZ-4F83VF MXZ-3F68VF/VF2/VF3 MXZ-5F102VF MXZ-4F72VF/VF2/VF3 MXZ-6F122VF MXZ-4F80VF2/VF3 MXZ-2F53VFHZ MXZ-4F83VFHZ	Normal																					
HPS	3.14 ± 0.15 MPa	Close																					
	4.14 ± 0.1 MPa	Open																					
Defrost heater MXZ-2F53VFH MXZ-2F53VFH2 MXZ-2F53VFH3 MXZ-2F53VFHZ MXZ-4F83VFHZ	Measure the resistance with a tester. (Part temperature : -10°C - 40°C) <table border="1" data-bbox="571 1252 908 1312"> <thead> <tr> <th>Normal</th> </tr> </thead> <tbody> <tr> <td>349 Ω - 428 Ω</td> </tr> </tbody> </table>	Normal	349 Ω - 428 Ω																				
Normal																							
349 Ω - 428 Ω																							

12-6. TROUBLESHOOTING FLOW

Outdoor unit does not operate.

Ⓐ Check of power supply

MXZ-2F33VF/2F42VF/2F53VF/2F53VFH MXZ-2F33VF2/2F42VF2/2F53VF2/2F53VFH2
MXZ-2F33VF3/2F42VF3/2F53VF3/2F53VFH3

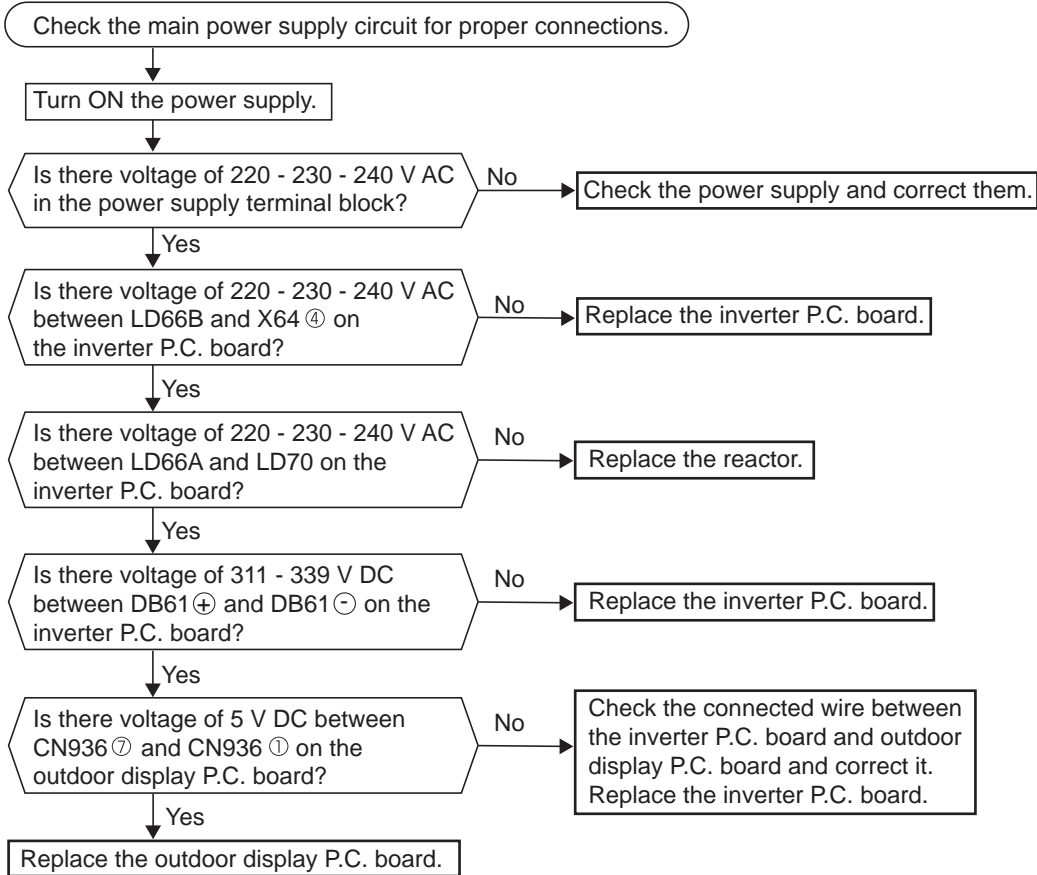

MXZ-3F54VF/3F68VF/4F72VF MXZ-4F83/5F102/6F122VF
MXZ-3F54VF2/3F68VF2/4F72VF2/4F80VF2 MXZ-2F53/4F83VFHZ
MXZ-3F54VF3/3F68VF3/4F72VF3/4F80VF3

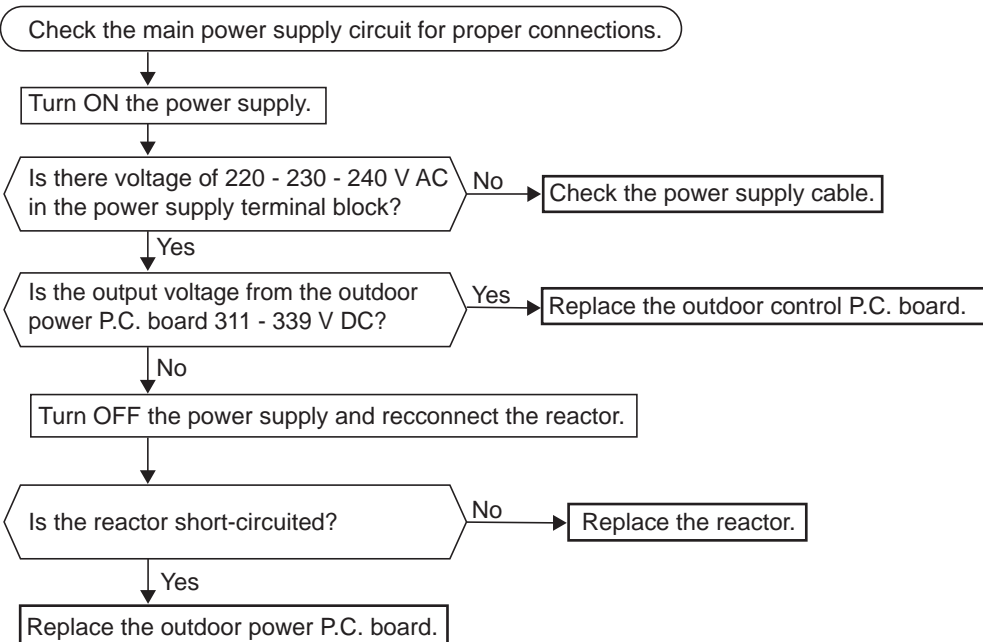

- When the indoor unit does not operate, it cannot be operated either with the remote controller or with the EMERGENCY OPERATION switch.
- When the outdoor unit does not operate, the OPERATION INDICATOR lamp on the indoor unit blinks ON and OFF every 0.5-second.

Ⓑ How to check miswiring and serial signal error (when outdoor unit does not work)

**MXZ-2F33VF/2F42VF/2F53VF/2F53VFH
MXZ-2F33VF2/2F42VF2/2F53VF2/2F53VFH2
MXZ-2F33VF3/2F42VF3/2F53VF3/2F53VFH3**

LED indication for communication status

Communication status is indicated by the LED.

Unit status

Blinking: normal communication
Lighted: abnormal communication or not connected
Not lighted: The outdoor P.C. board is abnormal.
NOTE: "Lighted" and "Not lighted" in the table below does not indicate abnormal.

Outdoor display P.C. board

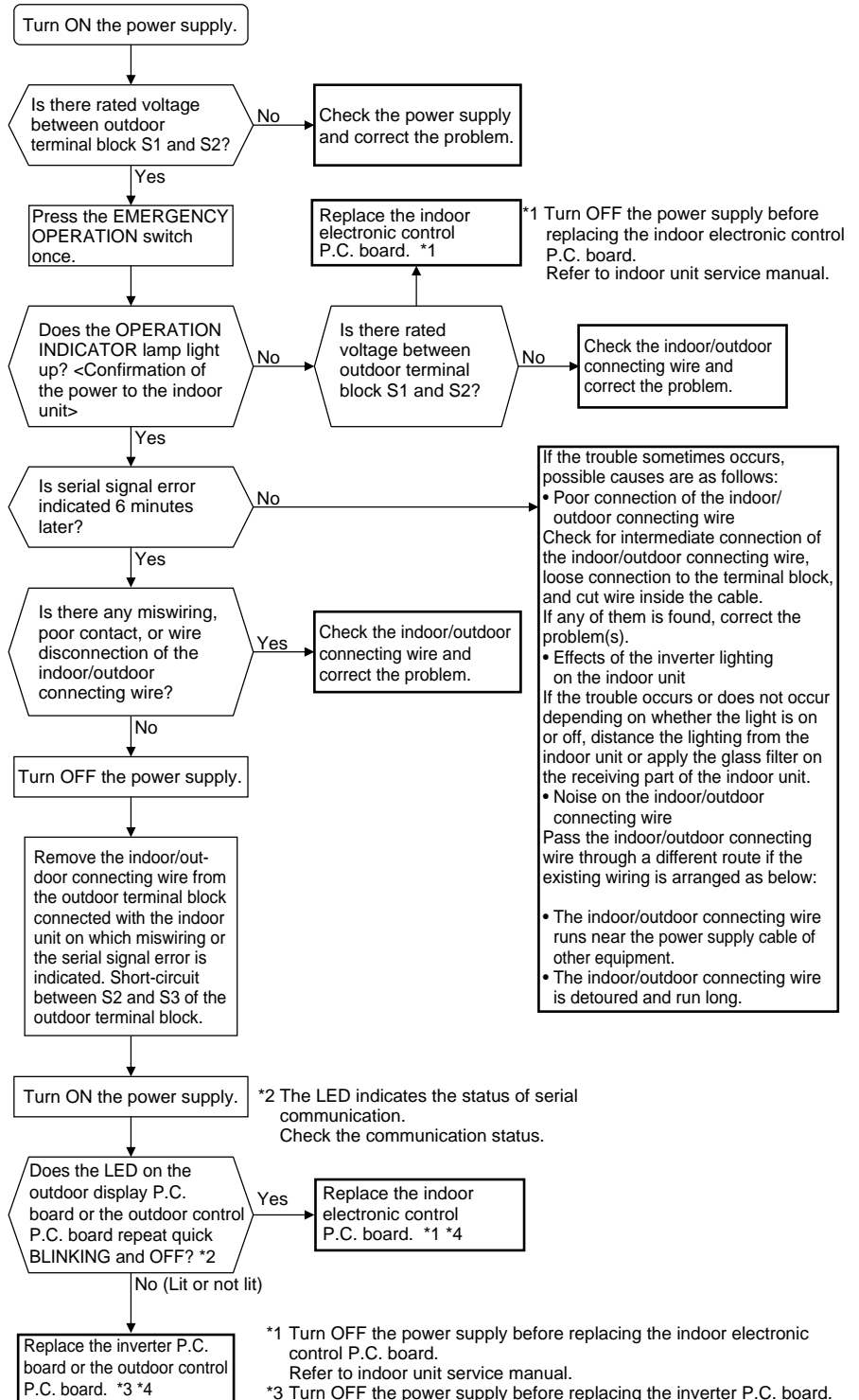
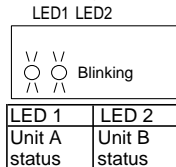

*2 The LED indicates the status of serial communication. Check the communication status.

- *1 Turn OFF the power supply before replacing the indoor electronic control P.C. board. Refer to indoor unit service manual.
- *3 Turn OFF the power supply before replacing the inverter P.C. board. Be careful of residual voltage of smoothing capacitor.
- *4 Remove the short-circuit between outdoor terminal block S2 and S3. Connect the indoor/outdoor connecting wire.

MXZ-3F54VF/3F68VF/4F72VF
MXZ-3F54VF2/3F68VF2/4F72VF2/4F80VF2
MXZ-3F54VF3/3F68VF3/4F72VF3/4F80VF3

MXZ-4F83/5F102/6F122VF
MXZ-2F53/4F83VFHZ

LED indication for communication status

Communication status is indicated by the LED.

Unit status
 Blinking: normal communication
 Lighting: abnormal communication or not connected

Pattern 1 and 2 is repeatedly displayed alternately. Each pattern is displayed for 10 seconds.

NOTE: "Lighting" in the table below does not indicate abnormal communication.

Outdoor control P.C. board

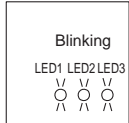

Pattern	LED 1	LED 2	LED 3
1	Unit A status	Unit B status	Lit
2	Unit C status	Unit D status	Not lit

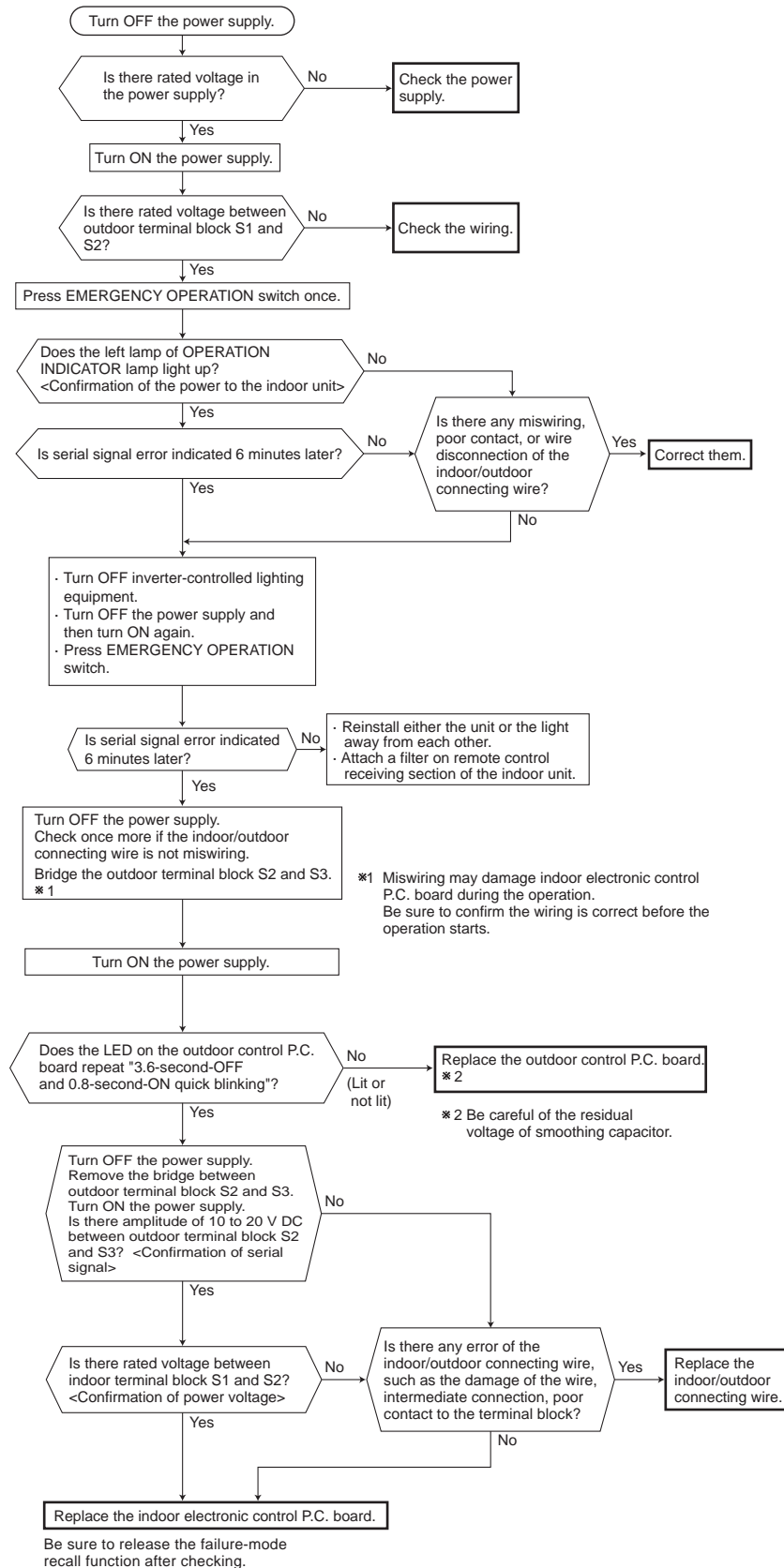

The cooling operation or heating operation does not operate.

© Check of R.V. coil

MXZ-2F33VF/2F42VF/2F53VF/2F53VFH
MXZ-2F33VF2/2F42VF2/2F53VF2/2F53VFH2
MXZ-2F33VF3/2F42VF3/2F53VF3/2F53VFH3

Connector	MXZ-2F
CN721	Inverter P.C. board

• The heating operation does not operate.

1. Disconnect the lead wire leading to the compressor.
2. 3 minutes after turning ON the power supply, start EMERGENCY OPERATION in HEAT mode.

Is there voltage of 220 - 230 - 240 V AC between pin1 and pin2 at connector CN721?

No

Replace the inverter P.C. board.

Yes

Turn OFF the power supply. Disconnect the connector CN721.

Is there normal resistance to R.V. coil?
(Refer to 12-5.)

No

Replace the R.V. coil.

Yes

Replace the 4-way valve.

• The cooling operation does not operate.

1. Disconnect the lead wire leading to the compressor.
2. 3 minutes after turning ON the power supply, start EMERGENCY OPERATION in COOL mode.

Is there voltage of 220 - 230 - 240 V AC between pin1 and pin2 at connector CN721?

Yes

Replace the inverter P.C. board.

No

Replace the 4-way valve.

MXZ-3F54VF/3F68VF/4F72VF
MXZ-3F54VF2/3F68VF2/4F72VF2/4F80VF2
MXZ-3F54VF3/3F68VF3/4F72VF3/4F80VF3

MXZ-4F83/5F102/6F122VF
MXZ-2F53/4F83VFHZ

Connector	MXZ-3F, 4F, 5F, 6F 2F53/4F83VFHZ
CNAC CN712	Outdoor control P.C. board
CNAC2	Outdoor power P.C. board

• When cooling operation does not work.

1. Disconnect the lead wire leading to the compressor.
2. 3 minutes after turning ON the power supply, start EMERGENCY OPERATION in COOL mode.

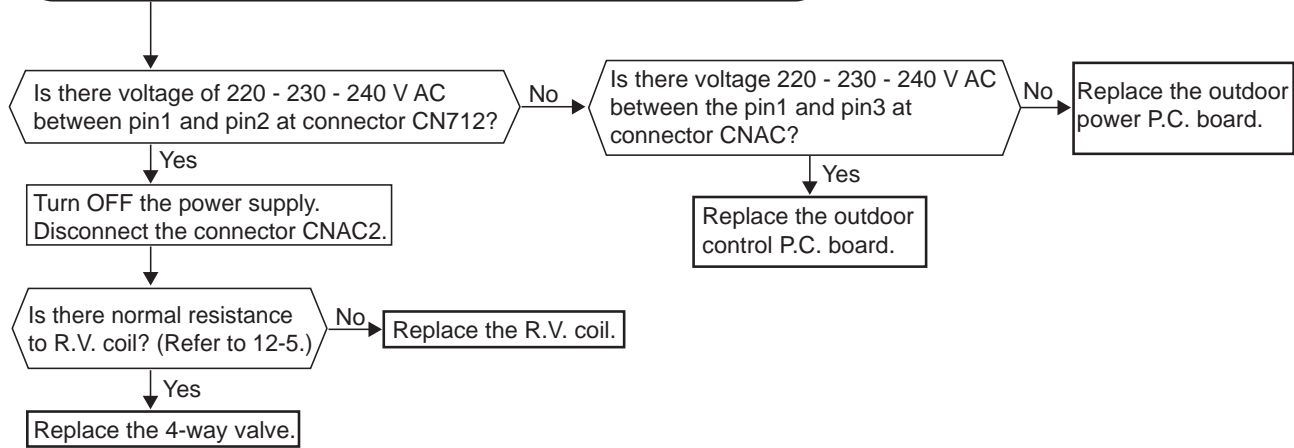

• When heating operation does not work.

1. Disconnect the lead wire leading to the compressor.
2. 3 minutes after turning ON the power supply, start EMERGENCY OPERATION in HEAT mode.

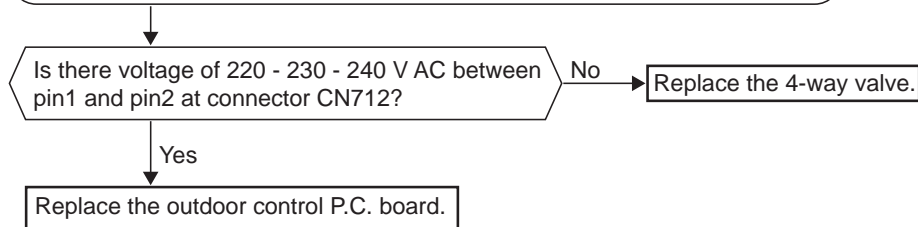

- When cooling, heat exchanger of non-operating indoor unit frosts.
- When heating, non-operating indoor unit gets warm.

① Check of LEV

Connector	MXZ-2F	MXZ-3F, 4F, 5F,6F 2F53/4F83VFHZ
CN724 CN725	Inverter P.C. board	—
CN791 CN792 CN793 CN794 CN795 CN796 CN797	—	Outdoor control P.C. board

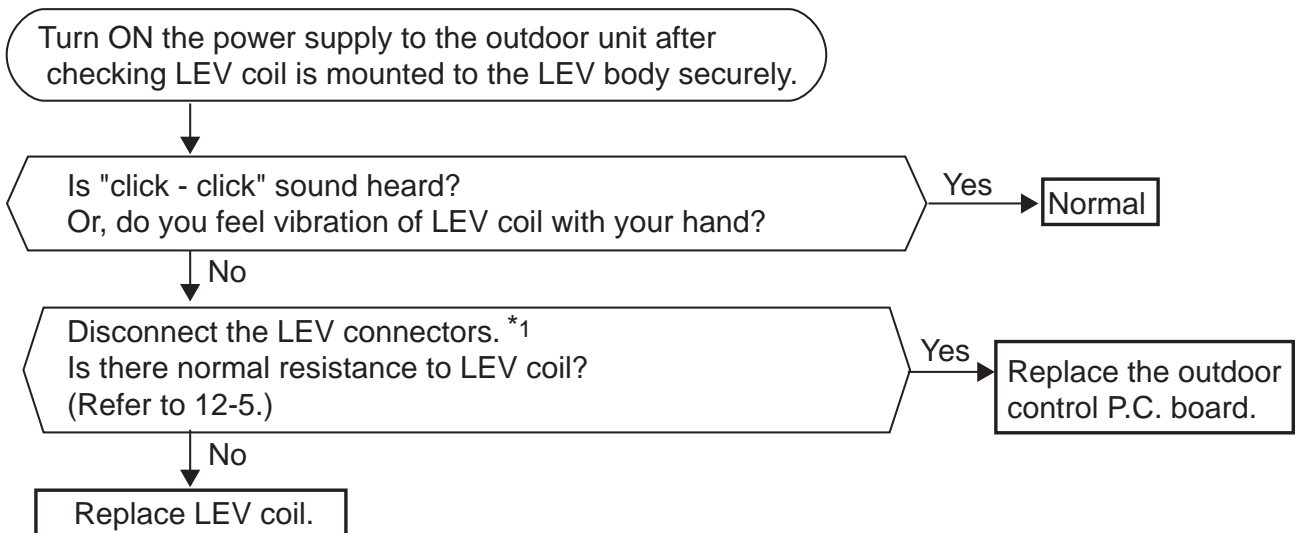

*1

LEV Connector	LEV	MXZ-2F	MXZ-3F	MXZ-4F72 MXZ-4F80VF	MXZ-4F83VF	MXZ-5F	MXZ-6F	MXZ-2F53VFHZ	MXZ-4F83VFHZ
CN724	LEV A	●	—	—	—	—	—	—	—
CN725	LEV B	●	—	—	—	—	—	—	—
CN791	LEV A	—	●	●	●	●	●	●	●
CN792	LEV B	—	●	●	●	●	●	●	●
CN793	LEV C	—	●	●	●	●	●	—	●
CN794	LEV D	—	—	●	●	●	●	—	●
CN795	LEV E	—	—	—	—	●	●	—	—
CN796	LEV F	—	—	—	—	—	●	—	—
CN797	LEV R	—	●	●	—	—	—	—	—

- When heating, room does not get warm.
- When cooling, room does not get cool.

⑤ How to check inverter/compressor

Disconnect the terminal of the compressor or the connector (CNMC) between the compressor and the outdoor power P.C. board. 3 minutes after the power supply is turned ON, start EMERGENCY OPERATION.

Measure the voltage between each lead wire leading to the compressor.
 U (BLK) - V (WHT)
 V (WHT) - W (RED)
 W (RED) - U (BLK)
 Output voltage: 50V-250V
 Is proper output voltage detected?
 ※1, ※2

- ※1 • After the outdoor fan starts running, wait for 1 minute or more before measuring the voltage.
- The output voltage values have the tolerance of $\pm 20\%$.
- ※2 • The output differs depending on the capacity or the number of indoor units to be operated.

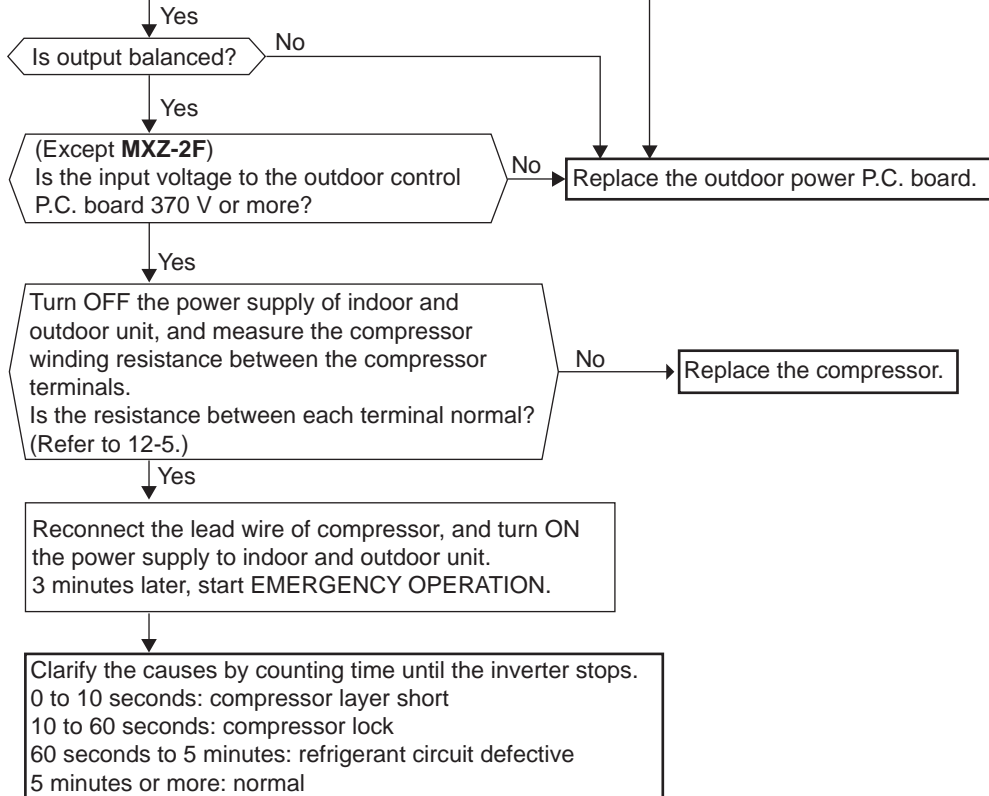

• When thermistor is abnormal.

Ⓔ Check of outdoor thermistors

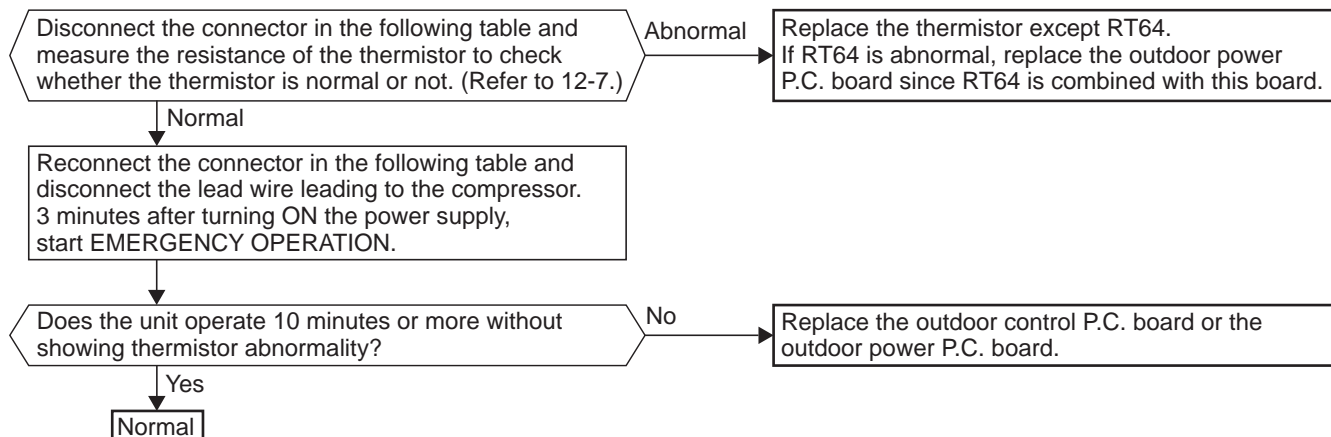

- MXZ-2F33VF/2F42VF/2F53VF
- MXZ-2F33VF2/2F42VF2/2F53VF2
- MXZ-2F33VF3/2F42VF3/2F53VF3
- MXZ-2F53VFH
- MXZ-2F53VFH2
- MXZ-2F53VFH3

Thermistor	Symbol	Connector, Pin No.	Board
Defrost	RT61	CN641 pin1 and pin2	Inverter P.C. board
Discharge temperature	RT62	CN641 pin3 and pin4	
Fin temperature	RT64	CN642 pin1 and pin2	
Ambient temperature	RT65	CN643 pin1 and pin2	
Outdoor heat exchanger temperature	RT68	CN644 pin1 and pin3	

- MXZ-3F54VF/3F68VF/4F72VF
- MXZ-3F54VF2/3F68VF2/4F72VF2/4F80VF2
- MXZ-3F54VF3/3F68VF3/4F72VF3/4F80VF3
- MXZ-4F83/5F102/6F112VF
- MXZ-2F53/4F83VFHZ

Thermistor	Symbol	Connector, Pin No.	Board
Defrost	RT61	Between CNTH1 pin1 and pin2	Outdoor control P.C. board
Discharge temperature	RT62	Between CNTH1 pin3 and pin4	
Outdoor heat exchanger temperature	RT68	Between CNTH1 pin7 and pin8	
Ambient temperature	RT65	Between CNTH2 pin1 and pin2	Outdoor power P.C. board
Fin temperature	RT64	Between CN171 pin1 and pin2	

• Fan motor does not operate or stops operating shortly after starting the operation.

Ⓒ Check of outdoor fan motor

MXZ-2F33VF/2F42VF/2F53VF/2F53VFH
 MXZ-2F33VF2/2F42VF2/2F53VF2/2F53VFH2
 MXZ-2F33VF3/2F42VF3/2F53VF3/2F53VFH3

Connector	MXZ-2F
CN931 CN932	Inverter P.C. board

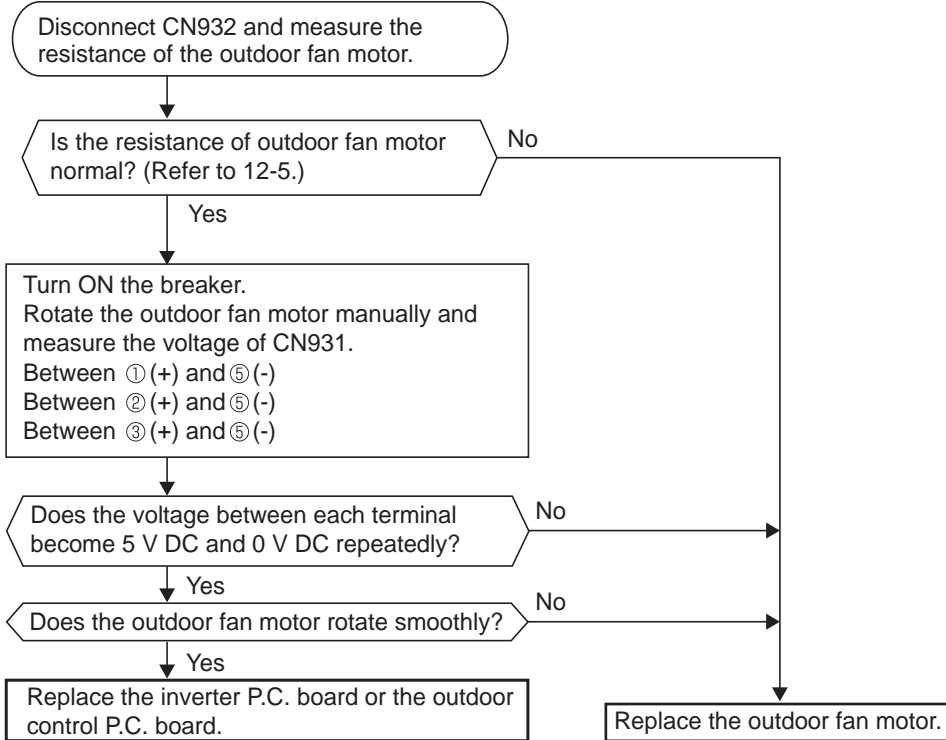

MXZ-3F54VF/3F68VF/4F72VF
MXZ-3F54VF2/3F68VF2/4F72VF2/4F80VF2
MXZ-3F54VF3/3F68VF3/4F72VF3/4F80VF3

MXZ-4F83/5F102/6F122VF
MXZ-2F53/4F83VFHZ

Connector	MXZ-3F, 4F, 5F, 6F 2F53/4F83VFHZ
CNF1	Outdoor control P.C. board

Measuring points	Resistance
pin1 - pin4	∞
pin5 - pin4	60 kΩ
pin6 - pin4	160 kΩ
pin7 - pin4	∞

* To measure the resistance, connect the negative (-) end of the tester to pin4.

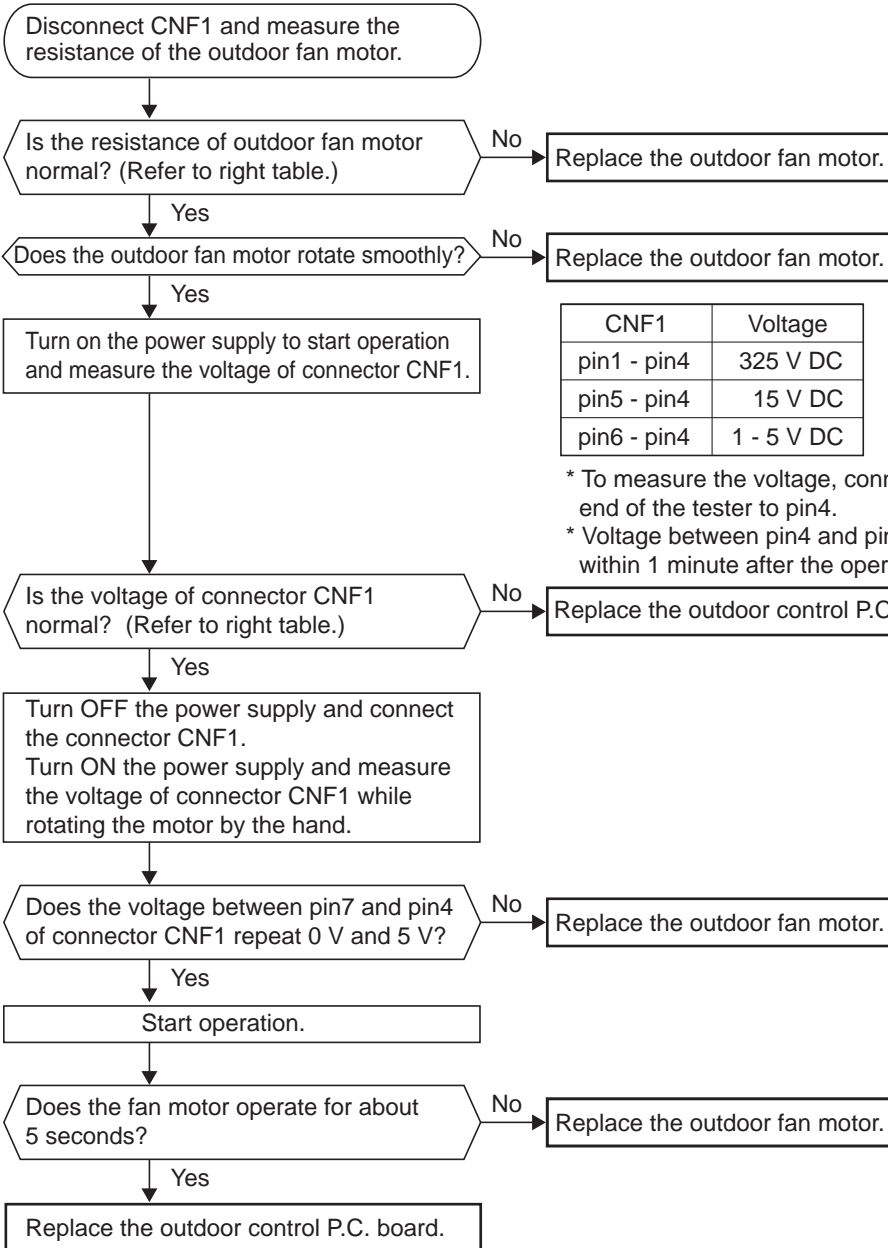

CNF1	Voltage
pin1 - pin4	325 V DC
pin5 - pin4	15 V DC
pin6 - pin4	1 - 5 V DC

* To measure the voltage, connect the negative (-) end of the tester to pin4.

* Voltage between pin4 and pin6 should be measured within 1 minute after the operation starts.

• When the operation frequency does not go up from the lowest frequency.

Ⓜ Check of HPS

MXZ-3F54VF/3F68VF/4F72VF **MXZ-4F83/5F102VF**
MXZ-3F54VF2/3F68VF2/4F72VF2/4F80VF2 **MXZ-2F53/4F83VFHZ**
MXZ-3F54VF3/3F68VF3/4F72VF3/4F80VF3

Connector	MXZ-3F, 4F, 5F, 6F 2F53/4F83VFHZ
CN63H	Outdoor control P.C. board

1. Disconnect the connector CN63H in the outdoor control P.C. board.
2. Check the resistance of HPS after 1 minute has passed since the outdoor unit power supply was turned OFF.

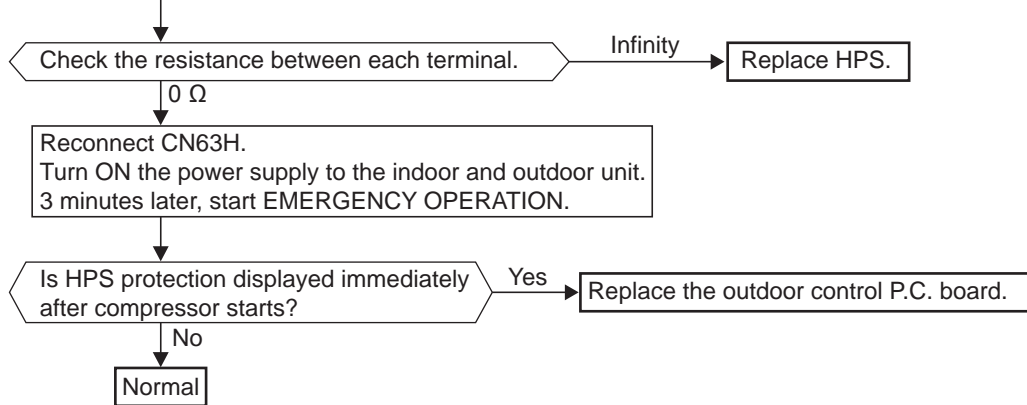

① The other cases

Indoor unit does not operate. (different operating models in multi system)

- When you try to run 2 indoor units simultaneously, one for cooling and the other for heating, the unit which transmits signal to the outdoor unit first decides the operation mode.
- When the above situation occurs, set all the indoor units to the same mode, turn OFF the indoor units, and then turn them back ON.
- Though the top of the indoor unit sometimes gets warm, this does not mean malfunction. The reason is that the refrigerant gas continuously flows into the indoor unit even while it is not operating.

Ⓜ Check of bus-bar voltage

MXZ-3F54VF/3F68VF/4F72VF **MXZ-4F83/5F102/6F122VF**
MXZ-3F54VF2/3F68VF2/4F72VF2/4F80VF2 **MXZ-2F53/4F83VFHZ**
MXZ-3F54VF3/3F68VF3/4F72VF3/4F80VF3

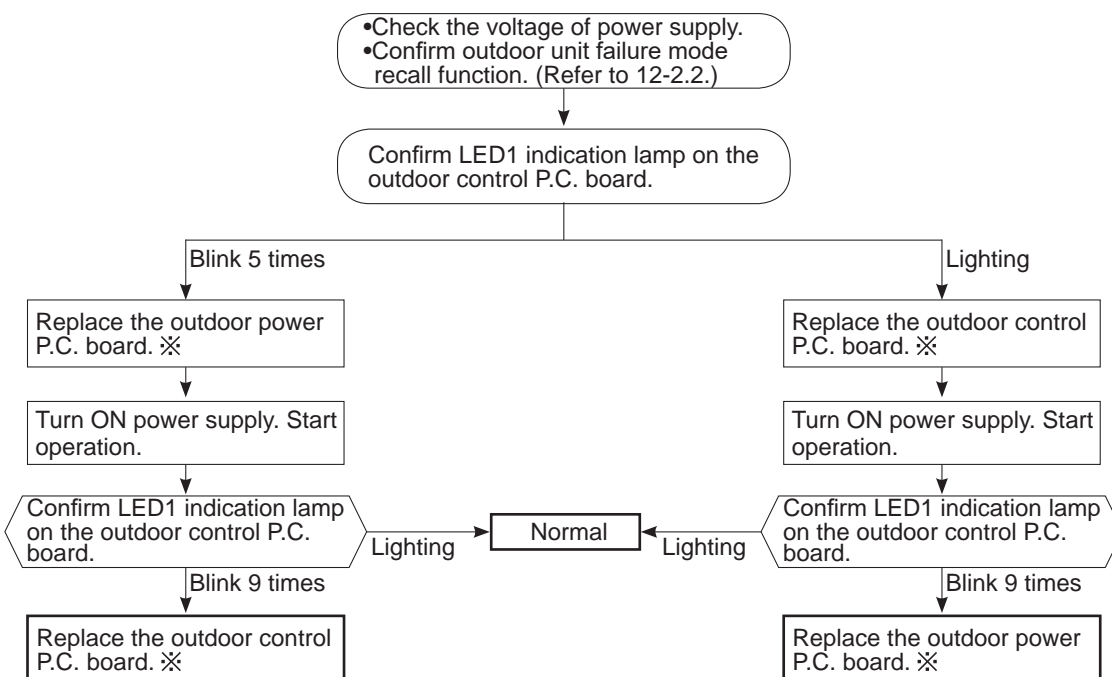

✖ Turn OFF power supply before removing P.C. board.

⌚ **Check of outdoor refrigerant circuit**

MXZ-2F33VF/2F42VF/2F53VF/2F53VFH
MXZ-2F33VF2/2F42VF2/2F53VF2/2F53VFH2
MXZ-2F33VF3/2F42VF3/2F53VF3/2F53VFH3
MXZ-6F122VF

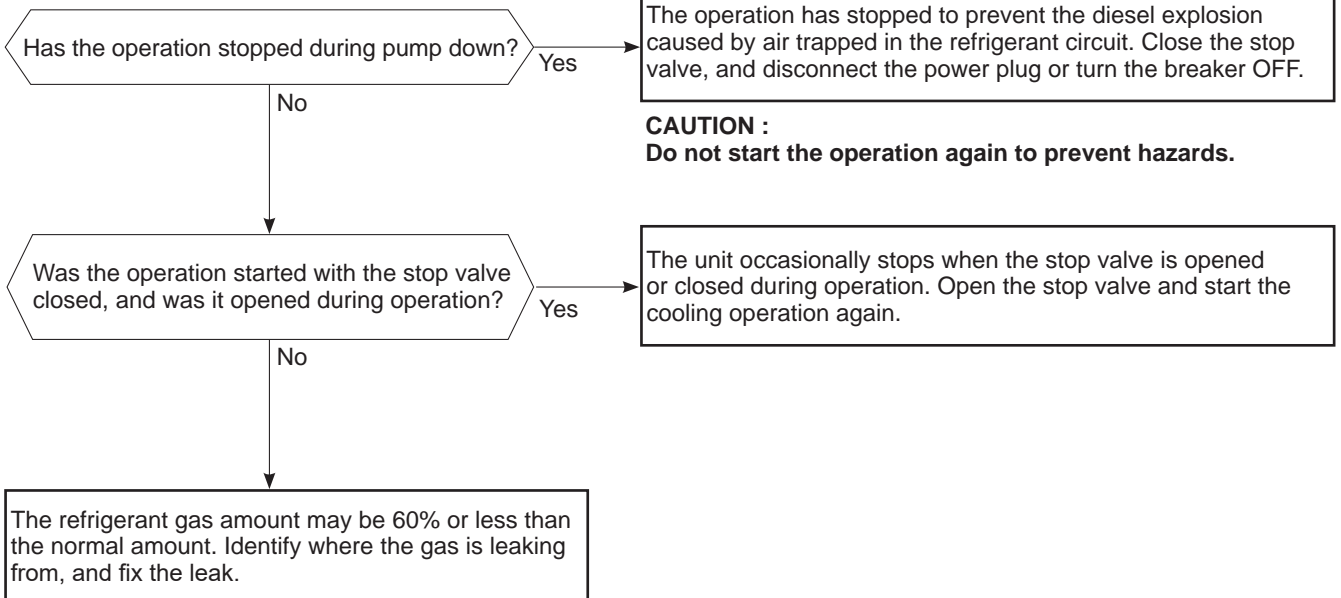

12-7. TEST POINT DIAGRAM AND VOLTAGE

1. Inverter P.C. board

MXZ-2F33VF MXZ-2F42VF MXZ-2F53VF MXZ-2F53VFH
 MXZ-2F33VF2 MXZ-2F42VF2 MXZ-2F53VF2 MXZ-2F53VFH2
 MXZ-2F33VF3 MXZ-2F42VF3 MXZ-2F53VF3 MXZ-2F53VFH3

Back side of unit

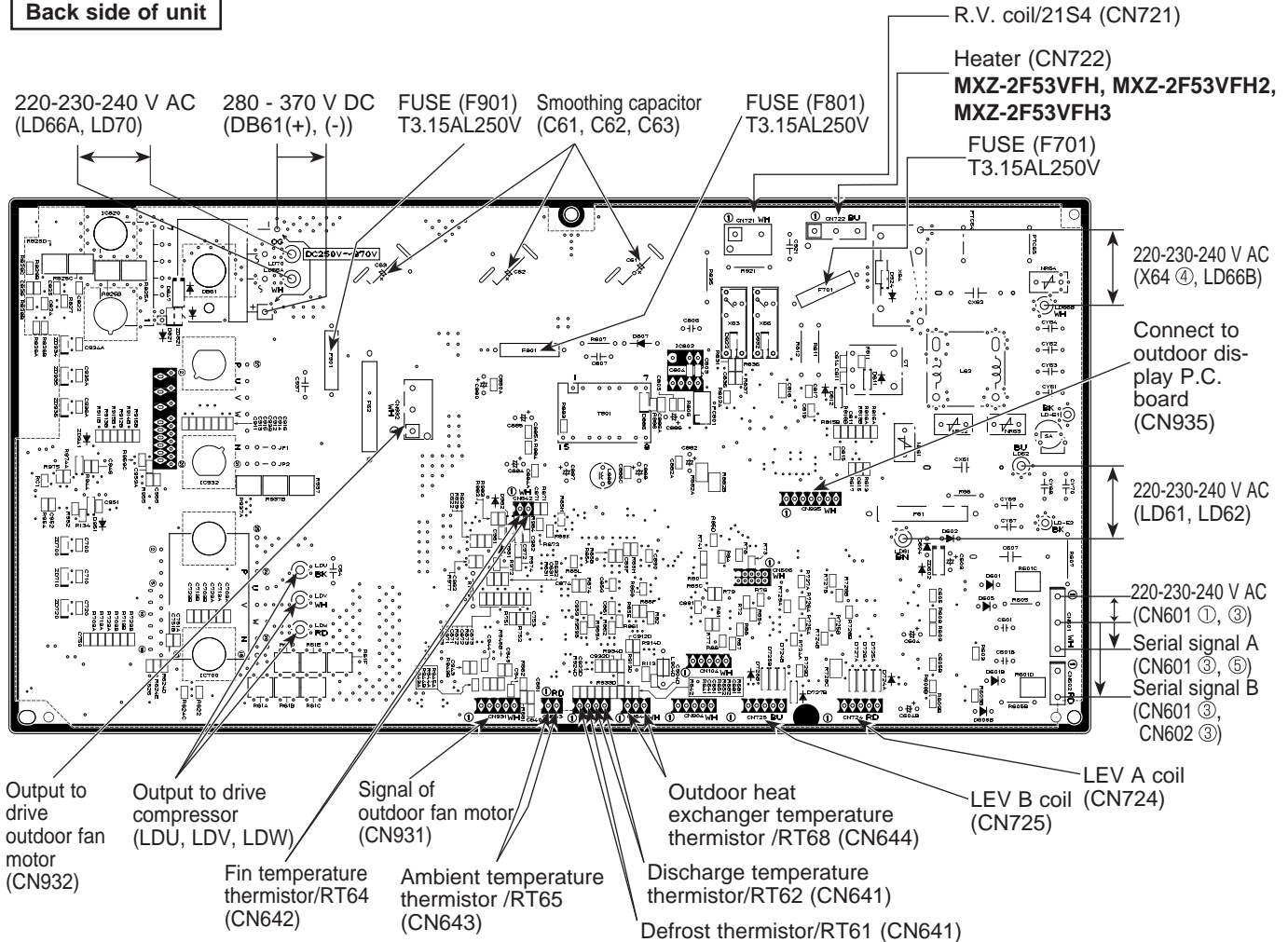

Front side of unit

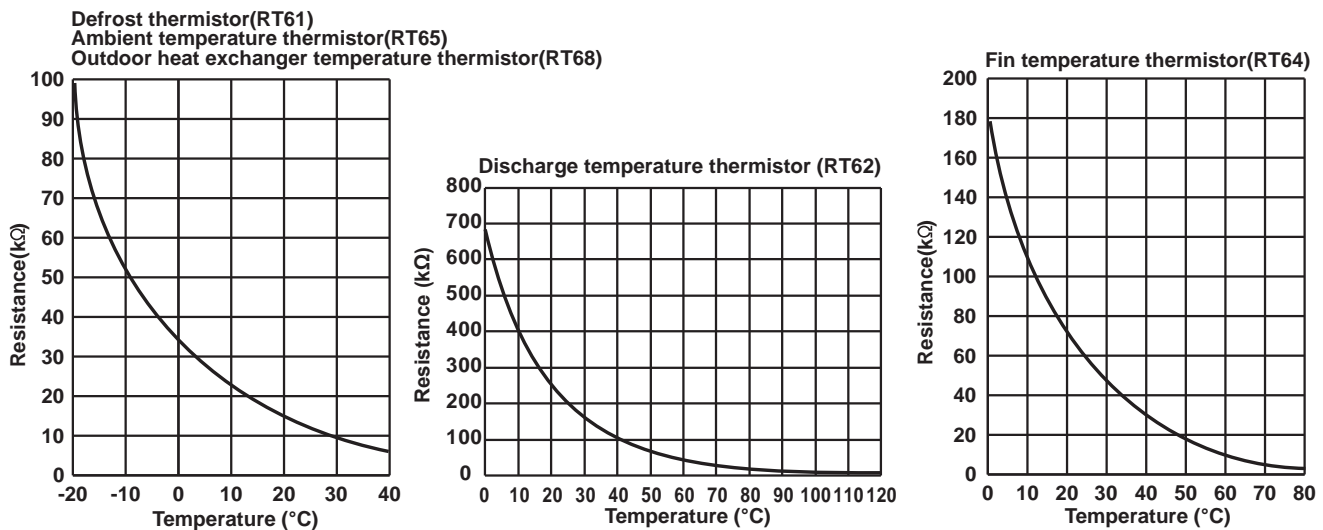

2. Outdoor control P.C. board

MXZ-3F54VF MXZ-3F68VF MXZ-4F72VF
MXZ-3F54VF2 MXZ-3F68VF2 MXZ-4F72VF2 MXZ-4F80VF2
MXZ-3F54VF3 MXZ-3F68VF3 MXZ-4F72VF3 MXZ-4F80VF3

Defrost thermistor (RT61)
 Ambient temperature thermistor (RT65)
 Outdoor heat exchanger temperature thermistor (RT68)

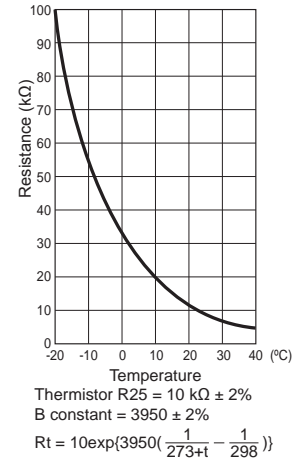
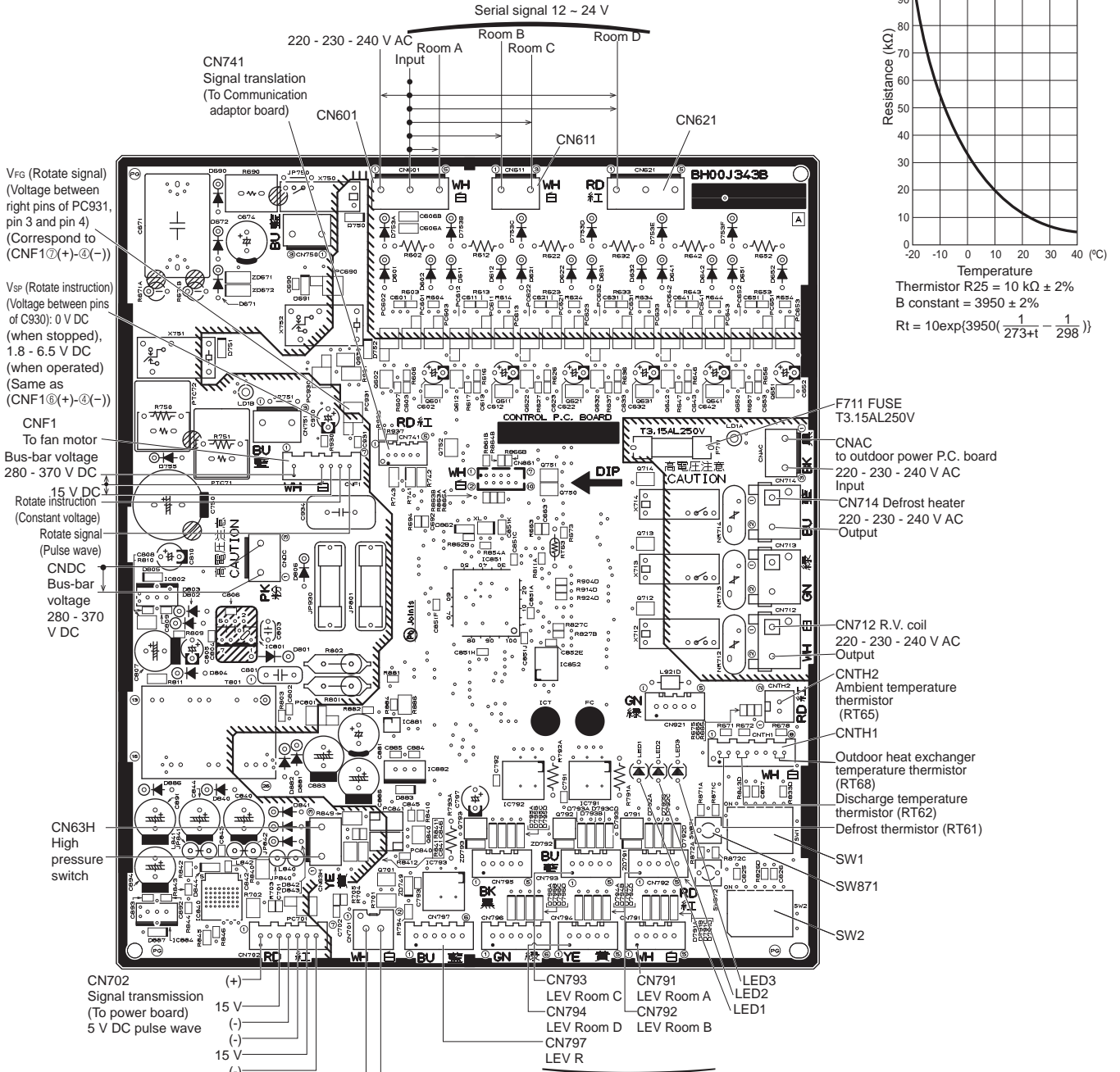

- F711 FUSE T3.15A/250V
- CNAC to outdoor power P.C. board
- Input 220 - 230 - 240 V AC
- CN714 Defrost heater 220 - 230 - 240 V AC Output
- CN712 R.V. coil 220 - 230 - 240 V AC Output
- CNTH2 Ambient temperature thermistor (RT65)
- CNTH1 Outdoor heat exchanger temperature thermistor (RT68)
- Discharge temperature thermistor (RT62)
- Defrost thermistor (RT61)
- SW1
- SW871
- SW2

- V_R (Rotate signal) (Voltage between right pins of PC931, pin 3 and pin 4) (Correspond to (CNF1①(+)-②(-)))
- V_{SP} (Rotate instruction) (Voltage between pins of C930): 0 V DC (when stopped), 1.8 - 6.5 V DC (when operated) (Same as (CNF1①(+)-②(-)))
- CNF1 To fan motor Bus-bar voltage 280 - 370 V DC
- 15 V DC Rotate instruction (Constant voltage)
- Rotate signal (Pulse wave)
- CNDC Bus-bar voltage 280 - 370 V DC

- CN63H High pressure switch
- CN702 Signal transmission (To power board) 15 V (+) 5 V DC pulse wave (-) 15 V (-) 5 V DC pulse wave (+)
- CN701 Signal transmission (To power board) (-) 15 V (+) 5 V DC pulse wave (-)

- CN793 LEV Room C
- CN794 LEV Room D
- CN797 LEV R
- CN791 LEV Room A
- CN792 LEV Room B
- LEV: 12 V DC pulse wave
- LED3 LED2 LED1

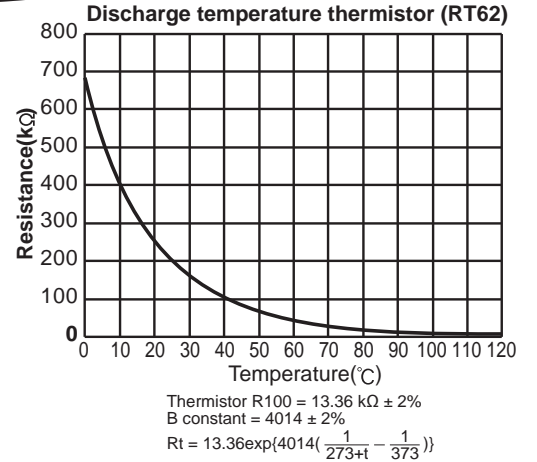

MXZ-4F83VF
MXZ-5F102VF
MXZ-2F53VFHZ

Defrost thermistor (RT61)
Ambient temperature thermistor (RT65)
Outdoor heat exchanger temperature thermistor (RT68)

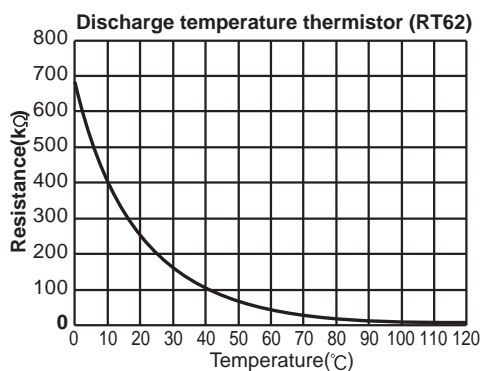
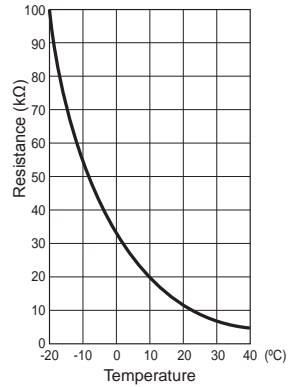
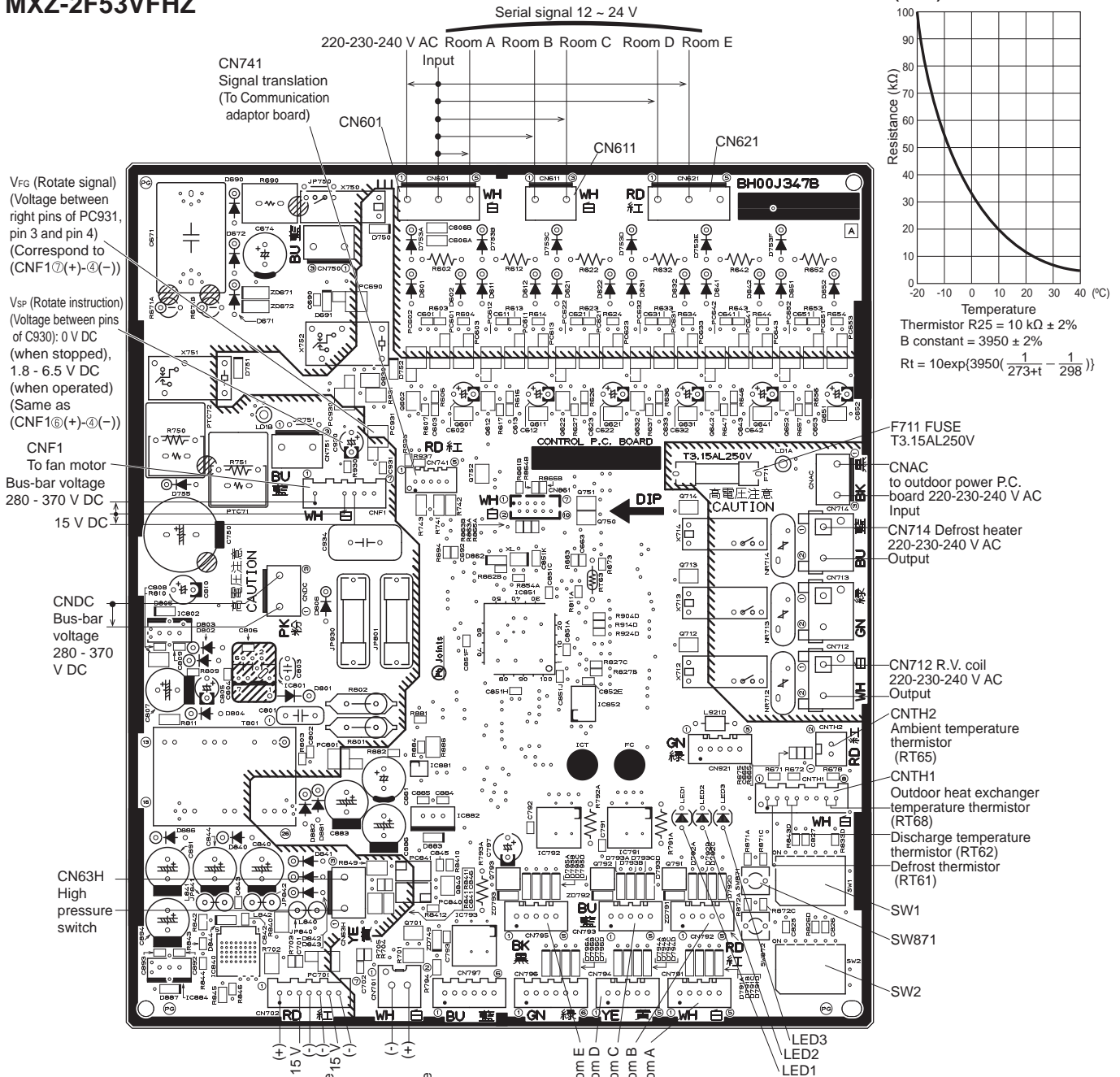

MXZ-6F122VF
MXZ-4F83VFHZ

Defrost thermistor (RT61)
Ambient temperature thermistor (RT65)
Outdoor heat exchanger temperature thermistor (RT68)

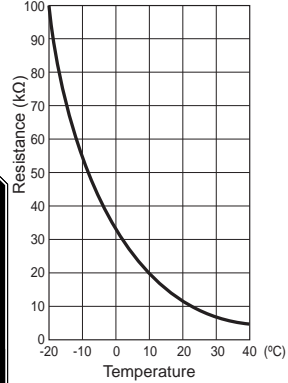
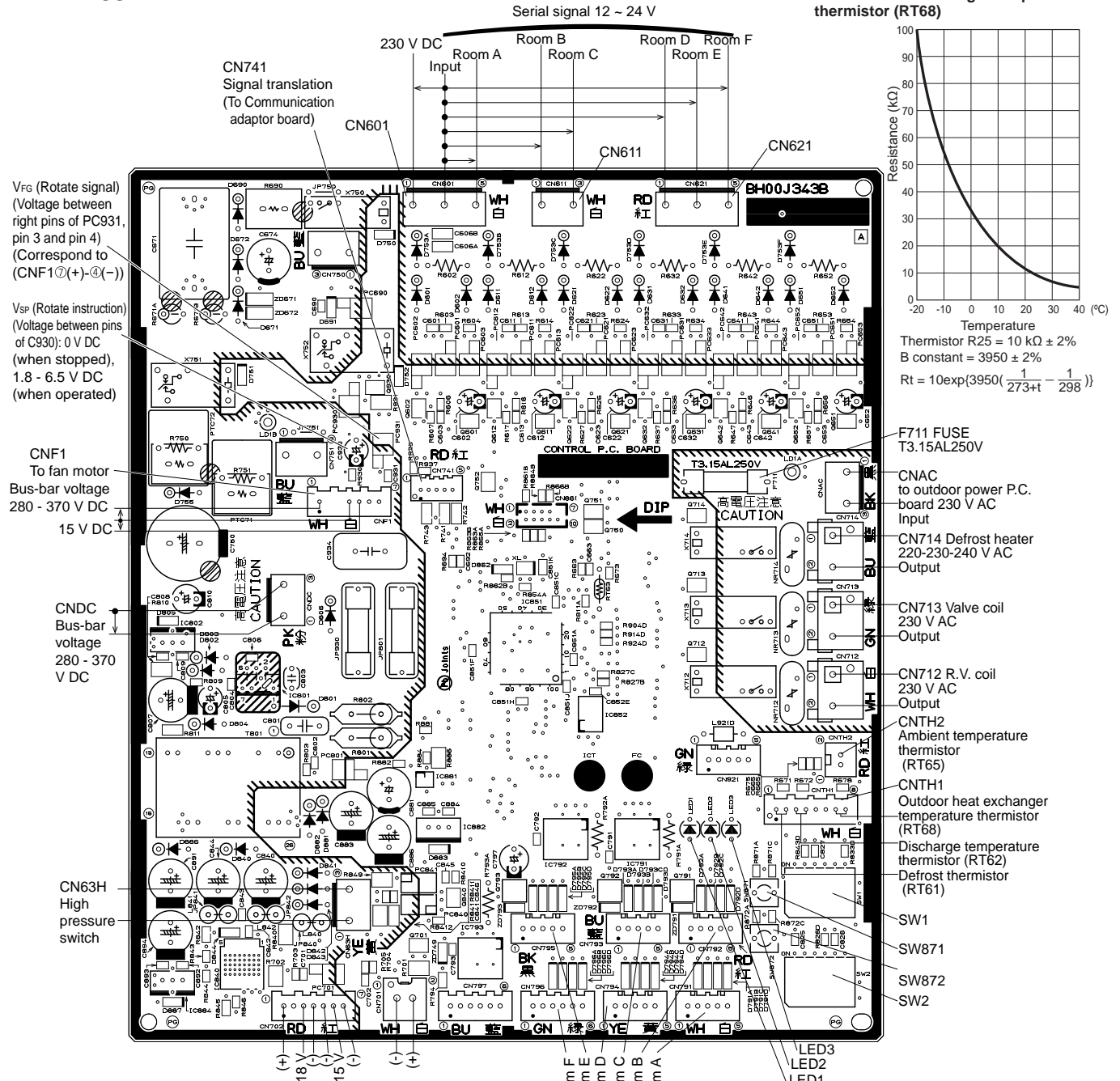

- F711 FUSE T3.15A/250V
- CNAC to outdoor power P.C. board 230 V AC Input
- CN714 Defrost heater 220-230-240 V AC Output
- CN713 Valve coil 230 V AC Output
- CN712 R.V. coil 230 V AC Output
- CNTH2 Ambient temperature thermistor (RT65)
- CNTH1 Outdoor heat exchanger temperature thermistor (RT68)
- Discharge temperature thermistor (RT62)
- Defrost thermistor (RT61)
- SW1
- SW871
- SW872
- SW2

V_{FG} (Rotate signal)
(Voltage between right pins of PC931, pin 3 and pin 4)
(Correspond to (CNF1②(+)-④(-)))

V_{SP} (Rotate instruction)
(Voltage between pins of C930): 0 V DC (when stopped), 1.8 - 6.5 V DC (when operated)

CNF1 To fan motor Bus-bar voltage 280 - 370 V DC

15 V DC

CNDC Bus-bar voltage 280 - 370 V DC

CN63H High pressure switch

CN702 Signal transmission (To power board) 5 V DC pulse wave

CN701 Signal transmission (To power board) 5 V DC pulse wave

CN796 LEV Room F
CN795 LEV Room E
CN794 LEV Room D
CN793 LEV Room C
CN792 LEV Room B
CN791 LEV Room A

LEV: 12 V DC pulse wave

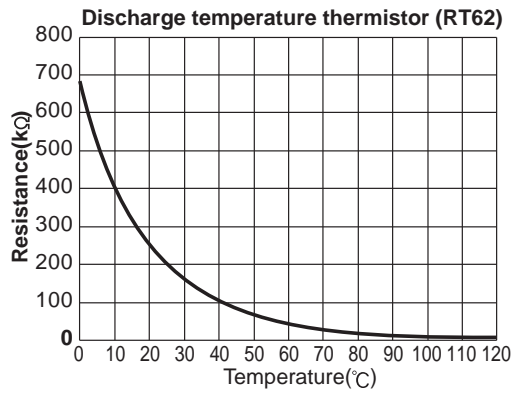

3. Outdoor power P.C. board

MXZ-3F54VF MXZ-3F68VF MXZ-4F72VF
MXZ-3F54VF2 MXZ-3F68VF2 MXZ-4F72VF2 MXZ-4F80VF2
MXZ-3F54VF3 MXZ-3F68VF3 MXZ-4F72VF3 MXZ-4F80VF3

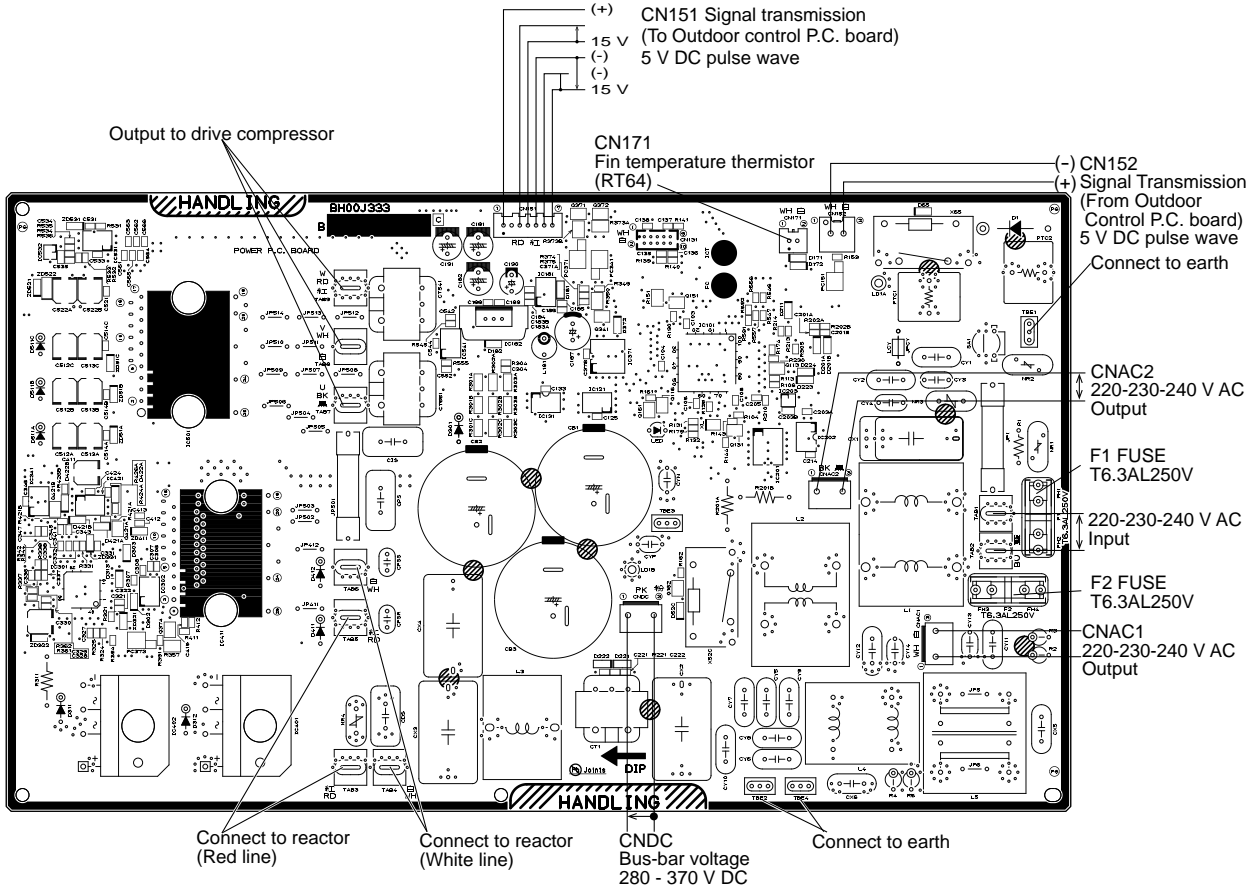

MXZ-4F83VF
MXZ-5F102VF
MXZ-2F53VFHZ

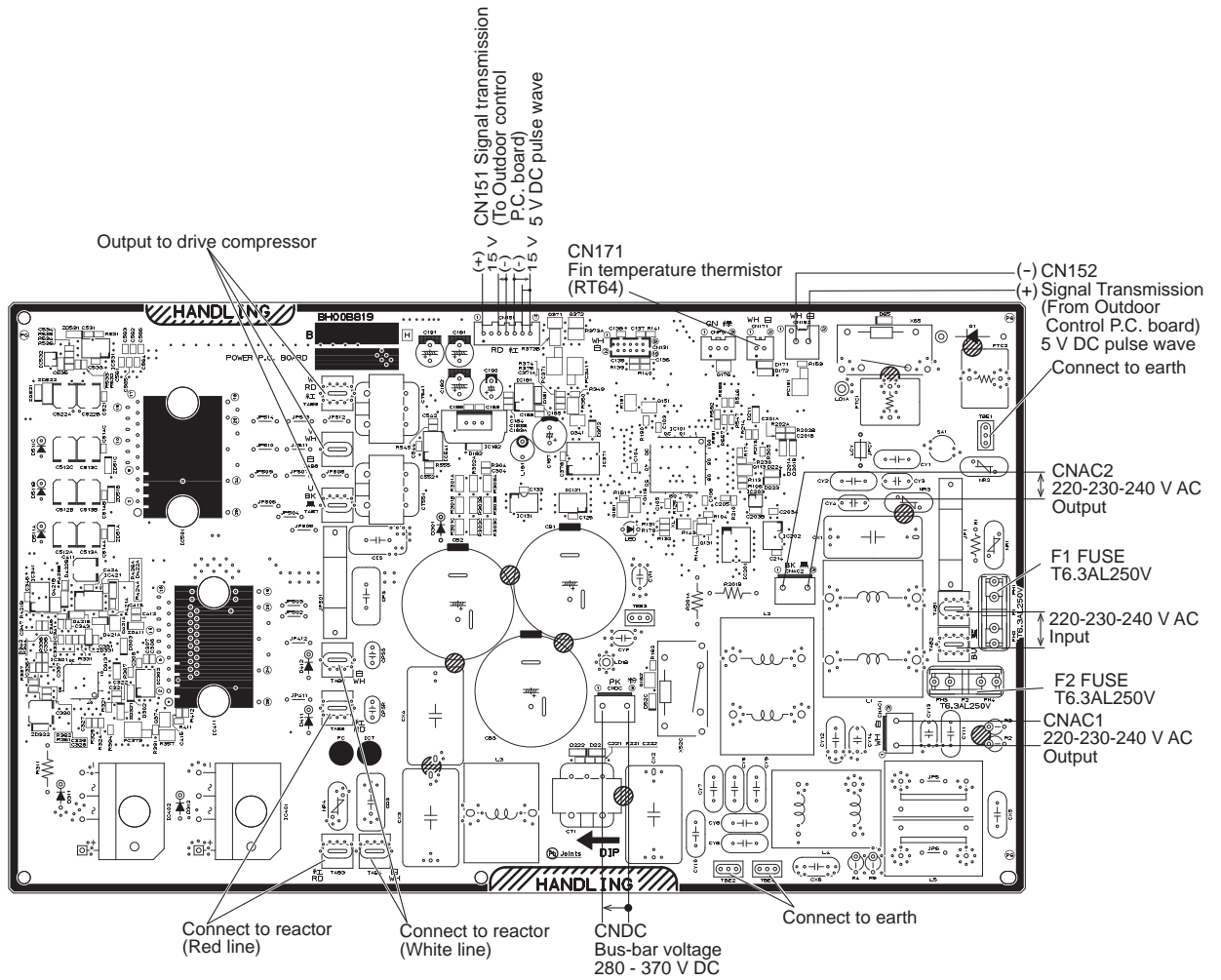

Fin temperature thermistor (RT64)

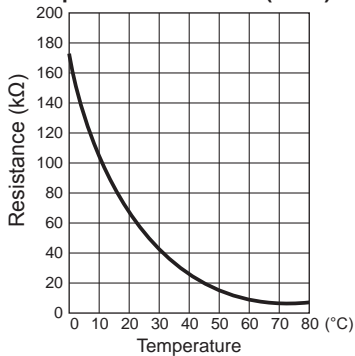

Thermistor R50 = 17 kΩ ± 2%
 B constant = 4150 ± 3%

$$R_t = 17 \exp\left\{4150 \left(\frac{1}{273+t} - \frac{1}{323} \right)\right\}$$

MXZ-6F122VF
MXZ-4F83VFHZ

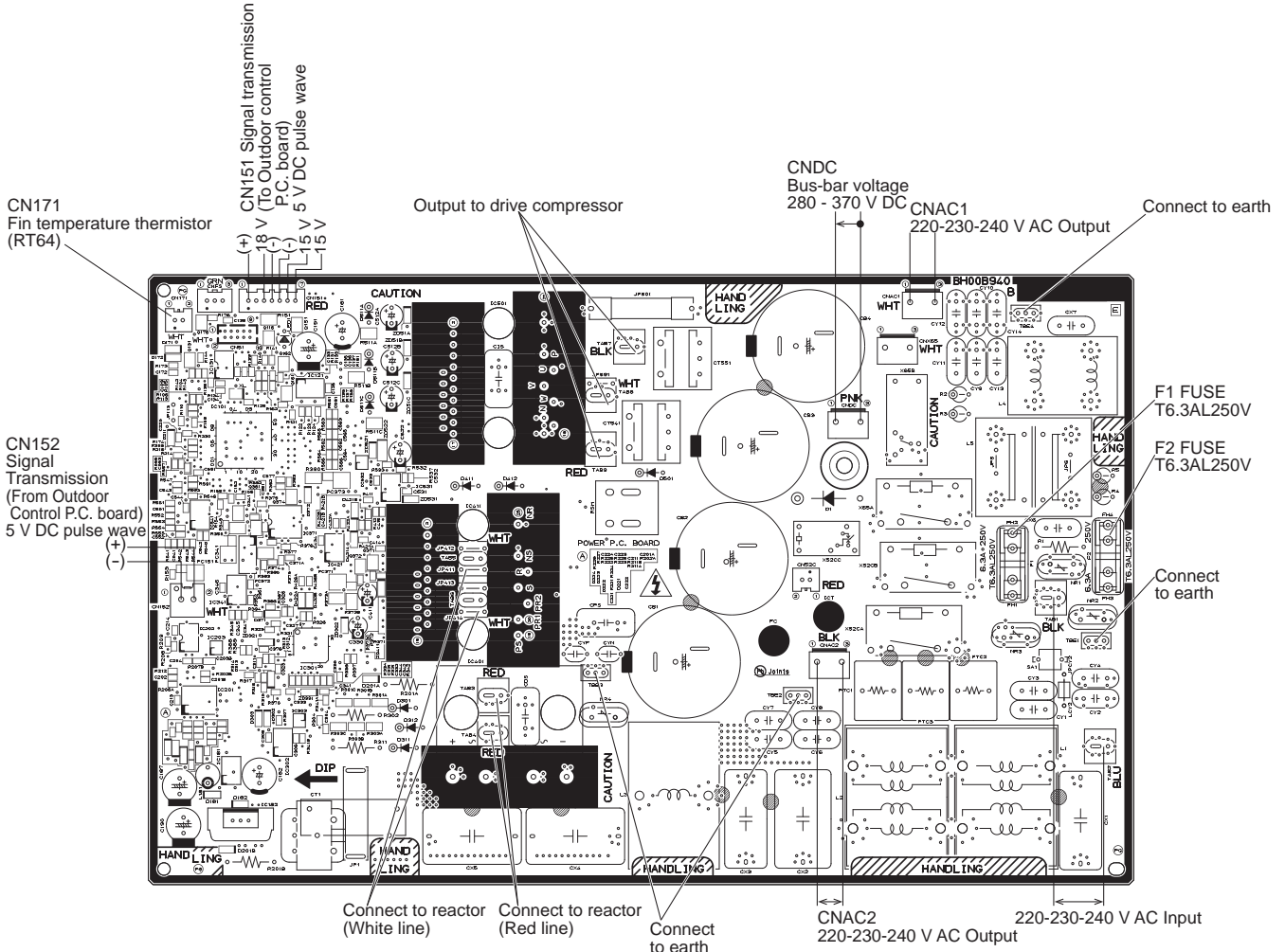

Fin temperature thermistor (RT64)

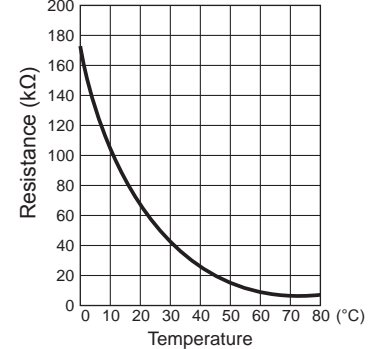

Thermistor R50 = 17 kΩ ± 2%
B constant = 4150 ± 3%
 $R_t = 17 \exp\left\{4150 \left(\frac{1}{273+t} - \frac{1}{323}\right)\right\}$

4. Outdoor display P.C. board

MXZ-2F33VF MXZ-2F42VF MXZ-2F53VF MXZ-2F53VFH
 MXZ-2F33VF2 MXZ-2F42VF2 MXZ-2F53VF2 MXZ-2F53VFH2
 MXZ-2F33VF3 MXZ-2F42VF3 MXZ-2F53VF3 MXZ-2F53VFH3

To inverter P.C. board (CN936)

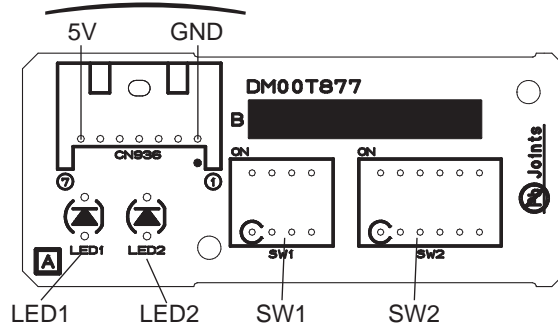

Fin temperature thermistor (RT64)

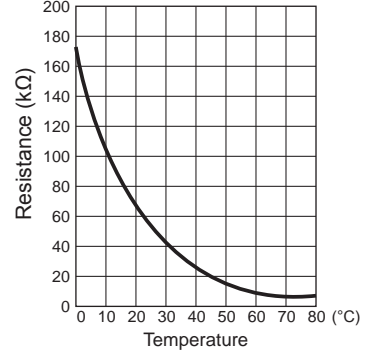

Thermistor R50 = 17 kΩ ± 2%
 B constant = 4150 ± 3%

$$R_t = 17 \exp\left\{4150 \left(\frac{1}{273+t} - \frac{1}{323} \right)\right\}$$

<Detaching method of the terminal with locking mechanism>

The terminal which has the locking mechanism can be detached as shown below. There are following 2 types of the terminal with locking mechanism. The terminal without locking mechanism can be detached by pulling it out. Check the shape of the terminal before detaching.

(1) Slide the sleeve and check if there is a locking lever or not.

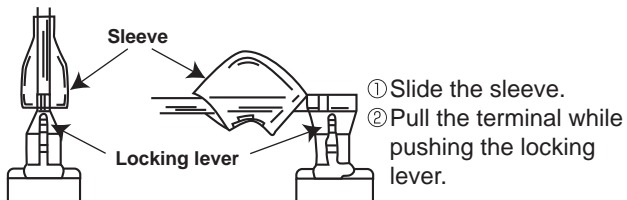

(2) The terminal with the connector shown below has the locking mechanism.

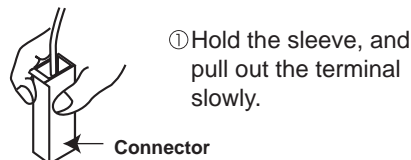

- 13-1. MXZ-2F33VF MXZ-2F42VF MXZ-2F53VF MXZ-2F53VFH**
MXZ-2F33VF2 MXZ-2F42VF2 MXZ-2F53VF2 MXZ-2F53VFH2
MXZ-2F33VF3 MXZ-2F42VF3 MXZ-2F53VF3 MXZ-2F53VFH3

NOTE: Turn OFF the power supply before disassembly.

—>: Indicates the visible parts in the photos.
 --->: Indicates the invisible parts in the photos.

OPERATING PROCEDURE	PHOTOS
<p>1. Removing the cabinet and the panels</p> <ol style="list-style-type: none"> (1) Remove the screws fixing the service panel. (2) Pull down the service panel and remove it. (3) Disconnect the power supply and indoor/outdoor connecting wire. (4) Remove the screws fixing the top panel. (5) Remove the top panel. (6) Remove the screws fixing the cabinet. (7) Remove the cabinet. (8) Remove the screws fixing the back panel. (9) Remove the back panel. <p>Photo 2</p>	<p>Photo 1</p> <p>Photo 3</p>

OPERATING PROCEDURE

2. Removing the inverter assembly and the inverter P.C. board

- (1) Remove the service panel, the top panel and the cabinet (Refer to section 1).
- (2) Disconnect the power supply and indoor/outdoor connecting wire and remove the back panel (Refer to section 1).
- (3) Disconnect all connectors and lead wires on the inverter P.C. board.
- (4) Remove the compressor connector (CNMC).
- (5) Remove the screws fixing the heat sink support and the separator.
- (6) Remove the screws of the terminal block support and the back panel. (Photo 2)
- (7) Remove the inverter assembly.
- (8) Remove the screw of the earth wire and screws of the terminal block support.
- (9) Remove the hooks of the heat sink support and remove the heat sink support from the P.C. board support.
- (10) Remove the screw fixing the inverter P.C. board and remove the inverter P.C. board from the P.C. board support.

3. Removing the R.V. coil

- (1) Remove the service panel, the top panel and the cabinet (Refer to section 1).
- (2) Disconnect the power supply and indoor/outdoor connecting wire and remove the back panel (Refer to section 1).
- (3) Remove the inverter assembly (Refer to section 2).
- (4) Remove the R.V. coil.

4. Removing the discharge temperature thermistor, defrost thermistor and outdoor heat exchanger temperature thermistor

- (1) Remove the service panel, the top panel and the cabinet (Refer to section 1).
- (2) Disconnect the power supply and indoor/outdoor connecting wire and remove the back panel (Refer to section 1).
- (3) Remove the inverter assembly (Refer to section 2).
- (4) Pull out the discharge temperature thermistor from its holder.
- (5) Pull out the defrost thermistor from its holder (Photo 7).
- (6) Pull out the outdoor heat exchanger temperature thermistor from its holder (Photo 7).

PHOTOS

Photo 4

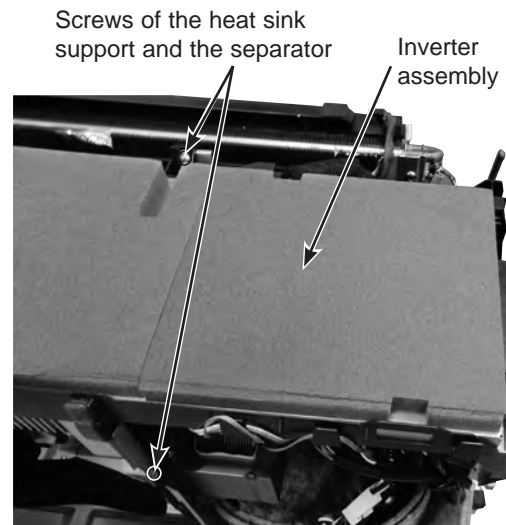

Photo 5

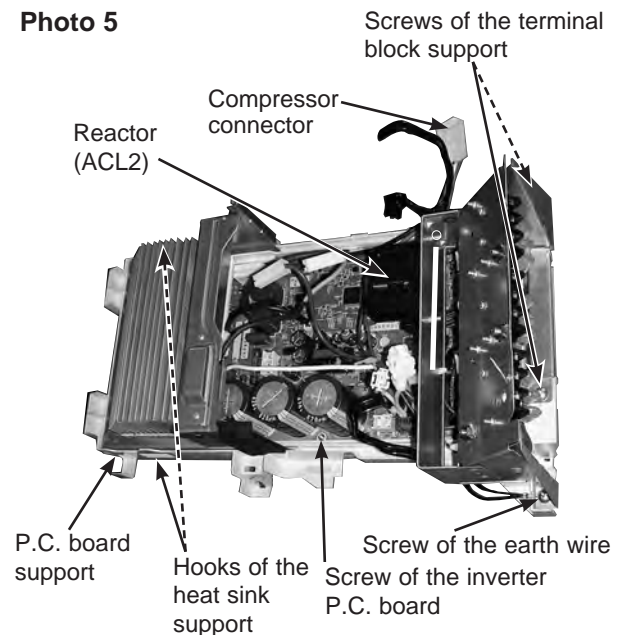
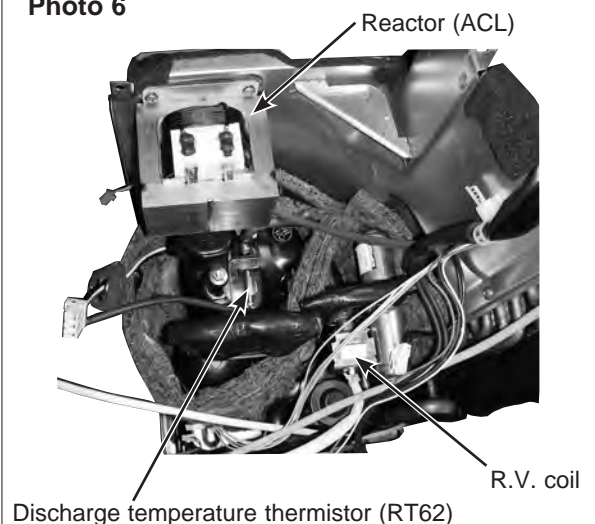

Photo 6



OPERATING PROCEDURE

5. Removing the outdoor fan motor

- (1) Remove the service panel, the top panel and the cabinet (Refer to section 1).
- (2) Disconnect the power supply and indoor/outdoor connecting wire.
- (3) Disconnect the connectors for outdoor fan motor.
- (4) Remove the propeller fan nut.
- (5) Remove the propeller fan.
- (6) Remove the screws fixing the fan motor.
- (7) Remove the fan motor.

6. Removing the compressor and the 4-way valve

- (1) Remove the service panel, the top panel and the cabinet (Refer to section 1).
- (2) Disconnect the power supply and indoor/outdoor connecting wire and remove the back panel (Refer to section 1).
- (3) Remove the inverter assembly (Refer to section 2).
- (4) Recover gas from the refrigerant circuit.

NOTE: Recover gas from the pipes until the pressure gauge shows 0 kg/cm² (0 MPa).

- (5) Detach the brazed part of the suction and the discharge pipe connected with compressor.
- (6) Remove the nuts of compressor legs.
- (7) Remove the compressor.
- (8) Detach the brazed part of pipes connected with 4-way valve.

Photo 10

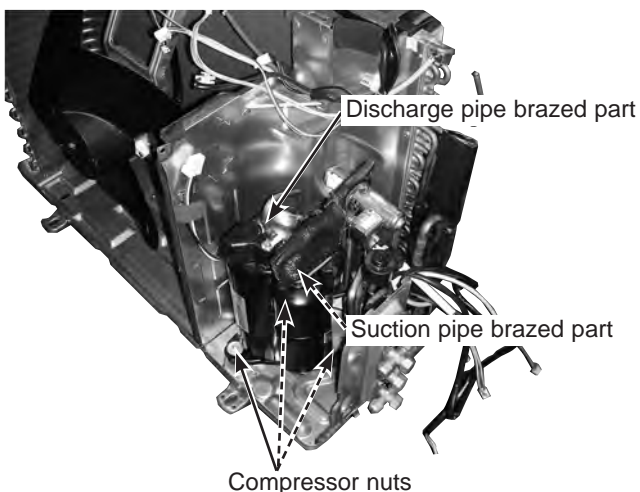

PHOTOS

Photo 7

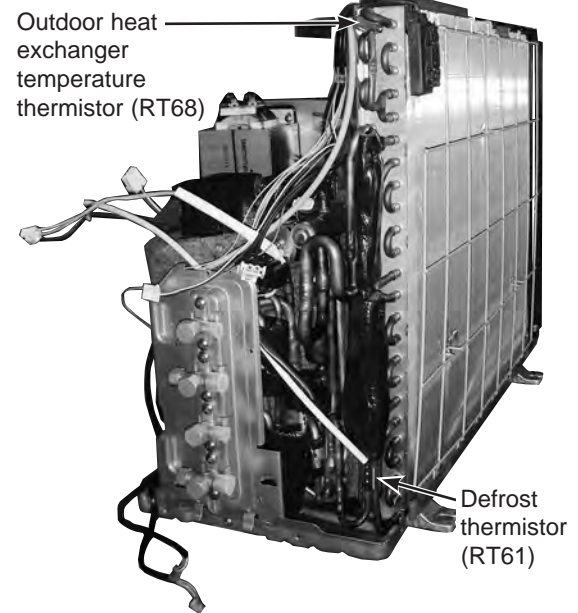

Photo 8

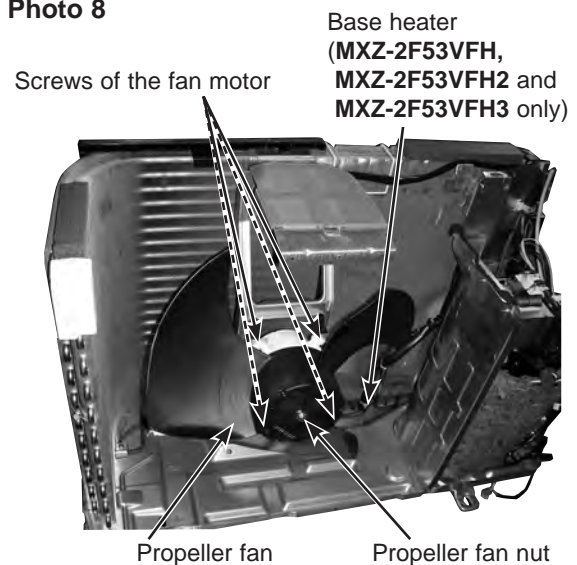
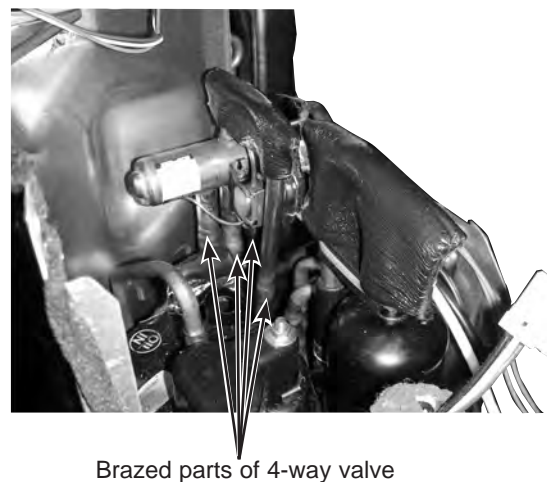
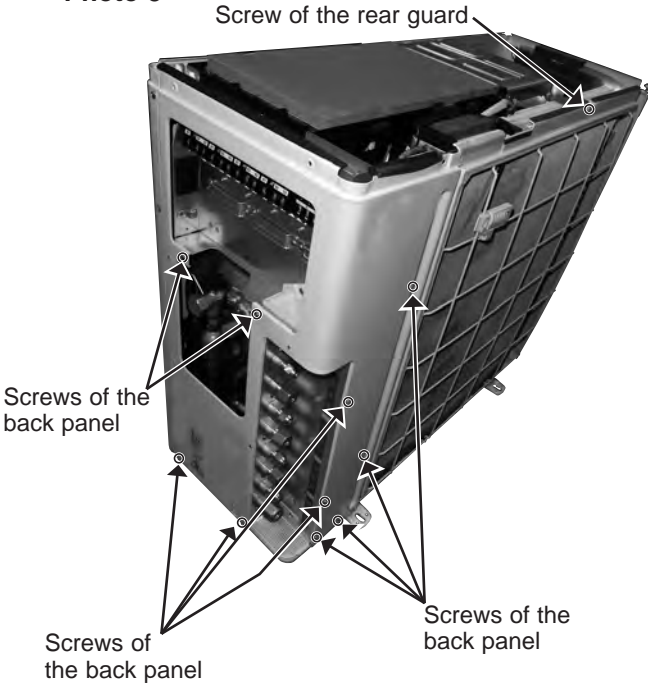
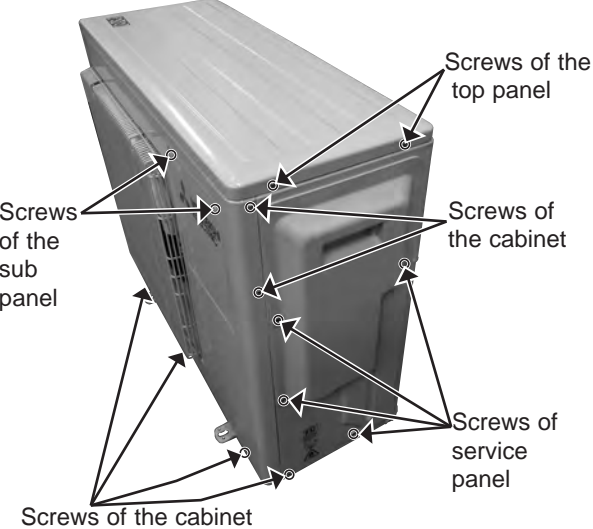
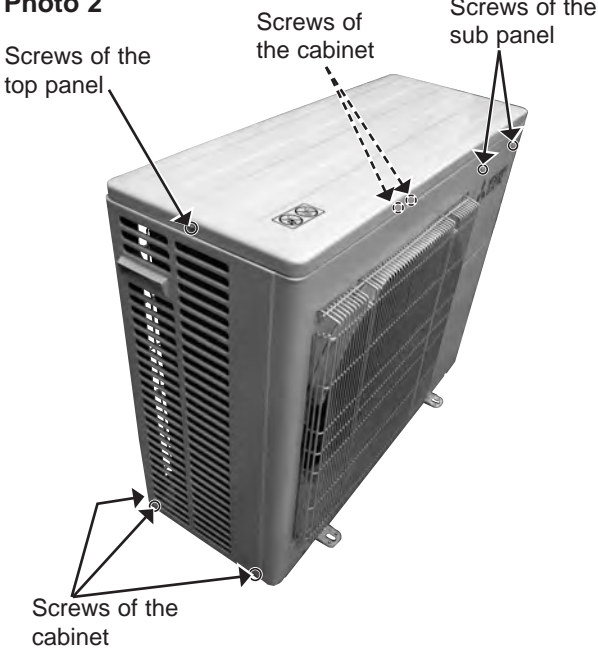

Photo 9



**13-2. MXZ-3F54VF MXZ-3F68VF MXZ-4F72VF
 MXZ-3F54VF2 MXZ-3F68VF2 MXZ-4F72VF2 MXZ-4F80VF2
 MXZ-3F54VF3 MXZ-3F68VF3 MXZ-4F72VF3 MXZ-4F80VF3**

NOTE: Turn OFF the power supply before disassembly.

OPERATING PROCEDURE	PHOTOS
<p>1. Removing the cabinet and the panels</p> <p>(1) Remove the screws of the service panel, and remove the service panel.</p> <p>(2) Disconnect the power supply and indoor/outdoor connecting wire.</p> <p>(3) Remove the screws of the top panel, and remove the top panel.</p> <p>(4) Remove the screws of the cabinet, and remove the cabinet.</p> <p>(5) Remove the screws of the back panel, and remove the back panel (Photo 3).</p> <p>Photo 3</p> 	<p>Photo 1</p>  <p>Photo 2</p> 

OPERATING PROCEDURE

2. Removing the outdoor control P.C. board, the outdoor power P.C. board and the reactor

- (1) Remove the service panel (Photo 1).
- (2) Disconnect the power supply and indoor/outdoor connecting wire.
- (3) Remove the top panel, the cabinet, and the back panel (Photo 1, 2, 3).
- (4) Disconnect all connectors and lead wires on the outdoor control P.C. board.
- (5) Unhook the catches of the outdoor control P.C. board, and remove the outdoor control P.C. board.
- (6) Remove the screws of the electrical box assembly, unhook the catches of the electrical box assembly, and remove the electrical box assembly.
- (7) Remove the screws of outdoor control P.C. board holder, and remove the outdoor control P.C. board holder.
- (8) Remove the screws of the reactor, and remove the reactor.
- (9) Remove the screws of the reactor bed, and remove the reactor bed.
- (10) Remove the screws of the heat sink support, and remove the heat sink support.
- (11) Remove the screws fixing the outdoor power P.C. board.
- (12) Disconnect all connectors and lead wires on the outdoor power P.C. board.

Photo 7

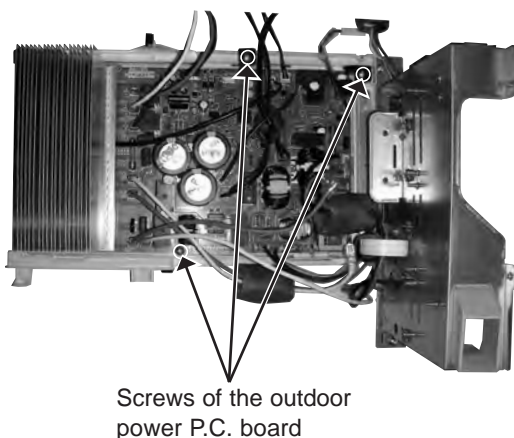

PHOTOS

Photo 4

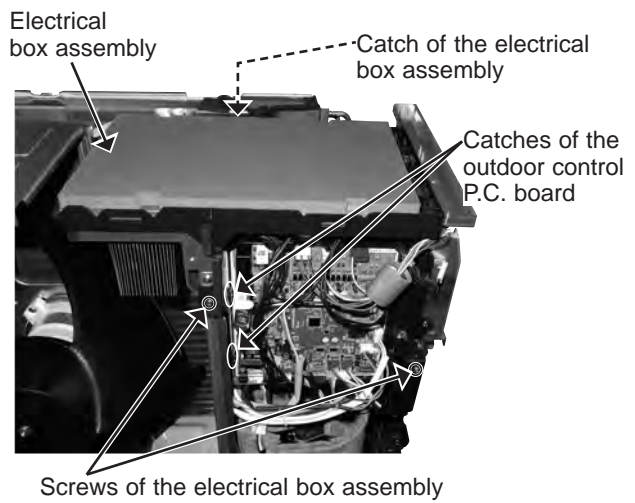
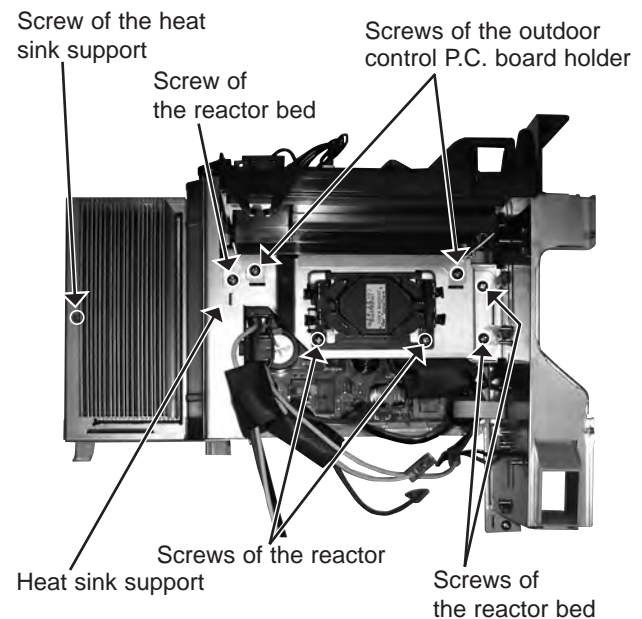

Photo 5



Photo 6



OPERATING PROCEDURE

3. Removing the fan motor

- (1) Remove the service panel (Photo 1).
- (2) Disconnect the power supply and indoor/outdoor connecting wire.
- (3) Remove the top panel, the cabinet, and the back panel (Photo 1, 2, 3).
- (4) Disconnect connectors CN712, CNF1, CNTH1, CNTH2, CN63H, CN791, CN792, CN793, CN794 (MXZ-4F72VF/4F72VF2/4F72VF3/4F80VF2/4F80VF3), CN797 on the outdoor control P.C. board and disconnect the relay connector of the compressor lead wire.
- (5) Remove the screws of the electrical box assembly, and remove the electrical box assembly (Photo 4).
- (6) Remove the propeller fan.
- (7) Remove the fan motor.

PHOTOS

Photo 8

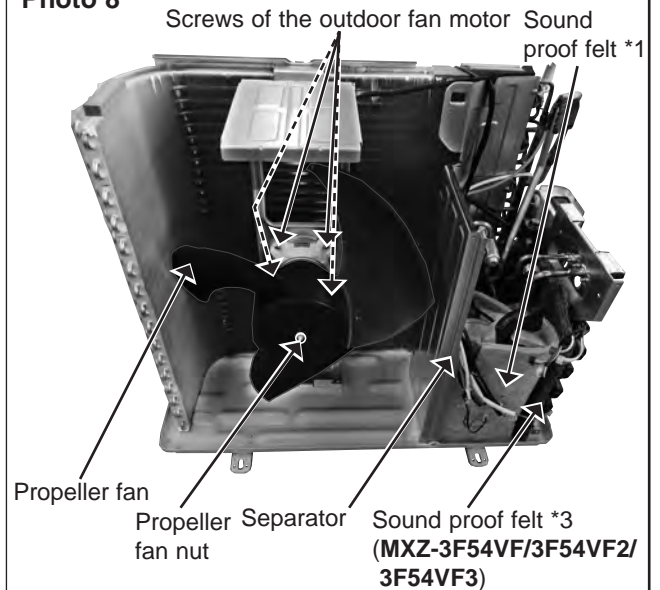

4. Removing the compressor and the 4-way valve

- (1) Remove the service panel (Photo 1).
- (2) Disconnect the power supply and indoor/outdoor connecting wire.
- (3) Remove the top panel, the cabinet, and the back panel (Photo 1, 2, 3).
- (4) Recover gas from the refrigerant circuit.
NOTE: Recover gas from the pipes until the pressure gauge shows 0 kg/cm² (0 MPa).
- (5) Disconnect the outdoor control P.C. board connectors: CN712, CNF1, CNTH1, CNTH2, CN63H, CN791, CN792, CN793, CN794 (MXZ-4F72VF/4F72VF2/4F72VF3/4F80VF2/4F80VF3), CN797.
- (6) Disconnect the compressor lead wire from the terminal of the compressor (U, V, W).
- (7) Remove the screws of the electrical box assembly, and remove the electrical box assembly (Photo 4).
- (8) Remove the propeller fan.
- (9) Remove the sound proof felt *1, *2 and *3 (MXZ-3F54VF/3F54VF2/3F54VF3).
NOTE: Before removing the sound proof felt, remove the hook-and-loop fastener of the top felt by the power receiver.
- (10) Remove the screws of the separator, and remove the separator.
- (11) Detach the brazed parts of the compressor suction and discharge pipes.
- (12) Remove the compressor nuts and remove the compressor.
- (13) Detach the brazed parts of the 4-way valve and pipe.

Photo 9

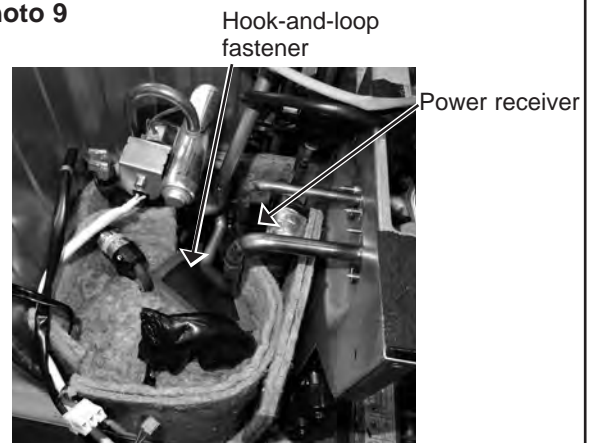
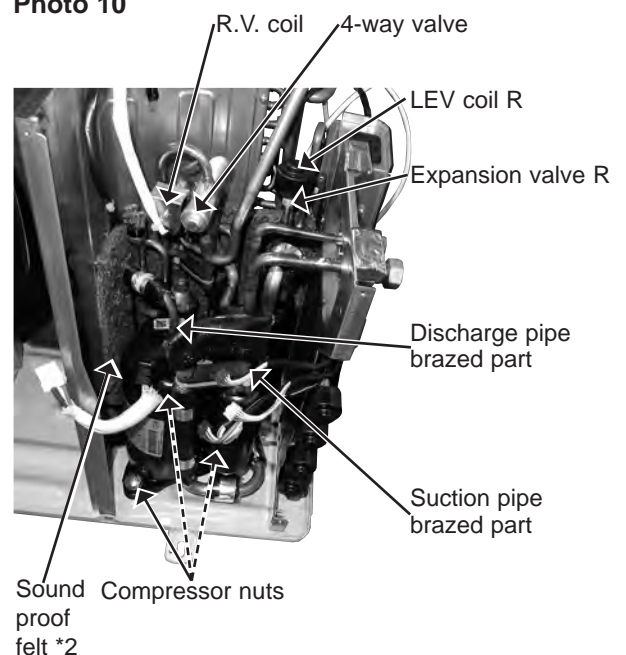

Photo 10



OPERATING PROCEDURE

5. Removing the expansion valve

- (1) Remove the service panel (Photo 1).
- (2) Remove the top panel, the cabinet, and the back panel (Photo 1, 2, 3).
(Gas recovery is not required if the unit is pumped down.)
- (3) Remove the electrical parts for removing LEV R (Photo 4, 8).
- (4) Remove the LEV coils.
- (5) Detach the brazed parts of expansion valves and pipes.

PHOTOS

Photo 11

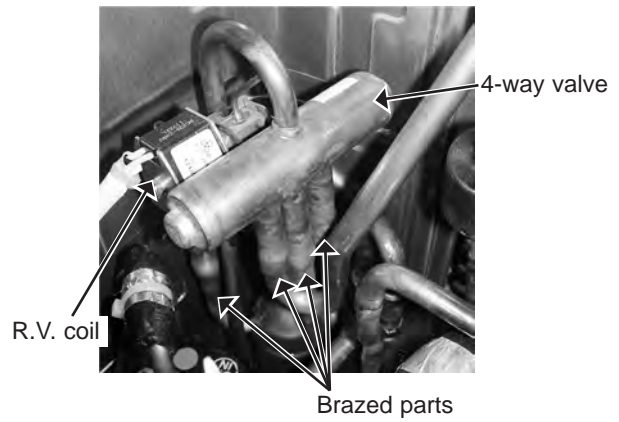
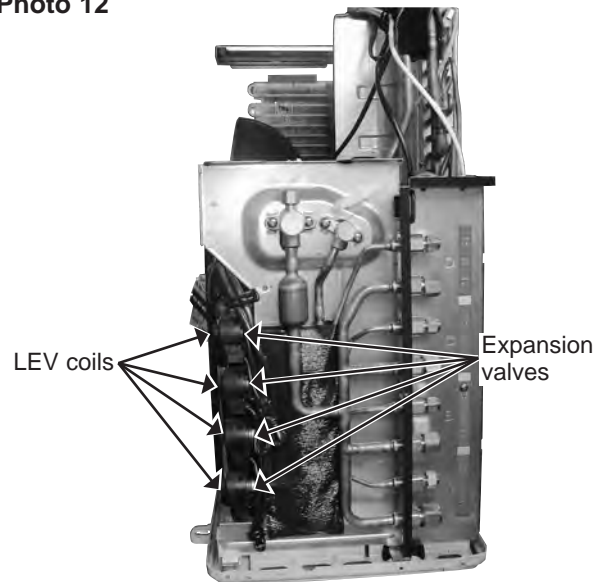
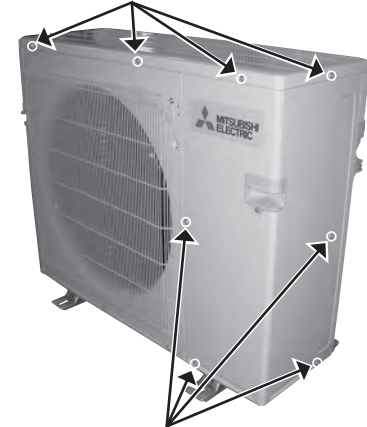
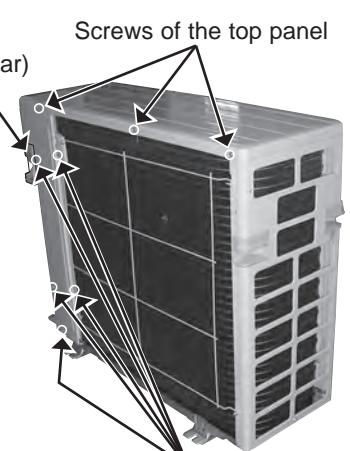
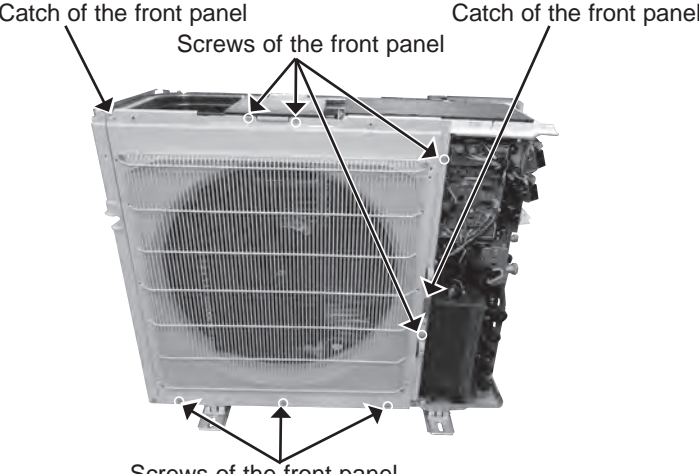
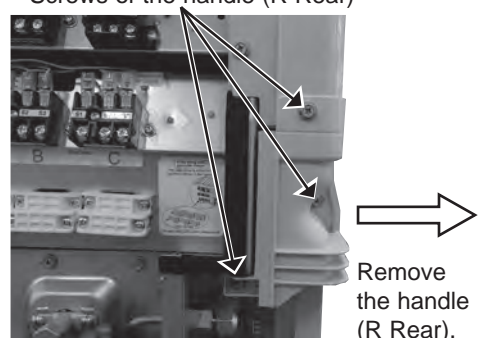
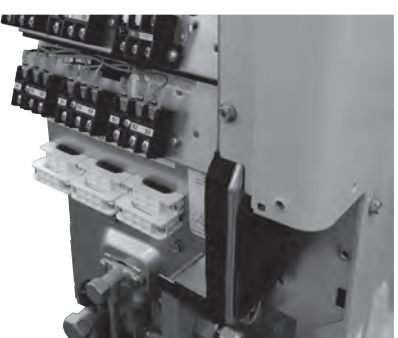

Photo 12



13-3. MXZ-4F83VF MXZ-5F102VF

NOTE: Turn OFF the power supply before disassembly.

OPERATING PROCEDURE	PHOTOS
<p>1. Removing the panels</p> <ol style="list-style-type: none"> (1) Remove the screws fixing the service panel, and remove the service panel. (2) Remove the screws fixing the top panel and remove the top panel. (3) Remove the screws fixing the handle (R Rear), and remove the handle (R Rear). (4) Disconnect the power supply and indoor/outdoor connecting wire. (5) Remove the screws fixing the front panel, and remove the front panel. (6) Remove the screws fixing the back panel, and remove the back panel. 	<p>Photo 1</p>  <p>Screws of the top panel</p> <p>Screws of the service panel</p> <p>Photo 2</p>  <p>Screws of the top panel</p> <p>Handle (R Rear)</p> <p>Screws of the back panel</p> <p>Photo 3</p>  <p>Catch of the front panel</p> <p>Screws of the front panel</p> <p>Catch of the front panel</p> <p>Screws of the front panel</p> <p>Photo 4-1</p>  <p>Screws of the handle (R Rear)</p> <p>Remove the handle (R Rear).</p> <p>Photo 4-2</p> 

OPERATING PROCEDURE

2. Removing the outdoor control P.C. board, the reactor and the outdoor power P.C. board

- (1) Remove the service panel and the top panel (Refer to section 1).
- (2) Disconnect the power supply and indoor/outdoor connecting wire.
- (3) Disconnect the connectors on the outdoor control P.C. board.
- (4) Remove the screws fixing the outdoor control P.C. board holder, and remove the outdoor control P.C. board.
- (5) Disconnect the lead wire from the reactor.
- (6) Remove the screws fixing the reactor, and remove the reactor.
- (7) Disconnect the lead wire of the power P.C. board.
- (8) Disconnect the catches of the PB cover, and remove the PB cover.
- (9) Remove the outdoor power P.C. board.

Photo 7

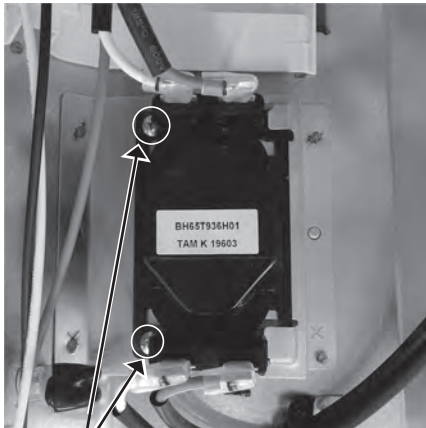

Screws of the reactor

PHOTOS

Photo 5

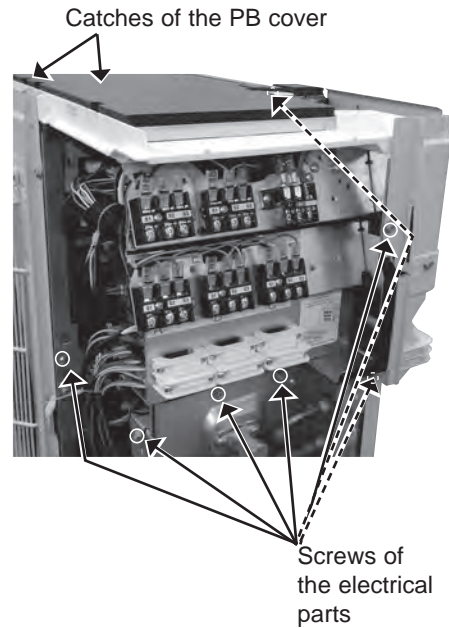
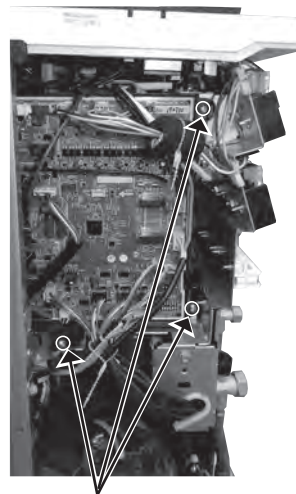

Photo 6



Screws of the outdoor control P.C. board holder

OPERATING PROCEDURE

3. Removing the fan motor

- (1) Remove the service panel, the top panel and the front panel (Refer to section 1).
- (2) Disconnect the power supply and indoor/outdoor connecting wire.
- (3) Disconnect the connector CNF1 on the outdoor control P.C. board.
- (4) Remove the propeller fan.
- (5) Remove the fan motor.

4. Removing the expansion valve

- (1) Remove the service panel and the top panel (Refer to 1).
- (2) Disconnect the power supply and indoor/outdoor connecting wire.
(Gas recovery is not required if the unit is pumped down.)
- (3) Remove the LEV coils.
- (4) Detach the brazed parts of the expansion valves and pipes.

PHOTOS

Photo 8

Propeller fan

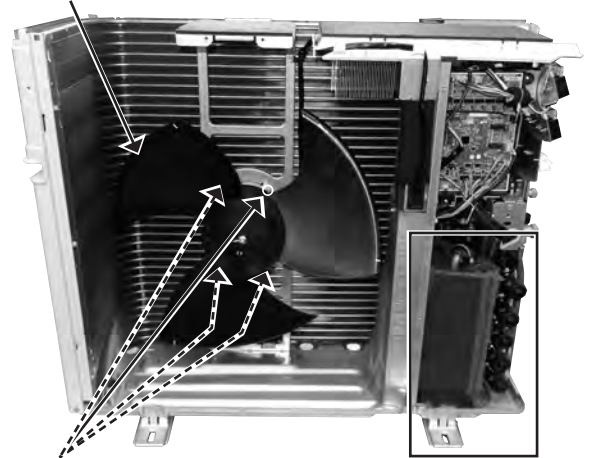

Screws of the outdoor fan motor

Photo 9

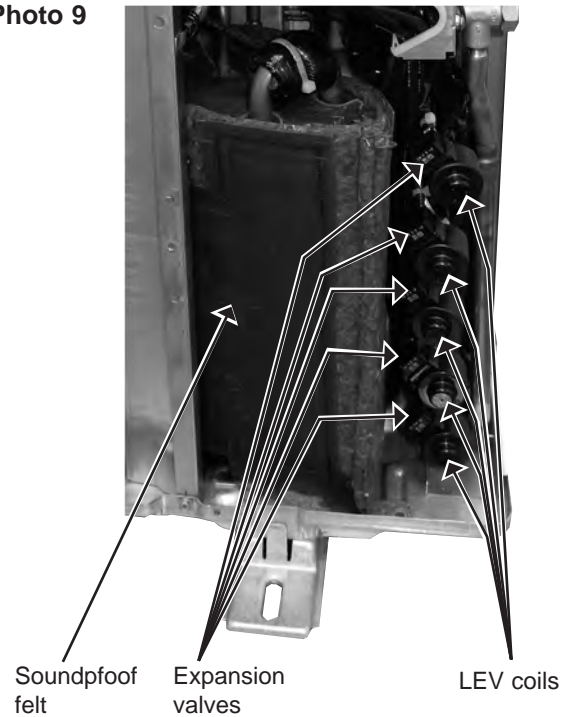

Soundproof felt

Expansion valves

LEV coils

OPERATING PROCEDURE

5. Removing the compressor and 4-way valve

- (1) Remove the service panel, the top panel, the handle (R Rear), the back panel and the front panel (Refer to section 1).
- (2) Disconnect the power supply and indoor/outdoor connecting wire, and remove the back panel.
- (3) Recover gas from the refrigerant circuit.

NOTE: Recover gas from the pipes until the pressure gauge shows 0 kg/cm² (0 MPa).

- (4) Disconnect the compressor lead wire from the terminal of the compressor (U, V, W).
- (5) Disconnect the outdoor control P.C. board connectors: CNF1, CNTH1, CNTH2, CN63H, CN712, CN791, CN792, CN793, CN794, CN795 (**MXZ-5F**)
- (6) Remove the screws fixing the electrical parts, and remove the electrical parts (Photo 5).
- (7) Remove the propeller fan.
- (8) Remove the screws fixing the separator, and remove the separator.
- (9) Remove the soundproof felt.
- (10) Detach the brazed parts of the compressor suction pipe and discharge pipe.
- (11) Remove the compressor nuts and remove the compressor.
- (12) Detach the brazed parts of 4-way valve and pipes.

PHOTOS

Photo 10

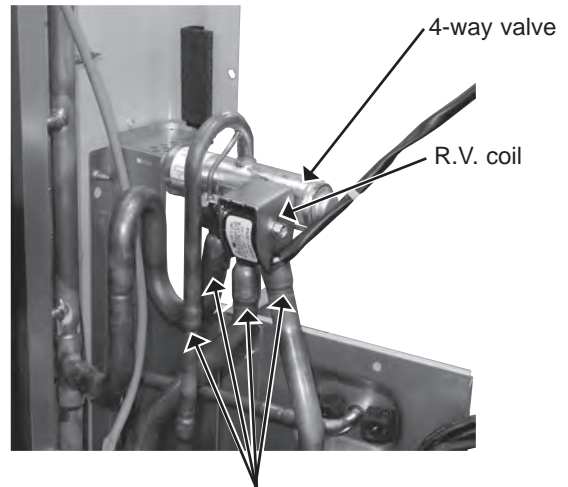

Brazed parts of 4-way valve and pipes

Photo 11

Discharge pipe brazed part

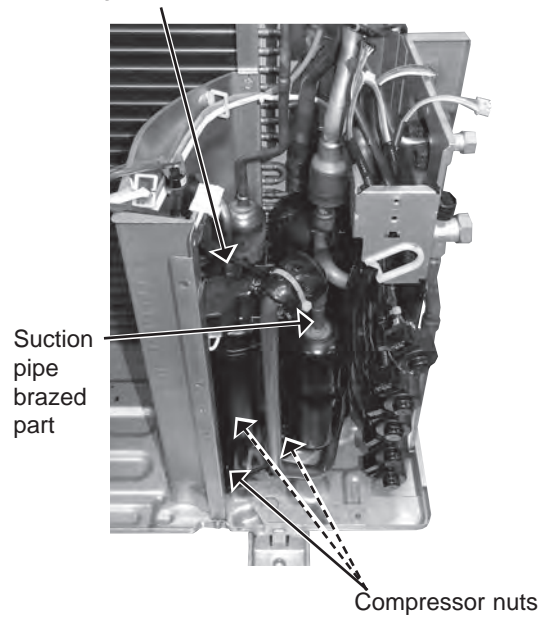

13-4. MXZ-2F53VFHZ

NOTE: Turn OFF the power supply before disassembly.

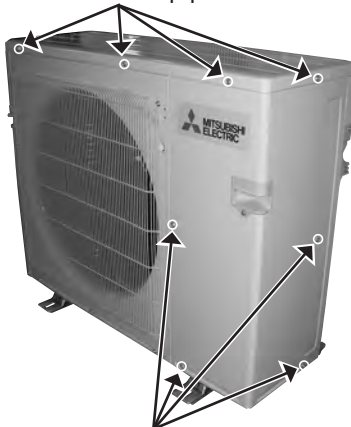
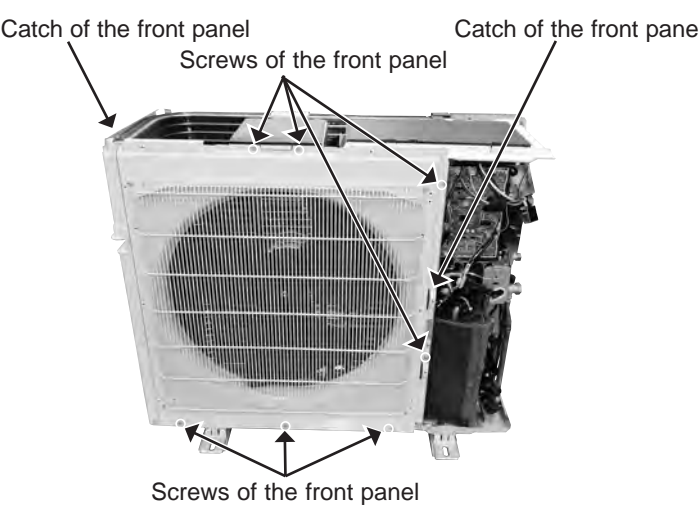
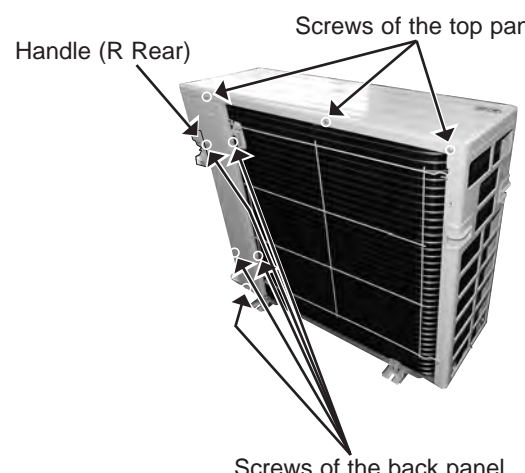
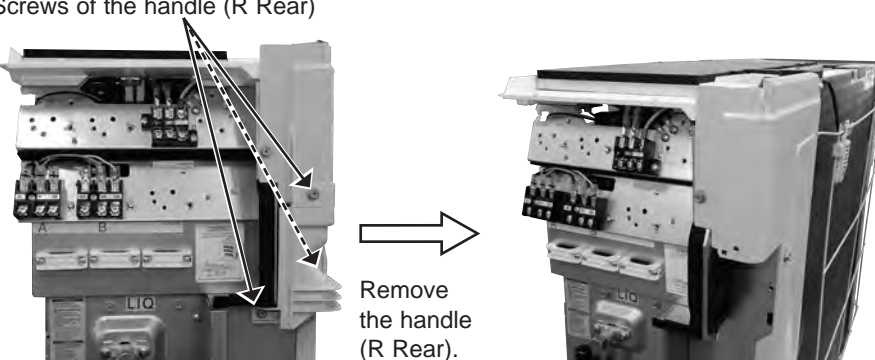
OPERATING PROCEDURE	PHOTOS
<p>1. Removing the panels</p> <ol style="list-style-type: none"> (1) Remove the screws fixing the service panel, and remove the service panel. (2) Remove the screws fixing the top panel and remove the top panel. (3) Remove the screws fixing the handle (R Rear), and remove the handle (R Rear). (4) Disconnect the power supply and indoor/outdoor connecting wire. (5) Remove the screws fixing the front panel, and remove the front panel. (6) Remove the screws fixing the back panel, and remove the back panel. 	<p>Photo 1</p> <p>Screws of the top panel</p>  <p>Screws of the service panel</p>
<p>Photo 3</p> <p>Catch of the front panel</p> <p>Screws of the front panel</p>  <p>Screws of the front panel</p>	<p>Photo 2</p> <p>Handle (R Rear)</p> <p>Screws of the top panel</p>  <p>Screws of the back panel</p>
<p>Photo 4</p> <p>Screws of the handle (R Rear)</p>  <p>Remove the handle (R Rear).</p>	

OPERATING PROCEDURE

2. Removing the outdoor control P.C. board, the reactor and the outdoor power P.C. board

- (1) Remove the service panel and the top panel (Refer to section 1).
- (2) Disconnect the power supply and indoor/outdoor connecting wire.
- (3) Disconnect the connectors on the outdoor control P.C. board.
- (4) Remove the screws fixing the outdoor control P.C. board holder, and remove the outdoor control P.C. board.
- (5) Disconnect the lead wire from the reactor.
- (6) Remove the screws fixing the reactor, and remove the reactor.
- (7) Disconnect the lead wire of the power P.C. board.
- (8) Disconnect the catches of the PB cover, and remove the PB cover.
- (9) Remove the outdoor power P.C. board.

Photo 7

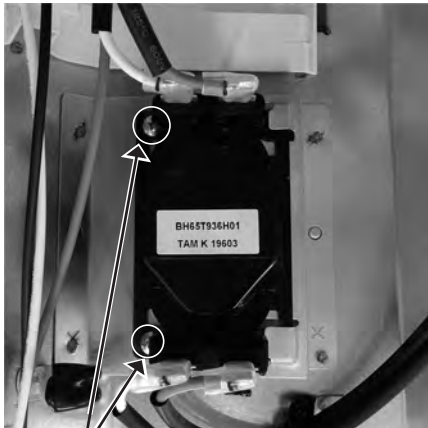

Screws of the reactor

PHOTOS

Photo 5

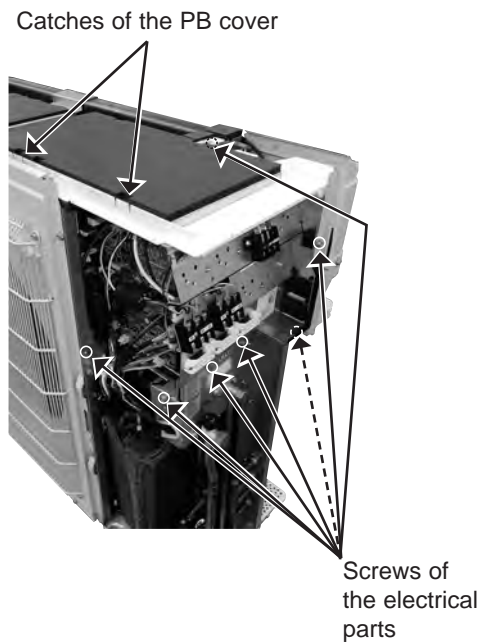
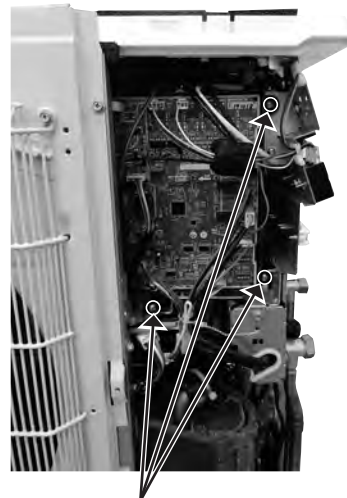

Photo 6



Screws of the outdoor control P.C. board holder

OPERATING PROCEDURE

3. Removing the fan motor

- (1) Remove the service panel, the top panel and the front panel (Refer to section 1).
- (2) Disconnect the power supply and indoor/outdoor connecting wire.
- (3) Disconnect the connector CNF1 on the outdoor control P.C. board.
- (4) Remove the propeller fan.
- (5) Remove the fan motor.

4. Removing the expansion valve

- (1) Remove the service panel and the top panel (Refer to section 1).
- (2) Disconnect the power supply and indoor/outdoor connecting wire.
(Gas recovery is not required if the unit is pumped down.)
- (3) Remove the LEV coils.
- (4) Detach the brazed parts of the expansion valves and pipes.

5. Removing the defrost heater

- (1) Remove the service panel, the top panel and the front panel (Refer to section 1).
- (2) Disconnect the power supply and indoor/outdoor connecting wire.
- (3) Disconnect the defrost heater lead wires from CN714 on the outdoor control P.C. board.
- (4) Remove the defrost heater lead wires from the lead clamp.
- (5) Remove the screws of the defrost heater.
- (6) Remove the heater protector and the defrost heater.

PHOTOS

Photo 8

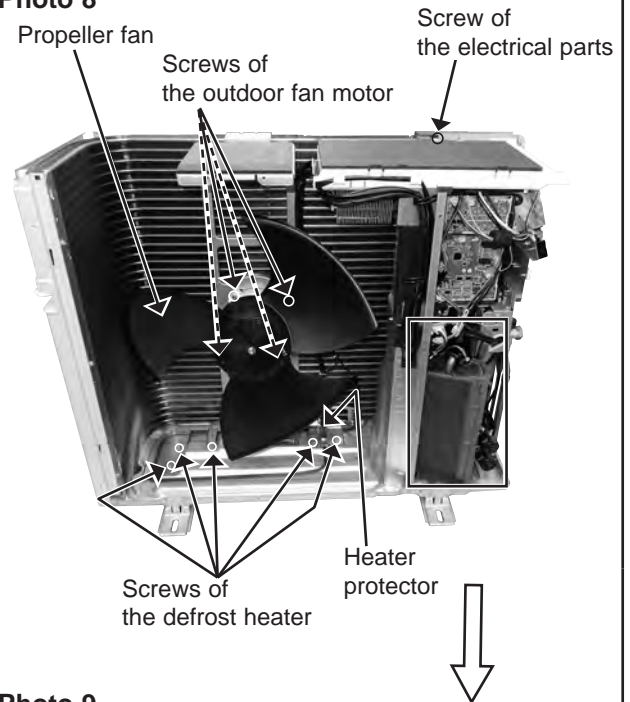
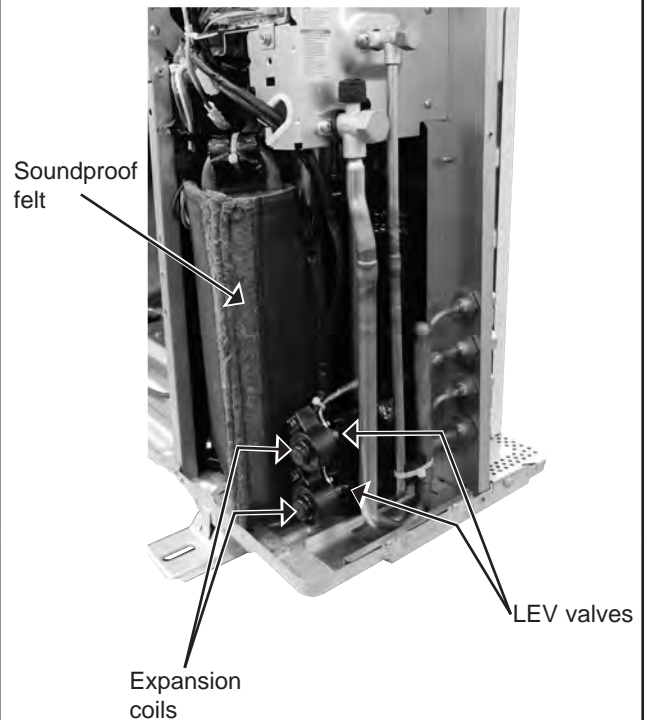

Photo 9



OPERATING PROCEDURE

6. Removing the compressor and 4-way valve

- (1) Remove the service panel, the top panel, the handle (Rear), the back panel and the front panel (Refer to section 1).
- (2) Disconnect the power supply and indoor/outdoor connecting wire, and remove the back panel.
- (3) Recover gas from the refrigerant circuit.

NOTE: Recover gas from the pipes until the pressure gauge shows 0 kg/cm² (0 MPa).

- (4) Disconnect the compressor lead wire from the terminal of the compressor (U, V, W).
- (5) Disconnect the outdoor control P.C. board connectors: CNF1, CNTH1, CNTH2, CN63H, CN712, CN791, CN792, CN714
- (6) Remove the screws fixing the electrical parts, and remove the electrical parts (Photo 5).
- (7) Remove the propeller fan.
- (8) Remove the screws fixing the separator, and remove the separator.
- (9) Remove the soundproof felt.
- (10) Detach the brazed parts of the compressor suction pipe and discharge pipe.
- (11) Remove the compressor nuts and remove the compressor.
- (12) Detach the brazed parts of 4-way valve and pipes.

PHOTOS

Photo 10

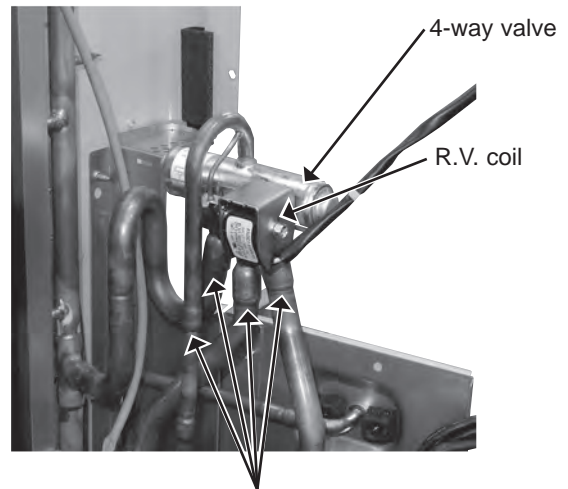

Brazed parts of 4-way valve and pipes

Photo 11

Discharge pipe brazed part

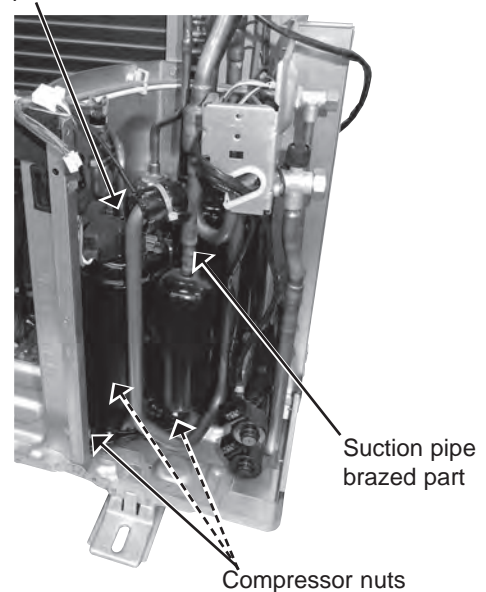

Suction pipe brazed part

Compressor nuts

13-5. MXZ-4F83VFHZ

NOTE: Turn OFF the power supply before disassembly.

OPERATING PROCEDURE

1. Removing the panels

- (1) Remove the screws fixing the service panel, and remove the service panel.
- (2) Remove the screws fixing the top panel, remove the top panel.
- (3) Disconnect the power supply and indoor/outdoor connecting wire.
- (4) Remove the screws fixing the front panel, and remove the front panel.
- (5) Remove the screws fixing the back panel, and remove the back panel.

Photo 3

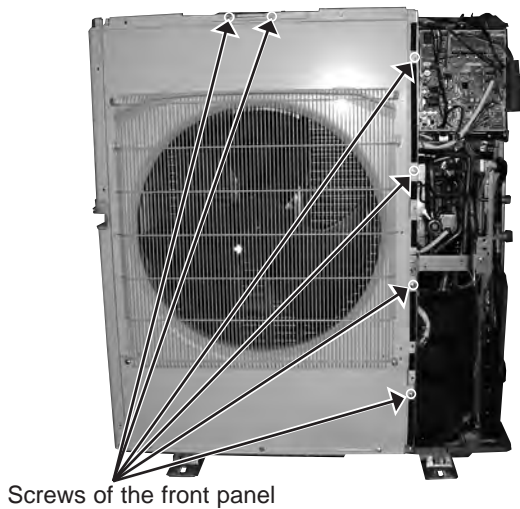

PHOTOS

Photo 1

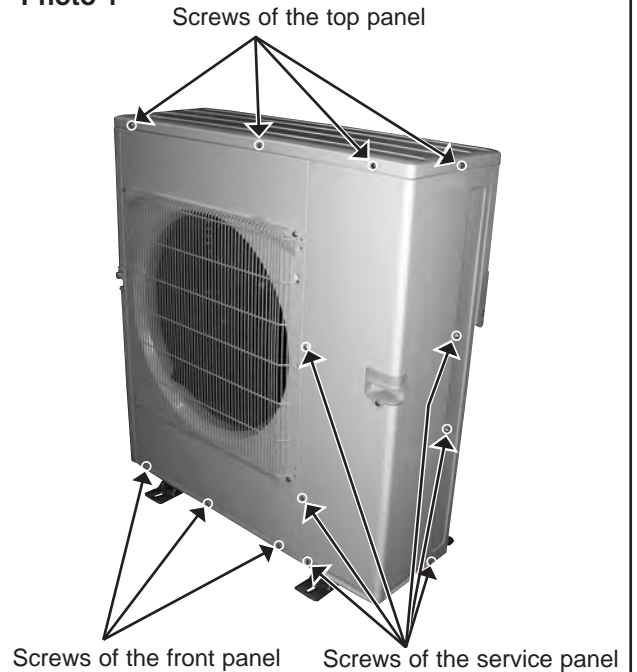

Photo 2



OPERATING PROCEDURE

2. Removing the outdoor control P.C. board, the reactor and the outdoor power P.C. board

- (1) Remove the service panel, the top panel and the front panel (Refer to section 1).
- (2) Disconnect the power supply and indoor/outdoor connecting wire.
- (3) Disconnect the connectors on the outdoor control P.C. board.
- (4) Remove the screws fixing the outdoor control P.C. board, and remove the outdoor control P.C. board.
- (5) Remove the screws fixing the electrical parts, and remove the electrical parts.
- (6) Remove the screws fixing the TB support, and remove the TB support.
- (7) Remove the screws fixing the control box separator, and remove the control box separator.
- (8) Disconnect the lead wire of the outdoor power P.C. board.
- (9) Remove the screws fixing the outdoor power P.C. board, and remove the outdoor power P.C. board with the outdoor P.C. board holder.
- (10) Remove the screws fixing the control box F, and remove the control box F.
- (11) Remove the screws fixing the reactors, and remove the reactors.

Photo 7



Screws of the control box F

Photo 8

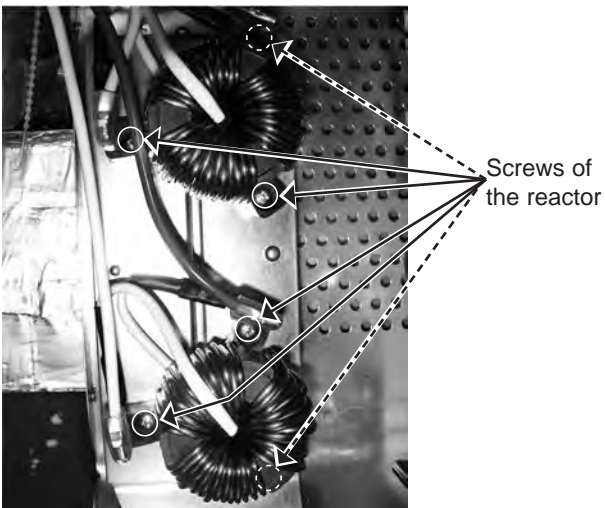

Screws of the reactor

PHOTOS

Photo 4

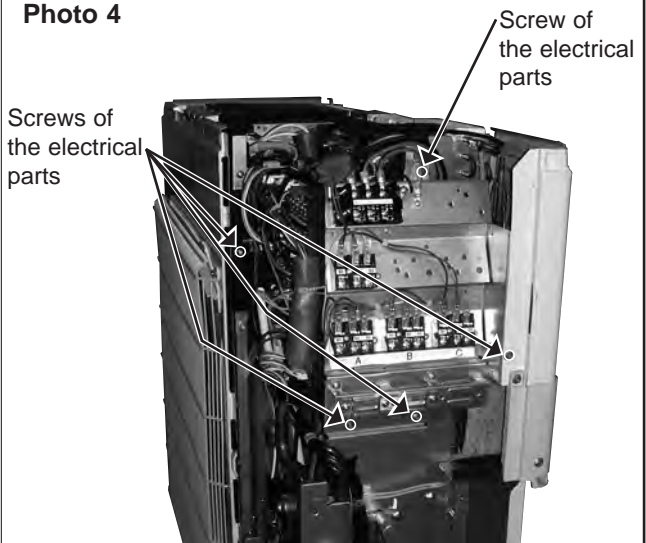

Screw of the electrical parts

Screws of the electrical parts

Photo 5

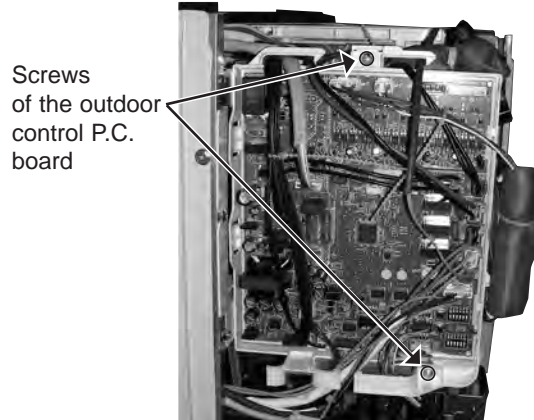

Screws of the outdoor control P.C. board

Photo 6

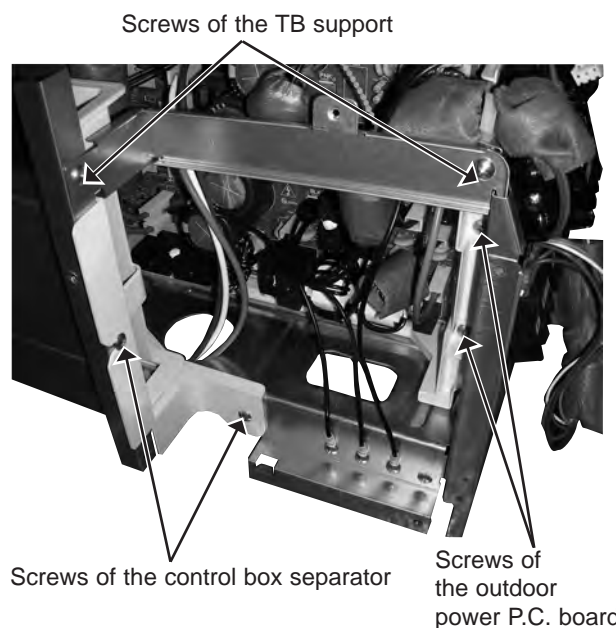

Screws of the TB support

Screws of the control box separator

Screws of the outdoor power P.C. board

OPERATING PROCEDURE

3. Removing the fan motor

- (1) Remove the service panel, the top panel and the front panel (Refer to section 1).
- (2) Disconnect the power supply and indoor/outdoor connecting wire.
- (3) Disconnect the connector CNF1 on the outdoor control P.C. board.
- (4) Remove the propeller fan.
- (5) Remove the fan motor.

4. Removing the expansion valve

- (1) Remove the service panel and the top panel (Refer to section 1).
- (2) Disconnect the power supply and indoor/outdoor connecting wire.
(Gas recovery is not required if the unit is pumped down.)
- (3) Remove the LEV coils.
- (4) Detach the brazed parts of expansion valves and pipes.

5. Removing the defrost heater

- (1) Remove the service panel, the top panel and the front panel (Refer to section 1).
- (2) Disconnect the power supply and indoor/outdoor connecting wire.
- (3) Disconnect the defrost heater lead wires from CN714 on the outdoor control P.C. board.
- (4) Remove the defrost heater lead wires from the lead clamp.
- (5) Remove the screws of the defrost heater.
- (6) Remove the heater protector and the defrost heater.

PHOTOS

Photo 9

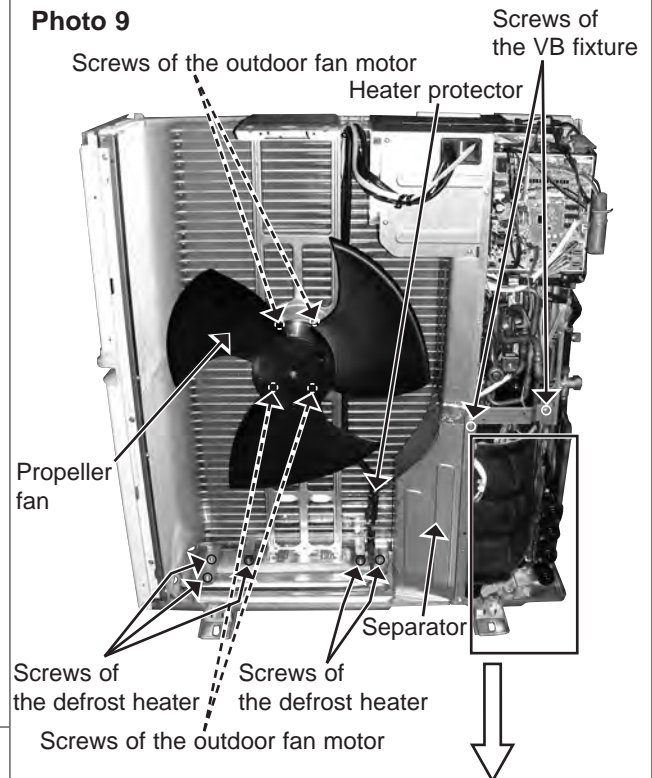
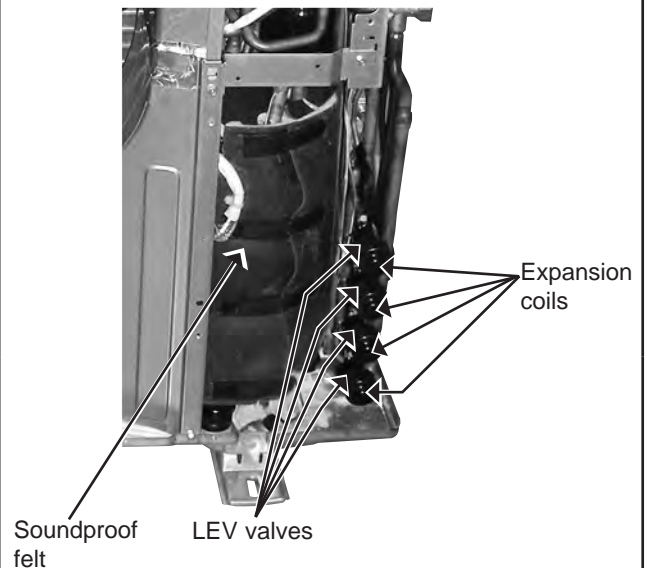

Photo 10



OPERATING PROCEDURE

6. Removing the compressor and 4-way valve

- (1) Remove the service panel, the top panel, the back panel and the front panel (Refer to section 1).
- (2) Disconnect the power supply and indoor/outdoor connecting wire, and remove the back panel.
- (3) Recover gas from the refrigerant circuit.
NOTE: Recover gas from the pipes until the pressure gauge shows 0 kg/cm² (0 MPa).
- (5) Disconnect the compressor lead wire from the terminal of the compressor (U, V, W).
- (6) Disconnect the outdoor control P.C. board connectors: CNF1, CNTH1, CNTH2, CN63H, CN712, CN713, CN714, CN791, CN792, CN793, CN794
- (7) Remove the screws fixing the electrical parts, and remove the electrical parts (Photo 4).
- (8) Remove the propeller fan.
- (9) Remove the screws fixing the VB fixture, and remove the VB fixture.
- (10) Remove the screws fixing the separator, and remove the separator.
NOTE: When installing the separator, insert the tabs of the heat exchanger into the separator.
- (11) Remove the soundproof felt.
- (12) Detach the brazed parts of the suction pipe and discharge pipe.
- (13) Remove the nuts of the compressor, and remove the compressor.
- (14) Detach the brazed parts of 4-way valve and pipes.

PHOTOS

Photo 11



4-way valve

R.V. coil

Brazed parts of 4-way valve and pipes

Photo 12

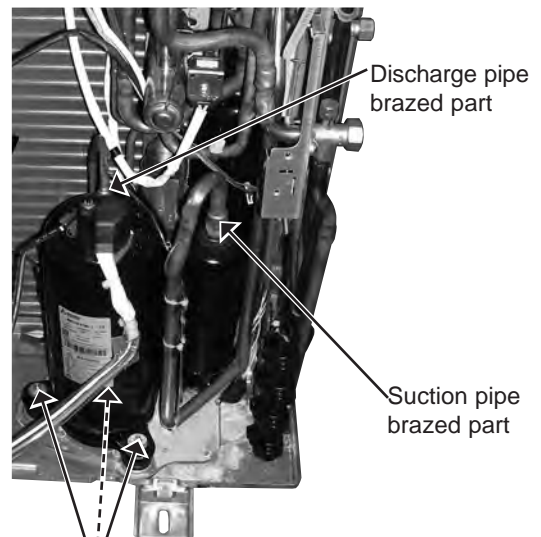

Discharge pipe brazed part

Suction pipe brazed part

Compressor nuts

13-6. MXZ-6F122VF

NOTE: Turn OFF the power supply before disassembly.

OPERATING PROCEDURE

1. Removing the panels

- (1) Remove the screws fixing the service panel, and remove the service panel.
- (2) Remove the screws fixing the top panel, remove the top panel.
- (3) Disconnect the power supply cord and indoor/outdoor connecting wire.
- (4) Remove the screws fixing the front panel, and remove the front panel.
- (5) Remove the screws fixing the back panel, and remove the back panel.

Photo 3

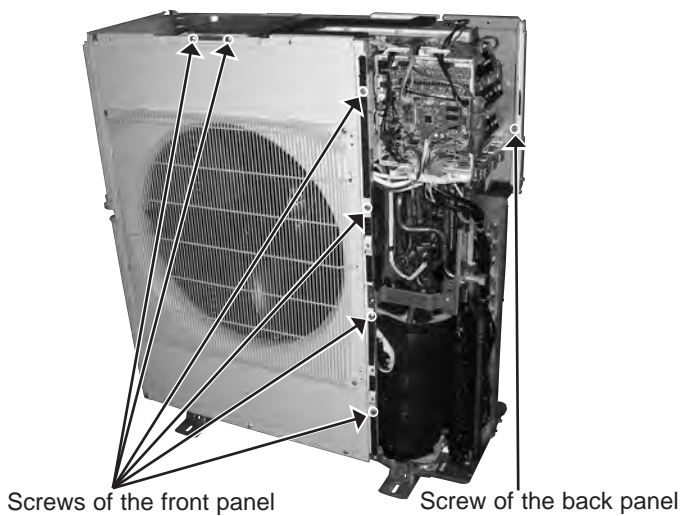

PHOTOS/FIGURES

Photo 1

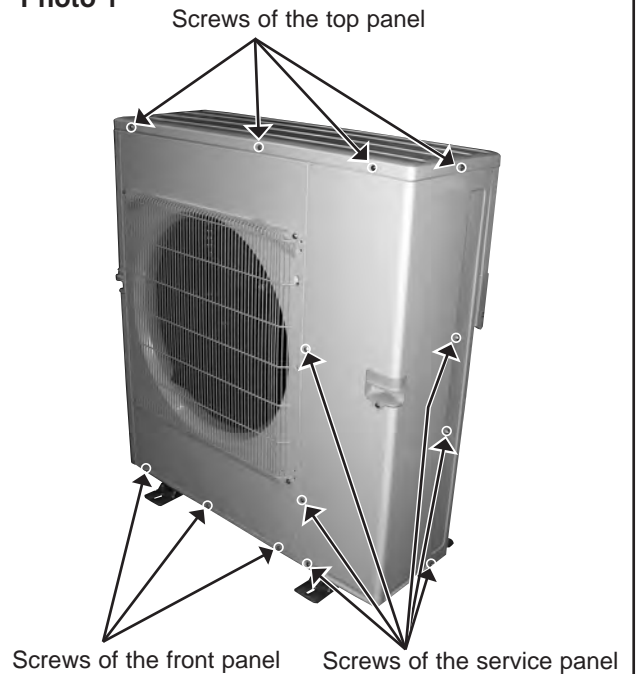
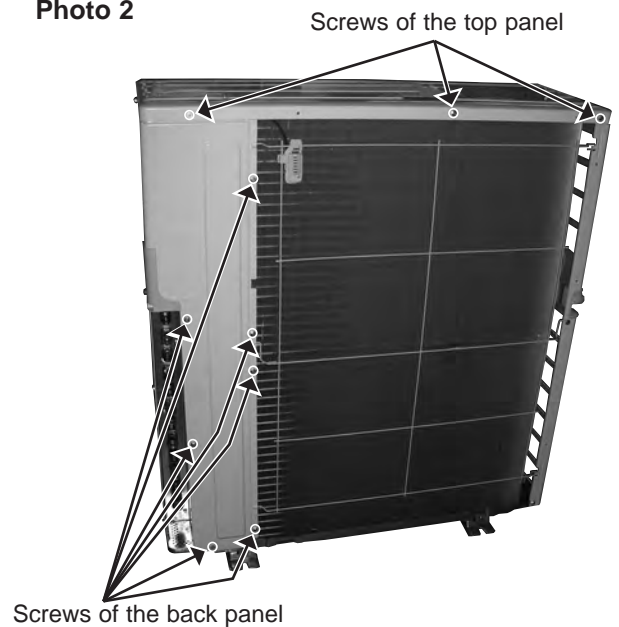

Photo 2



OPERATING PROCEDURE

2. Removing the outdoor control P.C. board, the reactor and the outdoor power P.C. board

- (1) Remove the service panel, the top panel and the front panel (Refer to section 1).
- (2) Disconnect the power supply cord and indoor/outdoor connecting wire.
- (3) Disconnect the connectors on the outdoor control P.C. board.
- (4) Remove the screws fixing the outdoor control P.C. board, and remove the outdoor control P.C. board.
- (5) Remove the screws fixing the electrical parts, and remove the electrical parts.
- (6) Remove the screws fixing the TB support, and remove the TB support.
- (7) Remove the screws fixing the control box separator, and remove the control box separator.
- (8) Disconnect the lead wire of the outdoor power P.C. board.
- (9) Remove the screws fixing the outdoor power P.C. board, and remove the outdoor power P.C. board with the outdoor P.C. board holder.
- (10) Remove the screws fixing the control box F, and remove the control box F.
- (11) Remove the screws fixing the reactors, and remove the reactors.

Photo 7



Screws of the control box F

Photo 8

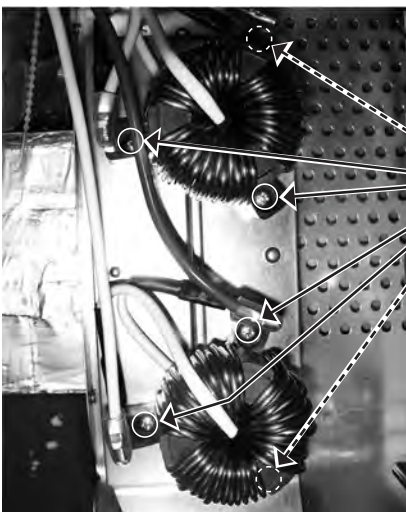

Screws of the reactor

PHOTOS/FIGURES

Photo 4

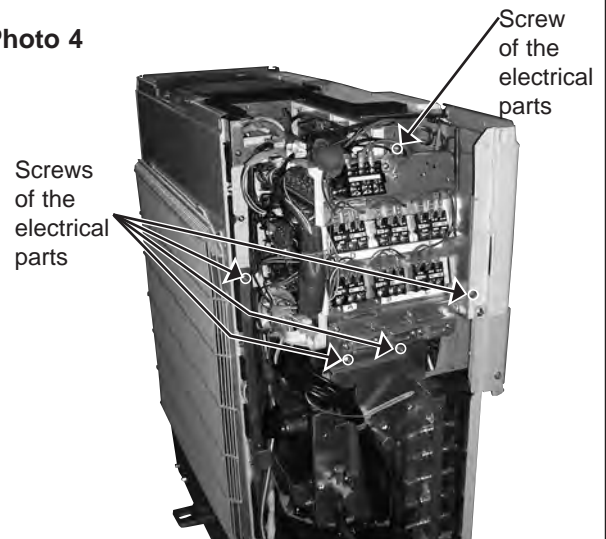

Screws of the electrical parts

Screw of the electrical parts

Photo 5

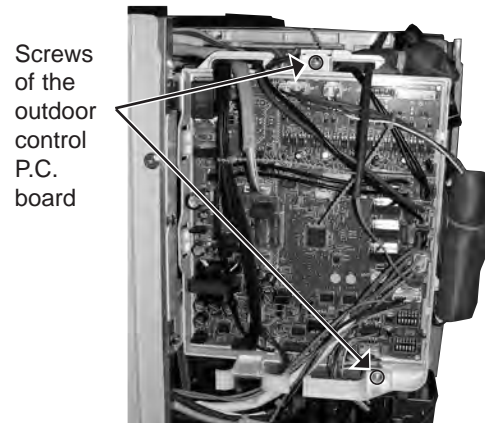

Screws of the outdoor control P.C. board

Photo 6

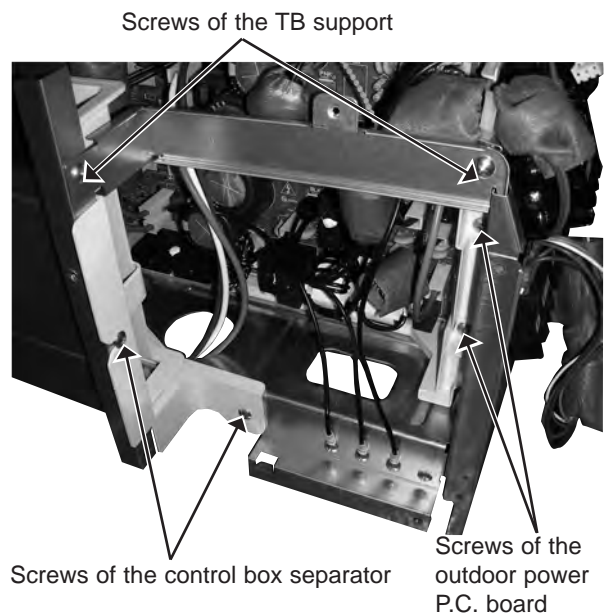

Screws of the TB support

Screws of the control box separator

Screws of the outdoor power P.C. board

OPERATING PROCEDURE

3. Removing the fan motor

- (1) Remove the service panel, the top panel and the front panel (Refer to section 1).
- (2) Disconnect the power supply cord and indoor/outdoor connecting wire.
- (3) Disconnect the connector CNF1 on the outdoor control P.C. board.
- (4) Remove the propeller fan.
- (5) Remove the fan motor.

4. Removing the compressor and 4-way valve

- (1) Remove the service panel, the top panel, the back panel and the front panel (Refer to section 1).
- (2) Disconnect the power supply cord and indoor/outdoor connecting wire, and remove the back panel.
- (3) Recover gas from the refrigerant circuit.
NOTE: Recover gas from the pipes until the pressure gauge shows 0 kg/cm² (0 MPa).
- (5) Disconnect the compressor lead wire from the terminal of the compressor (U, V, W).
- (6) Disconnect the outdoor control P.C. board connectors: CNF1, CNTH1, CNTH2, CN63H, CN712, CN713, CN714, CN791, CN792, CN793, CN794, CN795
- (7) Remove the screws fixing the electrical parts, and remove the electrical parts (Photo 4).
- (8) Remove the propeller fan.
- (9) Remove the screws fixing the VB fixture, and remove the VB fixture.
- (10) Remove the screws fixing the separator, and remove the separator.
NOTE: When installing the separator, insert the tabs of the heat exchanger into the separator.
- (11) Remove the sound proof felt.
- (12) Detach the brazed parts of the suction and discharge pipes (Photo 11).
- (13) Remove the nuts of the compressor, and remove the compressor (Photo 11).
- (14) Detach the brazed parts of 4-way valve and pipes.

PHOTOS/FIGURES

Photo 9

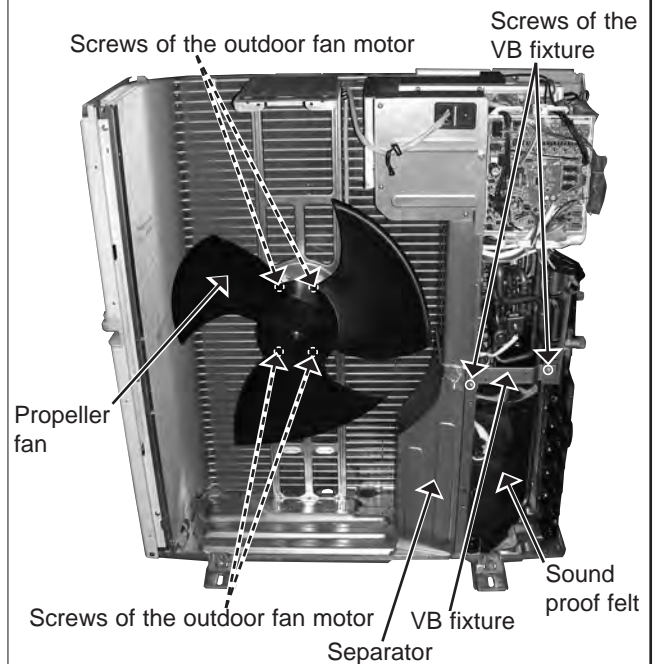
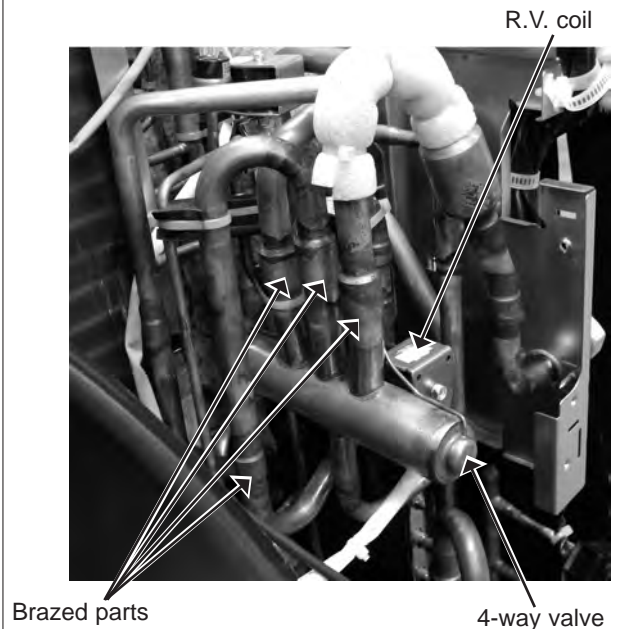
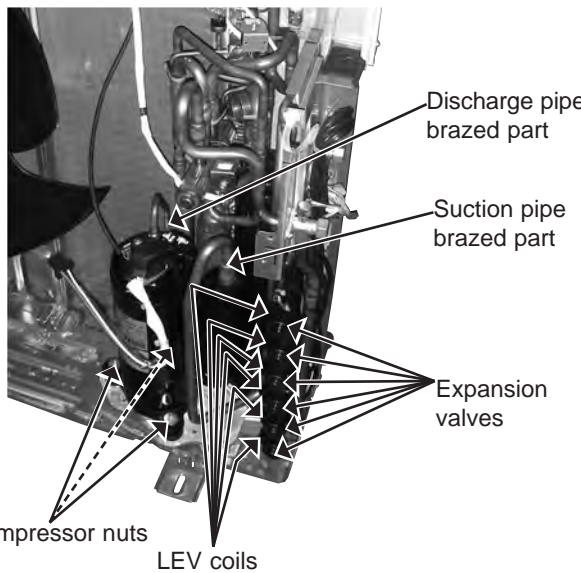

Photo 10





OPERATING PROCEDURE	PHOTOS/FIGURES
<p>5. Removing the expansion valve</p> <p>(1) Remove the service panel and the top panel (Refer to section 1).</p> <p>(2) Disconnect the power supply cord and indoor/outdoor connecting wire. (Gas recovery is not required if the unit is pumped down.)</p> <p>(3) Remove the LEV coils.</p> <p>(4) Detach the brazed parts of expansion valves and pipes.</p>	<p>Photo 11</p>  <p>Discharge pipe brazed part</p> <p>Suction pipe brazed part</p> <p>Expansion valves</p> <p>LEV coils</p> <p>Compressor nuts</p>

MITSUBISHI ELECTRIC CORPORATION

HEAD OFFICE: TOKYO BUILDING, 2-7-3, MARUNOUCHI, CHIYODA-KU, TOKYO 100-8310, JAPAN

© Copyright 2018 MITSUBISHI ELECTRIC CORPORATION

Issued: Feb. 2021. No.OBH790 REVISED EDITION-G

Issued: Jul. 2020. No.OBH790 REVISED EDITION-F

Issued: Mar. 2020. No.OBH790 REVISED EDITION-E

Issued: Nov. 2019. No.OBH790 REVISED EDITION-D

Issued: May 2019. No.OBH790 REVISED EDITION-C

Issued: Feb. 2019. No.OBH790 REVISED EDITION-B

Issued: Sep. 2018. No.OBH790 REVISED EDITION-A

Published: Mar. 2018. No.OBH790

Made in Japan

Specifications are subject to change without notice.