

KOMFORT RoTo EC D S21

Suspended heat recovery air handling units

Features

- Air handling units for efficient supply and exhaust ventilation in flats, houses, cottages and other buildings.
- Heat recovery is provided by the rotary heat exchanger and minimizes ventilation heat losses.
- Controllable air exchange for creating the best suitable indoor microclimate.
- Compatible with round Ø 160 and 200 mm air ducts.
- Additional spigot for kitchen hood air duct connection.



Air flow:
up to 710 m³/h
197 l/s



Heat recovery efficiency:
up to 87 %



Design

- The fan casing is made of galvanized steel, internally filled with mineral wool layer for heat and sound insulation.
- The spigots are located at the sides of the unit and are rubber sealed for airtight connection to the air ducts.
- **KOMFORT Roto EC D(2)** – model without electric heater.
- **KOMFORT Roto EC D(2)E** – model with electric heater.
- The insulation of **KOMFORT Roto EC D(E)** is 40 mm, for **KOMFORT Roto EC D2(E)** is 20 mm.
- Unit maintenance is performed from the bottom panel side.
- The distinctive feature of **KOMFORT Roto EC D2(E)** is a low casing profile.

Kitchen hood

- All the models are equipped with a fifth spigot for connection of the air duct from the kitchen hood.

Air filtration

- Two built-in filters with G4 and F7 filtration class provide efficient supply air filtration. Optionally, a H13 supply air filter may be used.
- The G4 filter is used for extract air filtration.

Motors

- High-efficient external rotor EC motors and centrifugal impellers with forward curved blades are used for air supply and exhaust.
- EC motors have the best power consumption to air flow ratio and meet the latest demands concerning energy saving and high-efficient ventilation.
- EC motors are featured with high performance, low noise level and totally controllable speed range.
- Dynamically balanced impellers.

AIR HANDLING UNITS WITH ROTARY HEAT EXCHANGER



KOMFORT ROTO EC D(E) R (RIGHT SERVICE SIDE)

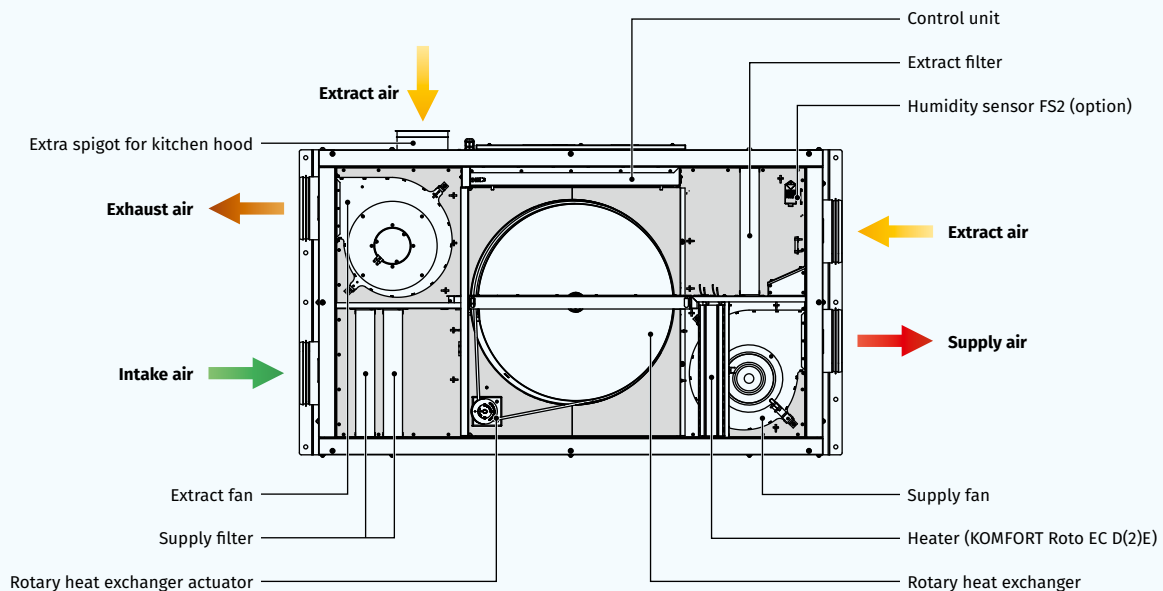

Rotary heat exchanger

- The unit has a high-efficient rotary aluminium heat exchanger.
- The rotary heat exchanger is a short, rotating cylinder, filled with corrugated aluminium sheet layers. The air streams flow through them.
- The band layers of the heat exchanger first come in contact with the supply and then with extract air flows.
- Therefore the band is alternatively warmed up and cooled down and the extract air heat and humidity are transferred to the cold intake air. This way heat recovery reduces heat losses in the cold season and reduces operation load for air conditioner in the warm season.
- The advantages of the rotary heat exchanger as compared to the plate heat exchangers include no condensate generation, maintaining comfort air humidity and high freeze resistance.

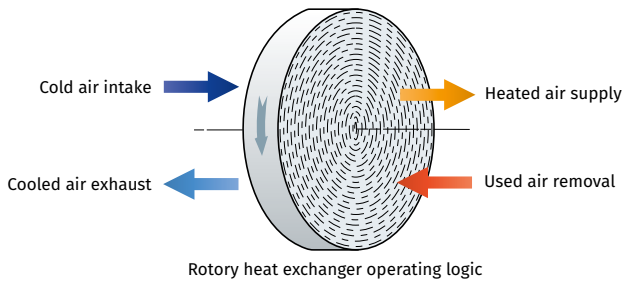

Heater

- The **KOMFORT Roto EC D(2)E** units are equipped with the electric heater. If the necessary temperature level of the supply air cannot be achieved through heat recovery, the heater turns on automatically and heats the air supplied to the premise. The heaters incorporate protective measures securing the safe unit operation.

Mounting

- The air handling unit is designed for suspension to a ceiling, wall mounting or mounting to a horizontal plane.

Control and automation

- **KOMFORT EC D... S21** units are equipped with an integrated automation system. The remote control panel is not included in the delivery set (purchased separately).
- The S21 controller allows integrating the unit into the **Smart Home** system or **BMS (Building Management System)**.
- The unit can be controlled via the **Blauberg AHU** mobile application via Wi-Fi.





Download the **Blauberg AHU** app for Android

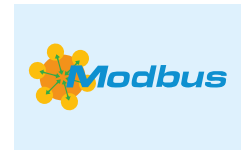

Download the **Blauberg AHU** app for iOS



Automation functions

Functions	KOMFORT ROTO EC D(2)(E) S21
Control via Wi-Fi using a mobile application	+
Control via a wired remote control panel	S22 control panel (option) 
Control via a wireless remote control panel	S22 Wi-Fi control panel (option) 
Control via a wired remote LCD control panel	S25 control panel (option) 
BMS (Building Management System)	RS-485
	Wi-Fi
	Ethernet
	MODBUS (RTU, TCP)
Blauberg Cloud Server service	+
Speed selection	+
Filter replacement indication	by filter timer
Alarm indication	full alarm description in the mobile application
Week-scheduled operation	+
Timer	+
Boost mode	+
Fireplace mode	+
Cooler connection	option
Kitchen hood connection	option
Minimum supply air temperature control	+
Humidity control	option
CO ₂ control	option
VOC control	option
PM2.5 control	option
Fire alarm sensor connection	option

Option: function is available when purchasing the appropriate accessory (see the "Accessories" section).

Designation key

Series	Unit type	Motor type	Mounting type	Modification	Heater type	Rated air flow [m ³ /h]	Service side	Control
KOMFORT	Roto: rotary heat exchanger	EC: electronically commutated motor	D: suspended mounting, horizontally directed spigots	_: standard (insulation 40 mm) 2: low-profile (insulation 20 mm)	_: no heater E: electric heater	250; 350; 650	L: left R: right	S21

Overall dimensions [mm]

Model	D	D1	B	B1	H	H1	L	L1
KOMFORT Roto EC D(E) 250 S21	160	125	643	688	308	345	1003	1100
KOMFORT Roto EC D2(E) 250 S21	160	125	618	666	225	245	1002	1097
KOMFORT Roto EC D(E) 350 S21	160	125	770	818	318	361	1270	1365
KOMFORT Roto EC D2(E) 350 S21	160	125	798	847	225	245	1362	1457
KOMFORT Roto EC D(E) 650 S21	200	125	897	932	409	422	1445	1542

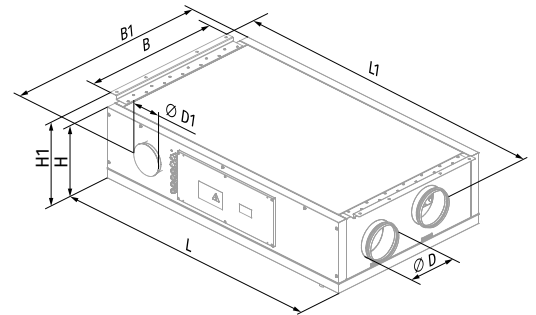

Technical data

Parameters	KOMFORT Roto EC D2 250 S21	KOMFORT Roto EC D2E 250 S21	KOMFORT Roto EC D 250 S21	KOMFORT Roto EC DE 250 S21
Voltage [V / 50 (60) Hz]	1~230	1~230	1~230	1~230
Maximum power [W]	128	828	135	835
Power of electric heater [W]	-	700	-	700
Power without heater [W]	128	128	135	135
Maximum current [A]	0.9	4.0	1.0	4.1
Current of electric heater [A]	-	3.1	-	3.1
Current without heater [A]	0.9	0.9	1.0	1.0
Maximum air flow [m ³ /h (l/s)]	300 (83)	300 (83)	310 (86)	310 (86)
RPM [min ⁻¹]	2200	2200	2200	2200
Sound pressure level at 3 m [dBA]	23	23	21	21
Transported air temperature [°C]	-25...+40	-25...+40	-25...+40	-25...+40
Casing material	galvanized steel	galvanized steel	galvanized steel	galvanized steel
Insulation	20 mm mineral wool	20 mm mineral wool	40 mm mineral wool	40 mm mineral wool
Extract filter	G4	G4	G4	G4
Supply filter	G4, F7 (option: H13)	G4, F7 (option: H13)	G4, F7 (option: H13)	G4, F7 (option: H13)
Connected air duct diameter [mm]	160	160	160	160
Weight [kg]	53	54	55	56
Heat recovery efficiency [%]*	72-87	72-87	71-87	71-87
Heat exchanger type	rotary	rotary	rotary	rotary
Heat exchanger material	aluminum	aluminum	aluminum	aluminum
SEC class	A	A	A	A
ErP	2016, 2018	2016, 2018	2016, 2018	2016, 2018

*Heat recovery efficiency is specified in compliance with EN 13141-7.

KOMFORT ROTO EC D2(E) 250

Sound power level, A-weighted	Total	Octave frequency band [Hz]								LpA 3 m	LpA 1 m
		63	125	250	500	1000	2000	4000	8000		
LWA to supply inlet [dBA]	55	18	39	42	53	50	40	30	19		
LWA to supply outlet [dBA]	72	31	46	59	68	68	60	58	46		
LWA to exhaust inlet [dBA]	50	17	34	39	49	41	34	27	17		
LWA to exhaust outlet [dBA]	65	30	41	55	64	57	52	51	40		
LWA to environment [dBA]	41	8	25	36	35	33	30	29	27	21	31

Data provided for point 1 of the air flow diagram

Total power. Total sound pressure level.

Point	Total power of the unit [W]	Sound pressure level at 3 m (1m) [dBA]
1	93	23 (33)
2	89	23 (33)
3	77	22 (32)
4	41	21 (31)
5	39	19 (29)
6	38	18 (28)
7	17	18 (28)
8	17	17 (27)
9	16	17 (27)

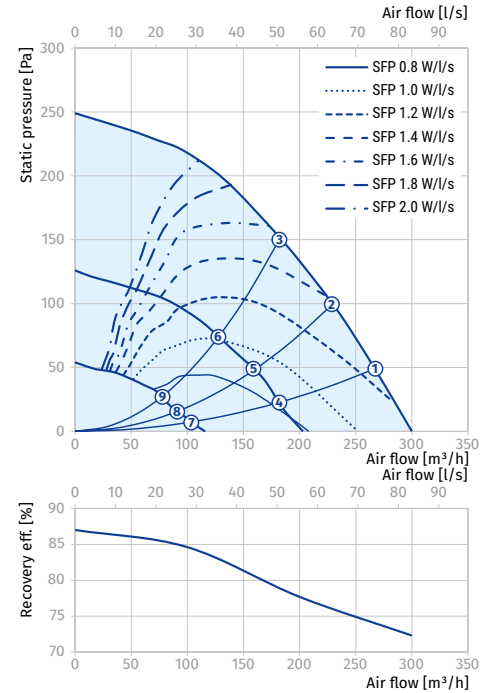

KOMFORT ROTO EC D(E) 250

Sound power level, A-weighted	Total	Octave frequency band [Hz]								LpA 3 m	LpA 1 m
		63	125	250	500	1000	2000	4000	8000		
LWA to supply inlet [dBA]	58	21	42	45	56	53	42	32	21		
LWA to supply outlet [dBA]	59	21	43	45	56	53	42	32	21		
LWA to exhaust inlet [dBA]	53	20	38	42	52	44	36	29	18		
LWA to exhaust outlet [dBA]	54	20	38	43	53	44	36	29	18		
LWA to environment [dBA]	43	10	28	39	38	35	32	31	29	23	33

Data provided for point 1 of the air flow diagram

Total power. Total sound pressure level.

Point	Total power of the unit [W]	Sound pressure level at 3 m (1m) [dBA]
1	101	21 (31)
2	115	21 (31)
3	80	20 (30)
4	45	18 (28)
5	42	17 (27)
6	40	17 (27)
7	17	16 (26)
8	17	16 (26)
9	16	16 (26)

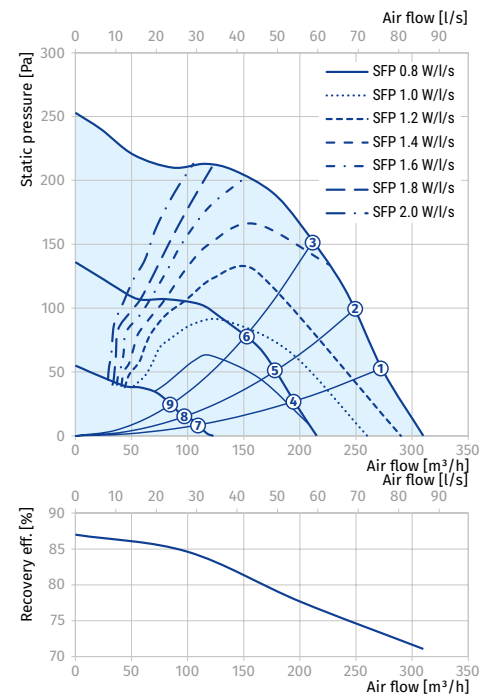

AIR HANDLING UNITS WITH ROTARY HEAT EXCHANGER

Calculation of air temperature downstream of the heat exchanger:

$$t = t_{\text{outd}} + k_{\text{hr}} \times (t_{\text{extr}} - t_{\text{outd}}) / 100,$$

where

t_{outd} – outdoor air temperature [°C]

t_{extr} – extract air temperature [°C]

k_{hr} – heat exchanger efficiency (according to the diagram) [%]

Parameters	KOMFORT Roto EC D2 350 S21	KOMFORT Roto EC D2E 350 S21	KOMFORT Roto EC D 350 S21	KOMFORT Roto EC DE 350 S21	KOMFORT Roto EC D 650 S21	KOMFORT Roto EC DE 650 S21
Voltage [V / 50 (60) Hz]	1~230	1~230	1~230	1~230	1~230	1~230
Maximum power [W]	200	1600	185	1585	367	3167
Power of electric heater [W]	-	1400	-	1400	-	2800
Power without heater [W]	200	200	185	185	367	367
Maximum current [A]	1.3	6.9	1.3	6.9	2.5	13.7
Current of electric heater [A]	-	5.6	-	5.6	-	11.2
Current without heater [A]	1.3	1.3	1.3	1.3	2.5	2.5
Maximum air flow [m³/h (l/s)]	400 (111)	400 (111)	430 (119)	430 (119)	710 (197)	710 (197)
RPM [min ⁻¹]	3200	3200	3570	3570	3600	3600
Sound pressure level at 3 m [dBA]	33	33	31	31	36	36
Transported air temperature [°C]	-25...+40	-25...+40	-25...+40	-25...+40	-25...+40	-25...+40
Casing material	galvanized steel	galvanized steel	galvanized steel	galvanized steel	galvanized steel	galvanized steel
Insulation	20 mm mineral wool	20 mm mineral wool	40 mm mineral wool	40 mm mineral wool	40 mm mineral wool	40 mm mineral wool
Extract filter	G4	G4	G4	G4	G4	G4
Supply filter	G4, F7 (option: H13)	G4, F7 (option: H13)	G4, F7 (option: H13)	G4, F7 (option: H13)	G4, F7 (option: H13)	G4, F7 (option: H13)
Connected air duct diameter [mm]	160	160	160	160	200	200
Weight [kg]	78	79	81	82	102	104
Heat recovery efficiency [%]*	73-87	73-87	72-87	72-87	80-87	80-87
Heat exchanger type	rotary	rotary	rotary	rotary	rotary	rotary
Heat exchanger material	aluminum	aluminum	aluminum	aluminum	aluminum	aluminum
SEC class	A	A	A	A	A	A
ErP	2016, 2018	2016, 2018	2016, 2018	2016, 2018	2016, 2018	2016, 2018

*Heat recovery efficiency is specified in compliance with EN 13141-7.

KOMFORT ROTO EC D2(E) 350

Sound power level, A-weighted	Total	Octave frequency band [Hz]								LpA 3 m	LpA 1 m
		63	125	250	500	1000	2000	4000	8000		
L _{WA} to supply inlet [dBA]	59	26	45	53	54	52	48	43	34		
L _{WA} to supply outlet [dBA]	83	44	58	67	75	75	79	75	71		
L _{WA} to exhaust inlet [dBA]	54	25	40	50	50	43	41	38	30		
L _{WA} to exhaust outlet [dBA]	74	42	52	63	70	63	68	66	62		
L _{WA} to environment [dBA]	53	18	35	46	49	48	43	37	33	33	43

Data provided for point 1 of the air flow diagram

Total power. Total sound pressure level.

Point	Total power of the unit [W]	Sound pressure level at 3 m (1 m) [dBA]
1	172	33 (43)
2	171	33 (43)
3	167	32 (42)
4	125	31 (41)
5	124	28 (38)
6	122	27 (37)
7	98	27 (37)
8	97	23 (33)
9	97	23 (33)

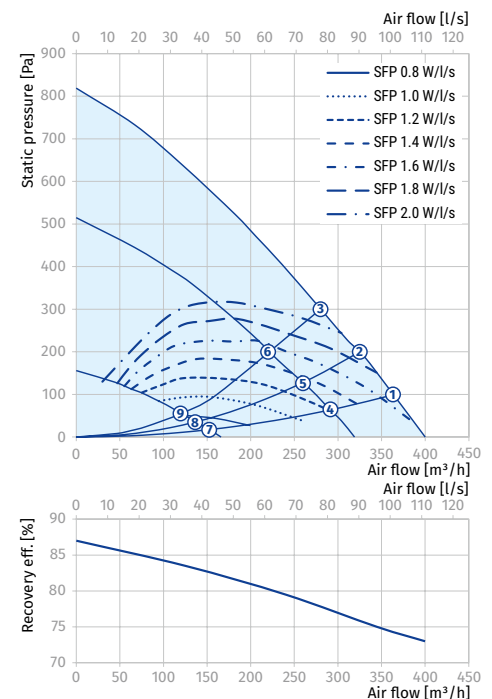

KOMFORT ROTO EC D(E) 350

Sound power level, A-weighted	Total	Octave frequency band [Hz]								LpA 3 m	LpA 1 m
		63	125	250	500	1000	2000	4000	8000		
LWA to supply inlet [dBA]	56	24	43	51	52	50	46	42	33		
LWA to supply outlet [dBA]	80	41	55	65	72	72	76	72	69		
LWA to exhaust inlet [dBA]	52	23	38	47	48	42	39	37	29		
LWA to exhaust outlet [dBA]	72	40	50	61	67	61	65	64	60		
LWA to environment [dBA]	51	16	33	44	47	46	41	36	32	31	41

Data provided for point 1 of the air flow diagram

Total power. Total sound pressure level.

Point	Total power of the unit [W]	Sound pressure level at 3 m (1m) [dBA]
1	154	31 (41)
2	151	31 (41)
3	149	30 (40)
4	116	27 (37)
5	116	26 (36)
6	115	26 (36)
7	76	24 (34)
8	75	21 (31)
9	63	21 (31)

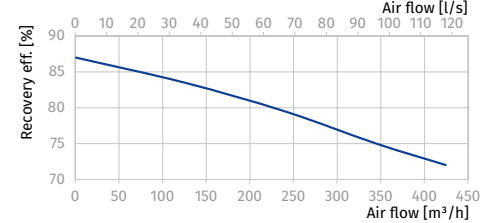
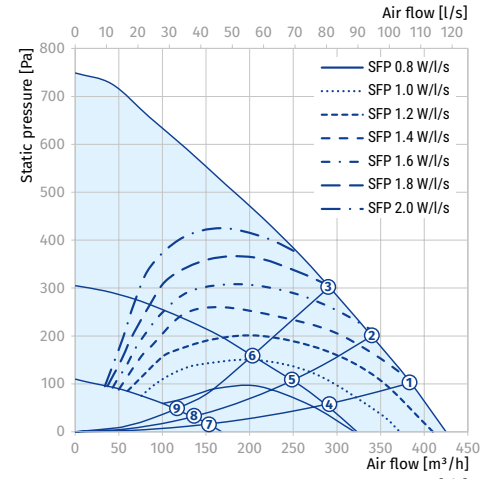

KOMFORT ROTO EC D(E) 650

Sound power level, A-weighted	Total	Octave frequency band [Hz]								LpA 3 m	LpA 1 m
		63	125	250	500	1000	2000	4000	8000		
LWA to supply inlet [dBA]	79	56	62	64	74	72	74	71	66		
LWA to supply outlet [dBA]	68	48	51	57	67	52	49	42	30		
LWA to exhaust inlet [dBA]	81	55	60	64	77	73	75	71	66		
LWA to exhaust outlet [dBA]	67	47	51	58	65	58	57	48	39		
LWA to environment [dBA]	57	30	46	45	55	46	47	39	38	36	46







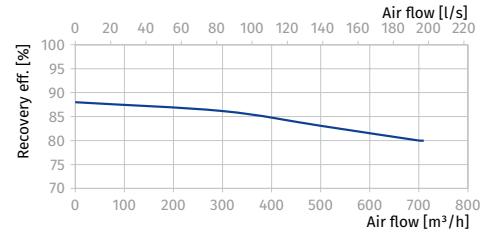
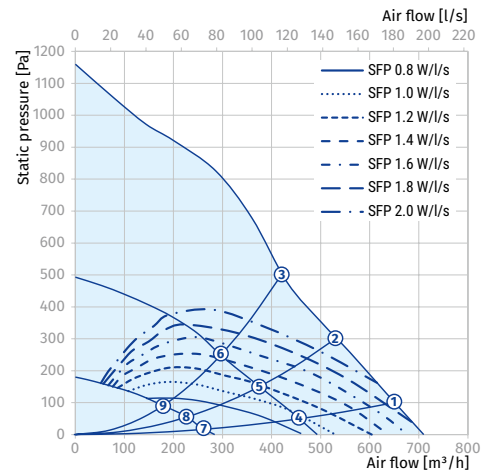









Data provided for point 1 of the air flow diagram

















Total power. Total sound pressure level.

Point	Total power of the unit [W]	Sound pressure level at 3 m (1m) [dBA]
1	342	36 (46)
2	342	36 (46)
3	342	35 (45)
4	122	31 (41)
5	122	29 (39)
6	122	29 (39)
7	34	27 (37)
8	33	24 (34)
9	33	24 (34)



Accessories

		KOMFORT Roto EC D2(E) 250 S21	KOMFORT Roto EC D(E) 250 S21	KOMFORT Roto EC D2(E) 350 S21
G4 panel filter		FP 280x180x48 G4	FP 260x220x48 G4	FP 372x180x48 G4
F7 panel filter		FP 280x180x48 F7	FP 260x220x48 F7	FP 372x180x48 F7
H13 panel filter		FP 280x180x48 H13	FP 260x220x48 H13	FP 372x180x48 H13
Control panel		S22	S22	S22
Wireless control panel		S22 Wi-Fi	S22 Wi-Fi	S22 Wi-Fi
LCD control panel		S25	S25	S25
VOC sensor		DPWQ30600	DPWQ30600	DPWQ30600
External CO ₂ sensor		DPWQ40200	DPWQ40200	DPWQ40200
Humidity sensor		DPWC11200	DPWC11200	DPWC11200
Humidity sensor		HR-S	HR-S	HR-S
Humidity sensor		FS2	FS2	FS2
Kitchen hood		DAH 251-13	DAH 251-13	DAH 251-13
Backdraft air damper		VRV 160	VRV 160	VRV 160
Air damper		VKA 160	VKA 160	VKA 160
Electric actuator		LF230	LF230	LF230
Electric actuator		TF230	TF230	TF230

		KOMFORT Roto EC D(E) 350 S21	KOMFORT Roto EC D(E) 650 S21
G4 panel filter		FP 320x235x48 G4	FP 378x295x48 G4
F7 panel filter		FP 320x235x48 F7	FP 378x295x48 F7
H13 panel filter		FP 320x235x48 H13	FP 378x295x48 H13
Control panel		S22	S22
Wireless control panel		S22 Wi-Fi	S22 Wi-Fi
LCD control panel		S25	S25
VOC sensor		DPWQ30600	DPWQ30600
External CO ₂ sensor		DPWQ40200	DPWQ40200
Humidity sensor		DPWC11200	DPWC11200
Humidity sensor		HR-S	HR-S
Humidity sensor		FS2	FS2
Kitchen hood		DAH 251-13	DAH 251-13
Backdraft air damper		VRV 160	VRV 200
Air damper		VKA 160	VKA 200
Electric actuator		LF230	LF230
Electric actuator		TF230	TF230