



Air conditioner

User & installation manual

Wi-Fi Kit 2.0 MIM-H04EN / MIM-H04N / MIM-H04NDZ

- Thank you for purchasing this Samsung Product.
- Before operating this unit, please read this manual carefully and retain it for future reference.



SAMSUNG





Contents

Safety precautions	3
Checks before Installation	5
Accessories	5
External Dimensions	5
Installing the Wi-Fi Kit	6
Wi-Fi Kit installation	6
Setting the indoor unit tenants for each user	12
Checking the Wi-Fi Kit	15
Initializing the user data	16
Updating with a Micro SD card	16
SmartThings app	17
Checking the power connections	17
Setting up and connecting to a Wi-Fi access point using your smartphone	17
Downloading the SmartThings app and registering your Samsung account	18
Connecting the SmartThings app to your product	18
Starting the system air conditioner app	20
Controlling the air conditioner	20
Troubleshooting	21
Specifications	23
Open Source Announcement	23
Declaration of Conformity	24
Caution about 5GHz range radio equipment	26



Correct Disposal of This Product (Waste Electrical & Electronic Equipment)

(Applicable in countries with separate collection systems)

This marking on the product, accessories or literature indicates that the product and its electronic accessories (e.g. charger, headset, USB cable) should not be disposed of with other household waste at the end of their working life. To prevent possible harm to the environment or human health from uncontrolled waste disposal, please separate these items from other types of waste and recycle them responsibly to promote the sustainable reuse of material resources.

Household users should contact either the retailer where they purchased this product, or their local government office, for details of where and how they can take these items for environmentally safe recycling.

Business users should contact their supplier and check the terms and conditions of the purchase contract. This product and its electronic accessories should not be mixed with other commercial wastes for disposal.

The lowest set temperature is limited to 20 degree in the UAE according to UAE.S 5010-5:2016.

เครื่องโทรคมนาคมและอุปกรณ์นี้มีความสอดคล้องตามมาตรฐานหรือข้อกำหนดทางเทคนิคของ กสทช.







Safety precautions

This installation manual explains how to install a Wi-Fi Kit to an indoor unit of Samsung system air conditioners.

Read the installation manual thoroughly before installing the Wi-Fi Kit.

(Refer to the appropriate manual for installing product or other optional parts.)

 WARNING	Hazards or unsafe practices that may result in severe personal injury or death.
 CAUTION	Hazards or unsafe practices that may result in minor personal injury or property damage.

WARNING

- Contact service center for installation.
 - There is a risk of product malfunction, water leakage, electric shock or fire.
- Install the Wi-Fi Kit securely in a place that can withstand the weight of the product.
 - If the installation location is not strong enough, Wi-Fi Kit may fall and be damaged.
- Connect the power with rated voltage when installing.
 - If not, there is risk of fire or damage to the Wi-Fi Kit.
- Do not attempt to move or re-install the Wi-Fi Kit that is already installed.
 - There is risk of electric shock and fire.
- Do not attempt to modify or repair the Wi-Fi Kit on your own.
 - There is potential risk of product damage, electric shock or fire. When repair is needed, consult service center.
- Check if the installation was done properly according to the installation manual.
 - If the Wi-Fi Kit is installed incorrectly, there is risk of electric shock or fire.
- Make sure that all wiring work is done by a qualified person complying with regional standards and instructions in this manual.
 - If the installation is done by unqualified person, there is risk of product malfunction, electric shock or fire caused by incorrect installation.
- Contact the service center if you need to dispose the Wi-Fi Kit.



Safety precautions

CAUTION







- Do not install the product in a place where it is or might be exposed to inflammable gas leakage.
 - There is risk of fire or explosion.
- Do not install the product in a place where it will be exposed to oil or vapor etc.
 - If the product is used in a place where it is exposed to oil, vapor or sulphur dioxide, parts of the product may get damaged or product may function abnormally.
- Make sure that water does not get into the Wi-Fi Kit.
 - There is risk of electric shock and fire.
- Make sure there is no tension to the cable during installation.
 - Cable may get cut and cause fire.
- Install the product in a place with temperature between 0 °C~39 °C with no direct sunlight.
 - If not, there is risk of electric shock or abnormal operation.
- Do not install the product in a place where special spray or acid/alkali solution is used.
 - There is risk of electric shock or abnormal operation.
- Do not press the buttons with sharp objects.
 - There is risk of electric shock or damaging the parts.
- Do not connect the power cable to the communication cable terminal.
 - There is risk of fire.
- When installing the product in hospitals or other places, make sure that the product does not interrupt with other products.
 - Abnormal operation may occur.
- This wireless device has a possibility of radio wave interference during operation.



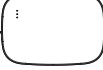

Checks before Installation

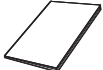
Accessories

Wi-Fi Kit	Cable ties (2)	Cable clamps (3)	M4×16 screws (5)
			
User & installation manual	U-type terminals (6)		
			



- The Wi-Fi Kit must be installed by a certified technician.
- Before installation, be sure to cut off power.
- Follow applicable rules for electrical wiring. Make sure that the cables of the Wi-Fi Kit are installed inside a wall or covered to avoid being touched by the occupant.

External Dimensions

Unit: mm

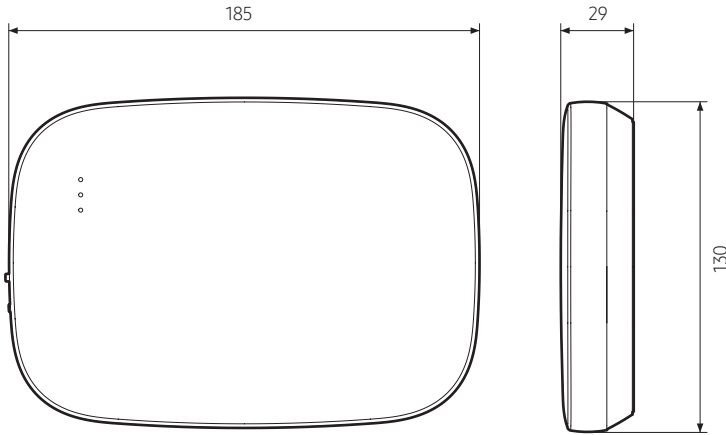

Installing the Wi-Fi Kit

Wi-Fi Kit installation



- To ensure smooth operation, there should be no obstacle between the Wi-Fi Kit and wireless router that may interfere with communication. When the Wi-Fi Kit is too far from a router or there are potentially interfering elements between them, it may cause problems with the performance of the Wi-Fi Kit that cannot be resolved by customer services.
- Place the Wi-Fi Kit in an area where you can easily press the AP button for device verification.
- Do not install the Wi-Fi Kit in an area where it may be exposed to moisture or impact.
- Operating temperature: 0-40 °C, Operating humidity: 30-90 % (relative)

1. Use a flathead screwdriver to turn each of the square holes at the lower part of the Wi-Fi Kit and remove the back cover.

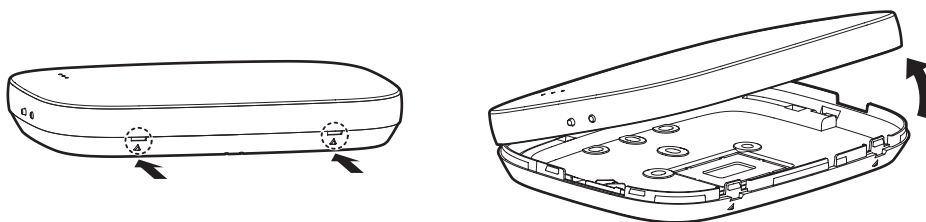

- ※ Push both latches at the same time.



- Use a flathead screwdriver to turn the rectangular hole at the upper part of the fixing hook for easy removal.

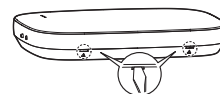

2. Arrange the power and communication cables along the back cover.

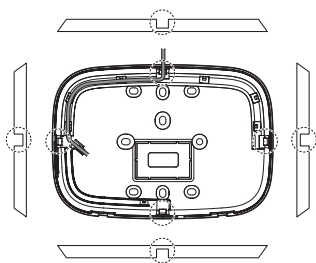

<Wires installed on the wall>

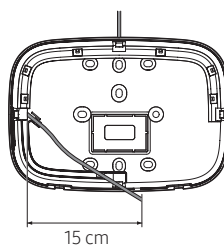

15 cm

If necessary, remove this part to secure more space for wiring.

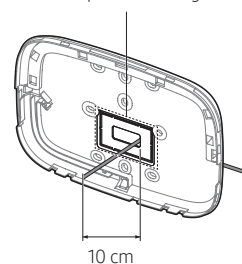

10 cm

<Wires installed in the wall>



- Use two or more screws to fix the back cover to the wall. Connect the power cables (V1, V2) and communication cables (F1, F2) to the terminals on the back of the front cover while adjusting to a suitable length.
- When connecting the power cables to V1 and V2, fasten the PCB terminal screws (CN5) to a torque of 6 N·cm or less.

Screw size: M3 x 6



- You can connect up to 16 indoor units to a Wi-Fi Kit.

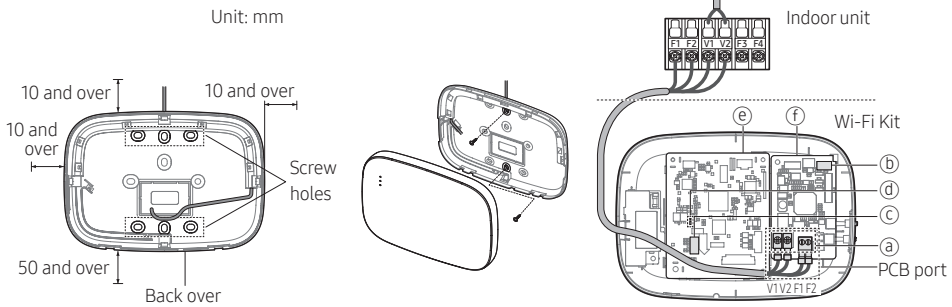

※ Be sure to secure space of at least 10 mm (up/right/left) and 50 mm (down) around the back cover before fixing the back cover on the wall.

※ Fix the screws to the screw holes.

※ Do not over-tighten the PCB terminal.

Item	Contents	Item	Contents
(a)	Power/communication terminals	(d)	LED
(b)	Tracking/Reset button	(e)	Network PBA
(c)	Micro SD card slot	(f)	Interface module PBA

- Assemble the Wi-Fi Kit again.



- Insert the front cover to the upper grooves as shown in the figure. After assembly, make sure that there is no gap between the covers.

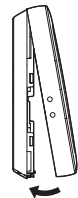



Installing the Wi-Fi Kit

Wi-Fi Kit wiring diagram

1) Connecting to a single outdoor unit (F1-F2)

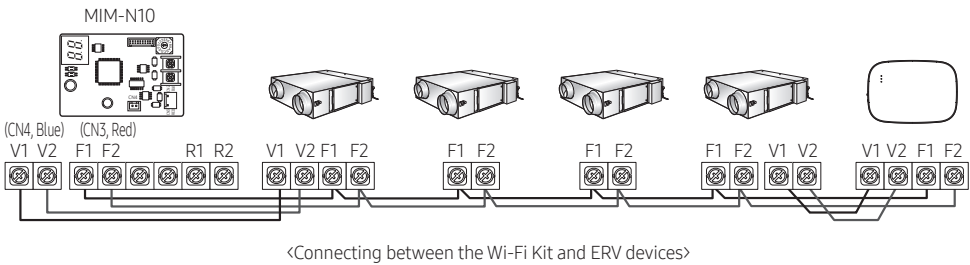
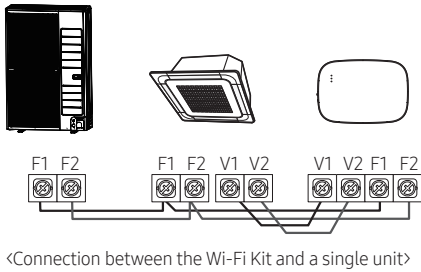
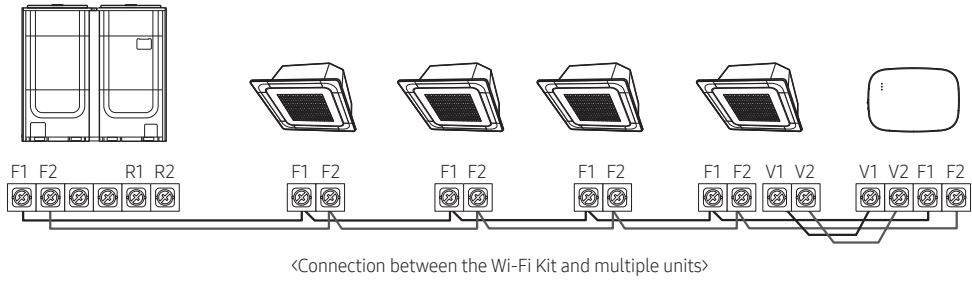



2) Connecting to multiple outdoor units (R1-R2)

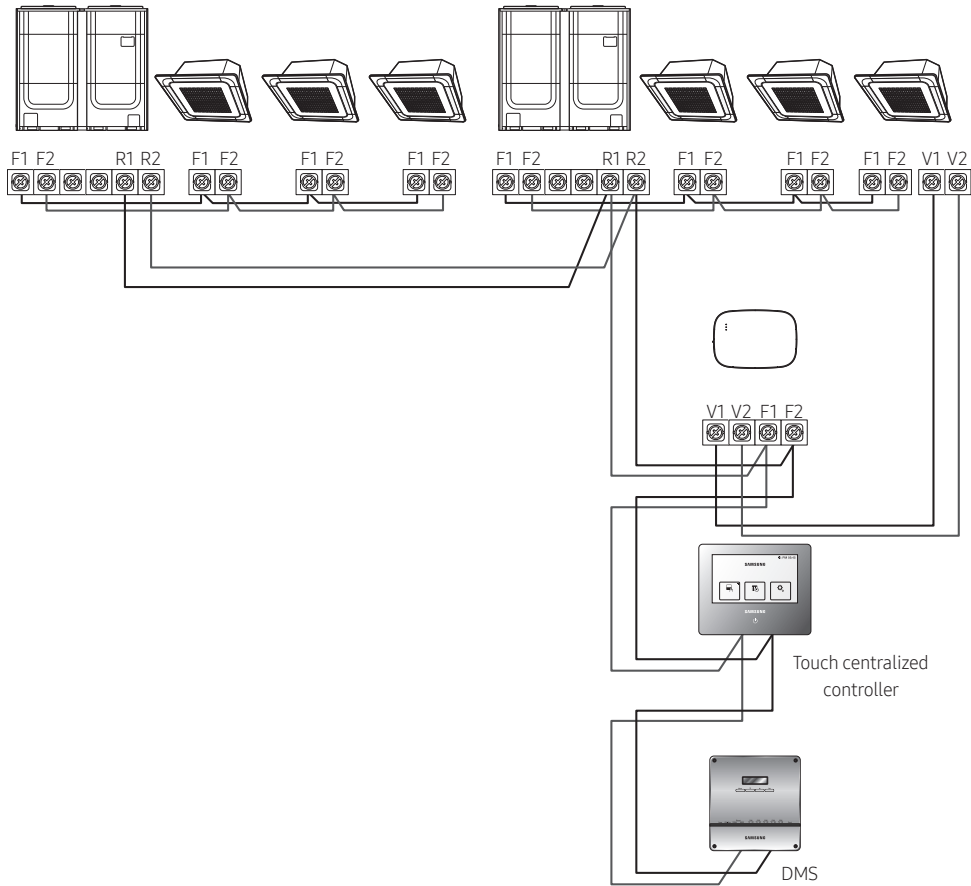

- You can connect up to 16 indoor and outdoor units.





Installing the Wi-Fi Kit

3) Connecting the Wi-Fi Kit and the ERV together (R1-R2)

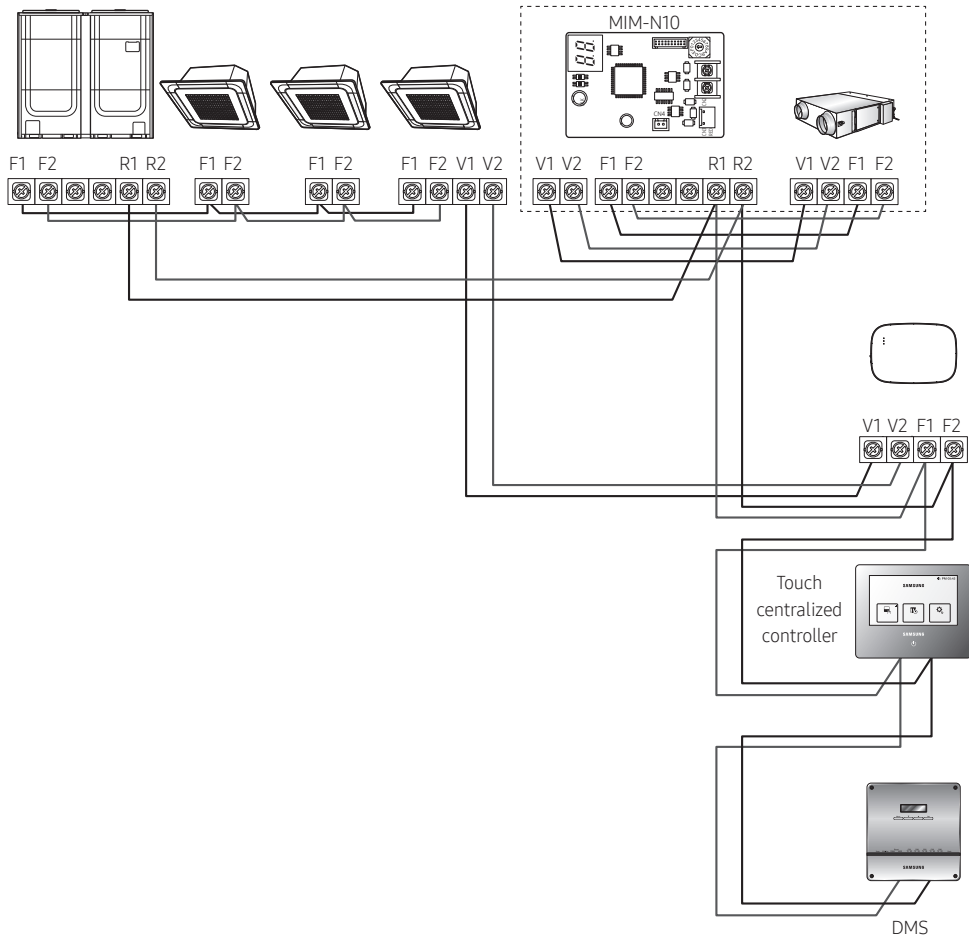

- Connect R1 and R2 on the outdoor unit to F1 and F2 of the Wi-Fi Kit.
- Connect the power cable to V1 and V2 of the indoor unit or ERV.
- Other controllers (e.g. touch centralized controller, DMS) can be installed together.





- ※ For indoor units without V1 and V2 connection terminals, use the external control line 2 for SUB PBA (inside the indoor unit) for 12VDC power supply.

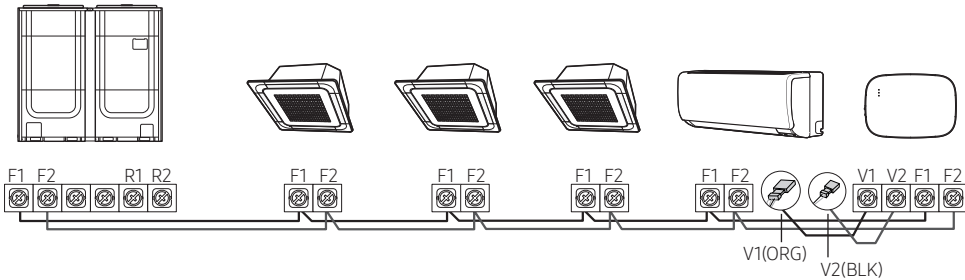
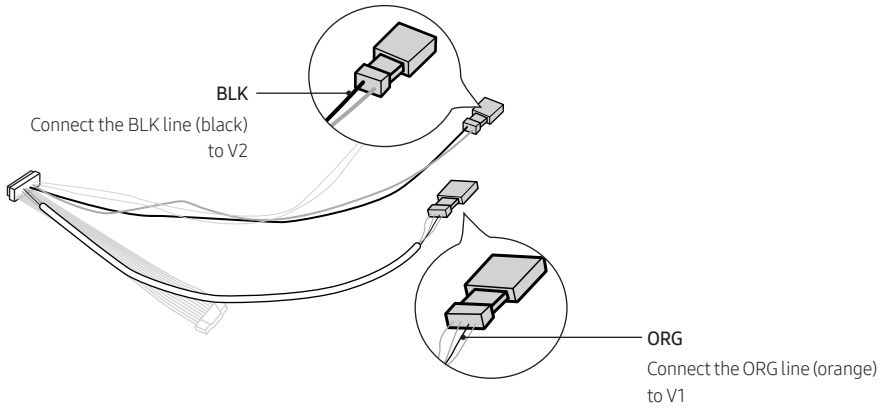

- When installing the Wi-Fi Kit, use proper electrical cables considering the size of the wiring hole on the wall.
- Upon wiring, use the provided U-type terminals (#16-22). When there are no terminals provided or #24 is used, you can use any U-type terminals that meet the specifications.
- Wi-Fi Kit communication and power cables
 - When installing the Wi-Fi Kit, follow the wiring specifications for the U-type terminal.
 - When installing the Wi-Fi Kit with a 4-wire PVC cable, first peel off the PVC edge (approx. 30 cm). (AWG22 recommended)
- U-type terminal specifications for the Wi-Fi Kit PCB

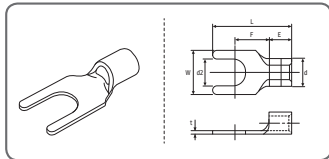

Cable range		Rated size	Stud size	Default size (mm)					
AWG	mm ²	mm ²	mm	t	d	E	F	W	L
24 - 16	0.25 - 1.65	1.5	3 - 3.2	0.6 - 0.8	1.2 - 2.5	4 - 6	5 - 9	5 - 7	12 - 21.2

Max. length for communication/power cables: 50 m

- Fasten the PCB terminal with fixing screws to a torque of 6 N•cm or less. When you fasten the screw to a torque over 6 N•cm, it may cause damage to the screw thread.



Installing the Wi-Fi Kit

6. Activate the Wi-Fi Kit.
 - When power is supplied, all indicators on the Wi-Fi Kit illuminate until the system boots completely.
 - After the system operates, tracking is performed automatically.
7. Tracking
 - ※ Tracking: The Wi-Fi Kit detects connected indoor unit(s) and the indoor unit(s) detects the connection to the Wi-Fi Kit. Tracking is required to monitor or control the system air conditioner using the Wi-Fi Kit.
 - The Wi-Fi Kit automatically performs tracking when activated. The () () indicators on the Wi-Fi Kit blink while in tracking.
 - When no indoor unit is detected by tracking, the () indicator blinks for 10 seconds and the Wi-Fi Kit attempts tracking again. In this case, make sure that the communication cables between the indoor and outdoor units are connected properly.
 - When any change in the installation of indoor and outdoor units occurs, manually run the tracking by pressing the (SW3, ) button inside the Wi-Fi Kit.

CAUTION  • When tracking is completed but all the connected indoor units have the central control option disabled, the () indicator illuminates for 10 seconds and the () indicator blinks. Then the Wi-Fi Kit attempts the tracking again. In this case, check and change the central control option for indoor units. When the central control option is disabled, you cannot control indoor units via the Wi-Fi Kit.

NOTE  • To control indoor units by using a mobile phone, wait until the tracking is completed and then connect the Wi-Fi Kit to a wireless router.
 • The () indicator does not turn off until the Wi-Fi Kit is connected to a wireless router after tracking.

Setting the indoor unit tenants for each user

NOTE  • The multi-tenants feature allows you to control and monitor the indoor units with the group channel address (RMC1) that is the same as that of the Wi-Fi Kit.

In order to selectively use the indoor units connected to a single outdoor unit by multiple users, you can install multiple Wi-Fi Kits and group the indoor units by setting the group channel address (RMC1) for each Wi-Fi Kit.

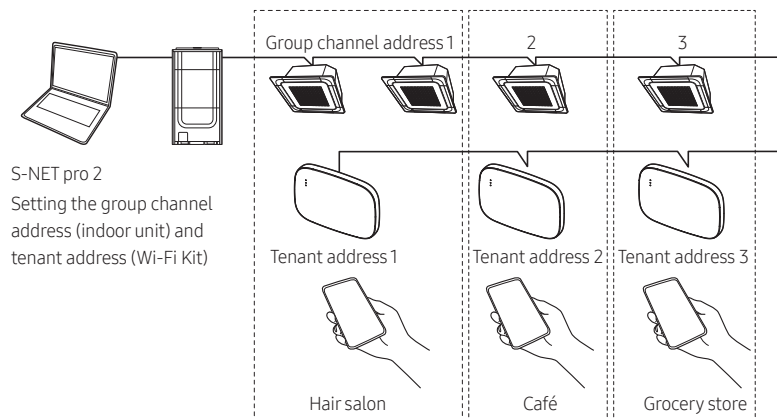

Installing the Wi-Fi Kit

- 1) Press the [Search] button to find the connected Wi-Fi Kits.
- 2) One by one, select the MAC address for each Wi-Fi Kit from the list.
 - You can see the MAC address on the label inside the Wi-Fi Kit.

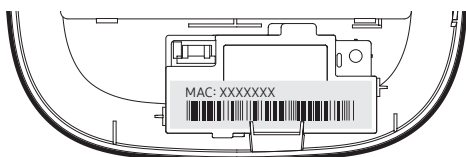

- 3) Set the tenant address. (Unavailable, 0-F)
 - Seeing the table below, enter the tenant address on the S-NET pro 2.

Tenant address	Group channel address for the indoor units controlled by a Wi-Fi Kit
Unavailable	Controls all indoor units connected to the outdoor unit
0	Controls the indoor units with the group channel address "0"
1	Controls the indoor units with the group channel address "1"
2	Controls the indoor units with the group channel address "2"
3	Controls the indoor units with the group channel address "3"
4	Controls the indoor units with the group channel address "4"
5	Controls the indoor units with the group channel address "5"
6	Controls the indoor units with the group channel address "6"
7	Controls the indoor units with the group channel address "7"
8	Controls the indoor units with the group channel address "8"
9	Controls the indoor units with the group channel address "9"
A	Controls the indoor units with the group channel address "A"
B	Controls the indoor units with the group channel address "B"
C	Controls the indoor units with the group channel address "C"
D	Controls the indoor units with the group channel address "D"
E	Controls the indoor units with the group channel address "E"
F	Controls the indoor units with the group channel address "F"

- e.g. When you set the tenant address of a Wi-Fi Kit to 2 through the S-NET pro 2, the Wi-Fi Kit can control and monitor the indoor units with the RMC1 set as 2.
- 4) Select the [Apply] button to save the specified tenant address for the Wi-Fi Kit.



NOTE

- To set the group channel address for indoor units, see "Setting the indoor unit address" in Installation Manual of the indoor unit. [SEG9: 1 (for RMC address mode), SEG11: RMC1 address setting]
- To set the tenant address upon request, contact the Samsung service centre.
- To control all indoor units with different tenant addresses, make sure that all the Wi-Fi Kits are registered to the smartphone.
- When using the multi-tenants feature for Wi-Fi Kits, the upper-level controllers (touch centralized controller, DMS) other than the OnOff controller can be installed at the same time.



Checking the Wi-Fi Kit

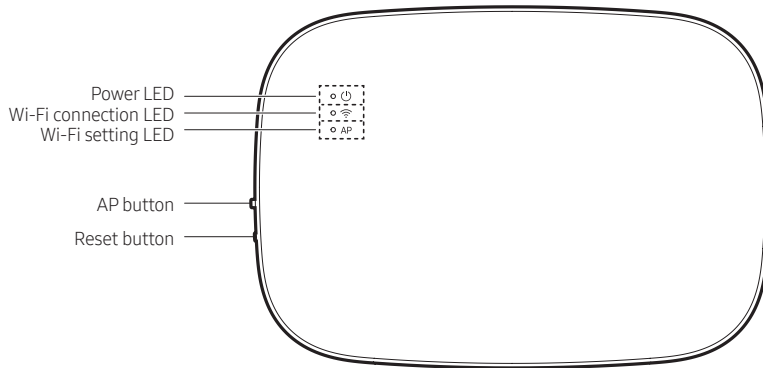

<Front panel of the Wi-Fi Kit>

Items on the LED display

Item	LED indication	Power supply	Wi-Fi connection	Wi-Fi setting
1	Initialized	On	On	On
2	General	On	On	Off
3	AP connected, Internet connection incomplete	On	Blinking	Off
4	Tracking completed, AP connection incomplete	On	Off	Off
5	Wi-Fi modem malfunctioning	Blinking	Blinking	Blinking
6	Searching AP (AP mode)	On	Off	On
7	Tracking units	Blinking	Blinking	Off
8	No unit tracked	Blinking	Off	Off
9	Inspection of the network PBA required	On	Blinking	Blinking
10	User authentication required (AP mode)	On	Off	Blinking
11	Downloading	Off	On	Off
12	Rescue mode	Blinking	On	Blinking

* If the "Rescue mode" indication appears on the LED:

- Reset the Wi-Fi Kit using the "Reset" button, and check if "Rescue mode" turns off.
- If "Rescue mode" persists even though you tried resetting the Wi-Fi kit several times, contact a service center.





Installing the Wi-Fi Kit

Initializing the user data

- To initialize the user data on a Wi-Fi Kit, press the (SW3) button inside the Wi-Fi Kit for 5 seconds. All the indicators illuminate and the user data is deleted.

Updating with a Micro SD card

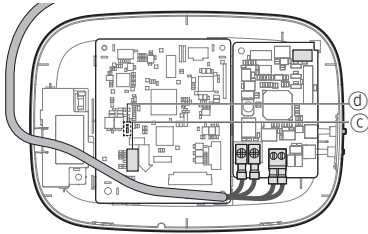

Type	Capacity	File system
Micro SD	Max 4GB	FAT16
Micro SDHC	Max 32GB	FAT32

1. Create a folder named "update" in the Micro SD card. Copy the latest software image and paste it into the folder created in the Micro SD card.



- Be sure to format the Micro SD card using FAT16 or FAT32 before creating the "update" folder.

2. Insert the Micro SD card into the slot of the Wi-Fi Kit.
3. Press the [Reset] button on the side of the Wi-Fi Kit.
4. The indicator (D) on the Wi-Fi Kit blinks every 2 seconds during update.
 - Once the update has been successful, the indicator promptly turns on and then turns off longer. (On: 0.2 second, Off: 2 seconds)
 - The indicator blinks every 0.2 second when the update was not completed.
5. When the update has completed normally, remove the Micro SD card and then press the [Reset] button.
6. Restarting the Wi-Fi Kit after an update failure will restore the software to the previous version. When the update failure persists, follow the instructions below:
 - File checking: Change the update image (file).
 - Micro SD card checking: Replace the Micro SD card.
 - PBA checking: Replace the network PBA.





SmartThings app

To use the SmartThings app, connect the product to the network in the sequence described below. The images shown may differ depending on your smartphone model, OS version and manufacturer. You need to set up the Wi-Fi access point only when connecting the product to a Wi-Fi network. Once the product is connected, you can use the SmartThings app via Wi-Fi, 3G, LTE or more wireless networks.

Checking the power connections

Check if the power is connected to the product and the access point.

Setting up and connecting to a Wi-Fi access point using your smartphone

- To connect the product to a Wi-Fi network, turn on Wi-Fi at "Settings > Wi-Fi", and then select the access point to connect to
 - Only alphanumeric characters are supported for wireless access point names (SSIDs). If an SSID has a special character, rename it before connecting to it.

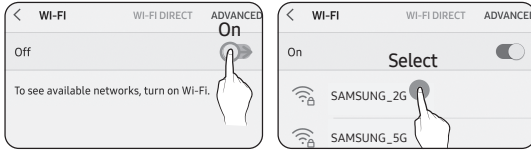

- Turning off "SMART NETWORK SWITCH" at "Settings > Wi-Fi" on your Smartphone
 - If "SMART NETWORK SWITCH" or "Adaptive Wi-Fi" is turned on, you cannot connect to the network. Be sure to turn off these functions before connecting to the network.

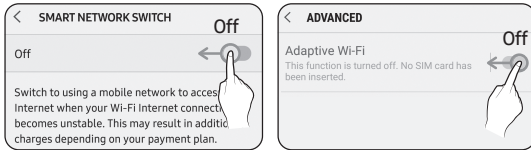

- The setup may differ depending on your smartphone model, OS version and manufacturer.

3. Checking the Internet connectivity

- After connecting to Wi-Fi, check that your smartphone is connected to the Internet.



- A firewall may prevent your smartphone from connecting to the Internet. In this case, contact your Internet service provider for troubleshooting.





SmartThings app

Downloading the SmartThings app and registering your Samsung account

1. Downloading the SmartThings app



- Search for "SmartThings" on Play Store or App Store, and download the SmartThings app to your smartphone.
- If the SmartThings app is already installed on your smartphone, update it to the latest version.



NOTE

- For the tablets that are not supported by the SmartThings app and the smart phones that has an OS version earlier than the recommended versions, the SmartThings app may not be found.
 - Android OS 6.0 or later (with at least 2 GB RAM) is recommended.
 - Supported screen resolutions: 1280 x 720 (HD), 1920 x 1080 (FHD), 2560 x 1440 (WQHD)
- The SmartThings app is not compatible with some Apple devices including iPad and some smartphones.
 - iPhone 6 or later with iOS 10.0 or later is supported.
 - Supported screen resolutions: 1334x750, 1920x1080
- The SmartThings app may change without prior notice to improve product usability and performance.

2. Registering your Samsung account

- A Samsung account is required to use the SmartThings app. To create your Samsung account and log in to your account, follow the instructions displayed on the SmartThings app. You do not need to install an additional app.



NOTE

- If you already have a Samsung account, log in to the account. When your smartphone is a Samsung device and you have a Samsung account, your smartphone is automatically logged in to your account.
- If you log in from a smartphone produced for a different country, you need to log in with its country code when you create your Samsung account, and the SmartThings app may not be used on some smartphones.

Connecting the SmartThings app to your product

1. Selecting the product to connect to

- 1) After the Wi-Fi kit tracking is complete, run the SmartThings app.
- 2) After the SmartThings app is started, select "ADD NOW" when a pop-up window saying that a product to connect to is found appears.

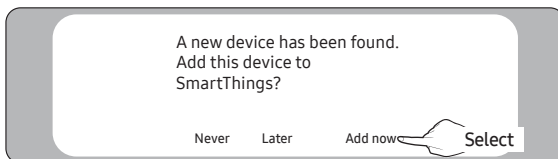



3) If the pop-up window does not appear, select "+", and then "Add Devices".

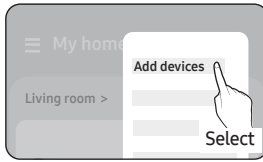
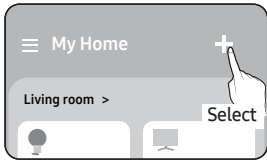

You can add a product you want to connect to by selecting it manually or by selecting "Auto detect".

- Select manually: Samsung > Air conditioner > System air conditioner
- Auto detect: [System a/c] Samsung

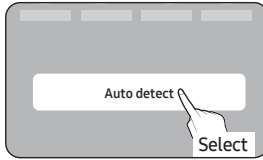
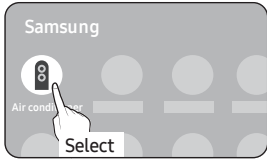

2. Connecting the SmartThings app to your product

- Follow the instructions displayed on the SmartThings app to connect to your product.
- For information on how to use the SmartThings app, select the How To menu on the app.



NOTE

- If any pop-window appears on the top of the smartphone while connecting to your product, do not select it.
- If a pop-up window saying that the device is already registered appears during connecting to your product, get permission using "REQUEST PERMISSION" from a user already connected to the product, or create a new account using "REGISTER MY ACCOUNT" to independently connect to the product.
- If a Samsung account-related country error occurs during connecting to your product, log out of your current Samsung account, log in to your previous Samsung account, and then delete all devices that have been connected previously. Then, log in to your current Samsung account again, and then configure the settings.
- If a failure message appears while adding a device, see "Setting up and connecting to a Wi-Fi access point using your smartphone" on page 17. The connection may fail temporarily due to an installation location problem of the access point or other problems.
- If the number of added indoor units is incorrect after adding devices, run the tracking again and then try adding the devices again.
- For security protocols for wireless/wired access points, WPA-PSK and WPA2-PSK are recommended. For authentication methods, AES is recommended. New Wi-Fi authentication specifications and Wi-Fi non-standard authentication methods are not supported.
- If your Internet service provider permanently have registered the MAC address (a unique identification number) of your PC or modem, you may not be able to connect your product to the Internet. Contact your Internet service provider and ask how to connect devices other than your PC (such as an air conditioner and an air purifier) to the Internet.



Starting the system air conditioner app

Controlling the air conditioner

Below are functions that you can control or monitor using the Wi-Fi adapter.

Category	Function	Description
Monitoring	Desired Temp	Displays the desired temperature.
	Current Temp	Displays the current temperature.
	Filter warning	An alert is generated after the filter time elapses.
	Defrost	Appears in the defrost state.
Control	Power supply	Turn on or off the air conditioner.
	Operation mode	Select the desired operation mode.
	Temperature control	Adjust the desired temperature.
	Fan speed	Adjust the desired fan speed.
	Air flow direction	Adjust the desired air flow direction.
	Wind-Free	Enables/disables the Wind-Free function.
	Long	Enables/disables the Long function.
	Clean	Enables/disables the Clean function.
	Motion detection	Enables/disables the motion detection function.
	Direct/indirect wind	Select any of direct wind and indirect wind while in motion detection.
	Ionizer	Enables/disables the Ionizer function.
	Energy monitor	Displays the power usage on the daily/weekly/monthly basis.
	Reset Filter	Upon a filter alert, you can initialize the filter reset time.
	Ventilation	Enables/disables the Ventilation.
Hot water	Enables/disables the Hot water function.	



NOTE



- Available features may differ depending on the model.
- Some features may not be available according to the specifications of the indoor unit.
- For more information about the SmartThings app, details can be found in SmartThings app.

Troubleshooting

Check the following before requesting a service from the Service Centre.

Symptom		Measure
The installed SmartThings app cannot access the air conditioner.		<ul style="list-style-type: none"> Make sure you have connected the air conditioner to a wireless router.
I cannot log in with my Samsung account.		<ul style="list-style-type: none"> Try recovering your ID and password from the Samsung account page.
Adding device(s)	A failure message appears while adding devices.	<ul style="list-style-type: none"> This may fail temporarily due to the distance from the router or some interferences. Try again later.
	I found a failure message in 0 to 1 percent of device addition process.	<ul style="list-style-type: none"> You can add device units only in AP search state. Check that both the power LED and Wi-Fi setup LED are turned on. Otherwise, press and hold the AP button for over 5 seconds to activate the AP search. You cannot add any device without deleting it once the device has already been added to the SmartThings app. To add the connected device again, first remove it and then proceed with the process.
	I found a failure message in 99 percent of device addition process.	<ul style="list-style-type: none"> If you are using a Samsung smartphone, the server may not be connected temporarily. Turn off and on the power of the Wi-Fi Kit, launch the SmartThings app again, and then try adding a device again. If your phone is not a Samsung product, check that you have entered a wrong Wi-Fi password. Try adding devices again.
	The app displays an authorization failure before pressing the user agreement button.	<ul style="list-style-type: none"> Check whether there are any Wi-Fi Kits already added to the SmartThings app. When there are devices added, first remove them and try again.
	The app displays an authorization failure on the user agreement screen.	<ul style="list-style-type: none"> You must press the AP button within 1 minute. Try adding devices again.
	The screen requests to initialize the user account.	<ul style="list-style-type: none"> This happens when the user has already added devices. Follow the instructions provided in the SmartThings app.
The power LED and Wi-Fi connection LED are blinking.		<ul style="list-style-type: none"> The communication between the Wi-Fi Kit and indoor/outdoor units is unstable. Check the communication cables for indoor and outdoor units or check the central control option for indoor units.
After adding a device, the SmartThings app displays the disconnection event.		<ul style="list-style-type: none"> This happens when a device is being added to the server or it is temporarily disconnected from the router. End the SmartThings app and then launch it again.

Troubleshooting

Symptom		Measure
The controls of the SmartThings app do not operate.	Are all three LED indicators on the Wi-Fi Kit turned on?	<ul style="list-style-type: none"> Reset the Wi-Fi Kit and then check it again.
	Does only  appear on the display of the Wi-Fi Kit?	<ul style="list-style-type: none"> Make sure you have entered the correct Wi-Fi password when adding a device. Check the router status.
	Is the  indicator blinking?	<ul style="list-style-type: none"> Check that the wireless router is connected to the Internet.
	Are all LED indicators on the Wi-Fi Kit blinking?	<ul style="list-style-type: none"> This indicates a Wi-Fi Kit malfunction. Contact the Samsung service centre.
	Is the  indicator blinking?	<ul style="list-style-type: none"> The Wi-Fi Kit is not connected to the indoor unit(s) normally. Contact the Samsung service centre.
The SmartThings app displays the error number, 628.		<ul style="list-style-type: none"> This indicates a communication error between the indoor unit(s) and Wi-Fi Kit. Check the connection of the communication cables (F1, F2).
I have a multi-unit HVAC system, but I can only see either cooling or heating option on the indoor unit.		<ul style="list-style-type: none"> To avoid mixed control, the indoor unit options are automatically restricted to the outdoor unit's settings. <p>※ Mixed control: Different modes are available for each indoor unit.</p> <ol style="list-style-type: none"> To select a mode other than the current operation mode, turn off the indoor unit to display all operation modes to select. When there is a master indoor unit, change the operation mode of the master unit.
The LED indicator remains in its initial state. (The LED state changes within 1 minute.)		<ol style="list-style-type: none"> Check the connection cable between the network PBA and the Interface module PBA. Even though the connection has no problem but a problem persists, replace the Wi-Fi Kit.

Specifications

MIM-H04EN

Wi-Fi	
Frequency Range	Transmitter Power (Max)
2412 - 2472 MHZ	17 dBm
5120 - 5250 MHZ	16 dBm
5250 - 5350 MHZ	16 dBm
5470 - 5725 MHZ	16 dBm

*** European Class A Warning :**

This is a class A product. In a domestic environment this product may cause radio interference in which case the user may be required to take adequate measures.

* The product supports the IEEE802.11 a/b/g/n, Soft-AP communication protocol.
(Samsung recommends IEEE802.11n.)

MIM-H04N / MIM-H04NDZ

Wi-Fi	
Frequency Range	Transmitter Power (Max)
2412 - 2472 MHZ	17 dBm

* The product supports the IEEE802.11 b/g/n, Soft-AP communication protocol.
(Samsung recommends IEEE802.11n.)

Open Source Announcement

The software included in this product contains open source software. You may obtain the complete corresponding source code for a period of three years after the last shipment of this product by sending an email to <mailto:oss.request@samsung.com>.

It is also possible to obtain the complete corresponding source code in a physical medium such as a CD-ROM; a minimal charge will be required.

The following URL http://opensource.samsung.com/opensource/WIFIKIT_R18_TZ4/seq/0 leads to the download page of the source code made available and open source license information as related to this product. This offer is valid to anyone in receipt of this information.



Declaration of Conformity

English	Hereby, Samsung Electronics, declares that the radio equipment type appliance is in compliance with Directive 2014/53/EU. The full text of the EU declaration of conformity is available at the following internet address: The official Declaration of conformity may be found at http://www.samsung.com , go to Support > Search Product Support and enter the model name.
Czech	Společnost Samsung Electronics tímto prohlašuje, že uvedené rádiové zařízení vyhovuje požadavkům směrnice 2014/53/EU. Úplné znění EU Prohlášení o shodě je k dispozici na následující internetové adrese: Oficiální prohlášení o shodě naleznete na webu http://www.samsung.com , kde klepnete na odkaz Podpora a do pole Hledat Podporu zadejte název modelu.
Danish	Samsung Electronics erklærer hermed, at denne type radioudstørsapparat opfylder kravene og bestemmelserne i direktiv 2014/53/EU. Hele teksten i EU-overensstemmelseserklæringen findes på denne webadresse: Den officielle overensstemmelseserklæring kan findes på http://www.samsung.com . Gå til support > Søg efter produktsupport, og angiv modelnavnet.
German	Samsung Electronics erklärt hiermit, dass diese Vorrichtung vom Gerätetyp Funkgerät der Richtlinie 2014/53/EU entspricht. Der gesamte Text der EU-Konformitätserklärung ist unter der folgenden Internetadresse verfügbar: Die offizielle Konformitätserklärung ist unter http://www.samsung.com zu finden. Gehen Sie zu Support > Produktsupport durchsuchen und geben Sie den Modellnamen ein.
Estonian	Käesolevaga kinnitab Samsung Electronics, et raadioseadme tüüpi seade vastab direktiivile 2014/53/EL. EL-i vastavusdeklaratsiooni terve tekst on saadaval internetis järgmisel aadressil. Ametliku vastavusdeklaratsiooni leiate aadressilt http://www.samsung.com , avage menüü Tugi > Otsi toote tuge ja sisestage seejärel mudeli nimi.
Spanish	Por la presente, Samsung Electronics declara que este aparato de equipamiento de radio cumple con la Directiva 2014/53/UE. El texto completo de la declaración de conformidad con la UE está disponible en la siguiente dirección de Internet: La Declaración de conformidad oficial se puede encontrar en http://www.samsung.com , vaya a soporte > Búsqueda de soporte de productos e introduzca el nombre del modelo.
Greek	Με την παρούσα, η Samsung Electronics, δηλώνει ότι η συσκευή ραδιοεξοπλισμού συμμορφώνεται με την Οδηγία 2014/53/ΕΕ. Το πλήρες κείμενο της δήλωσης συμμόρφωσης με την ευρωπαϊκή οδηγία είναι διαθέσιμο στη διεύθυνση: Μπορείτε να βρείτε την επίσημη δήλωση συμμόρφωσης στην τοποθεσία http://www.samsung.com . Επιλέξτε Υποστήριξη > Αναζήτηση υποστήριξης προϊόντος και εισαγάγετε το όνομα μοντέλου.
French	Par la présente, Samsung Electronics déclare que cet appareil de type équipement radio est en conformité avec la Directive 2014/53/UE. Le texte intégral de la déclaration de conformité de l'UE est disponible à l'adresse Internet suivante : La Déclaration officielle de conformité se trouve sur http://www.samsung.com , rendez-vous sur la page d'assistance > Rechercher dans l'Assistance et saisissez un nom de modèle.
Italian	Samsung Electronics dichiara che l'apparecchiatura radio aderisce alla direttiva 2014/53/EU. Il testo integrale della dichiarazione di conformità EU è disponibile al seguente indirizzo: La dichiarazione ufficiale di conformità è disponibile su http://www.samsung.com , selezionare supporto > Cerca Supporto Prodotto e inserire il nome del modello.
Latvian	Samsung Electronics ar šo paziņo, ka šī radioiekārtas tipa ierīce atbilst Direktīvas 2014/53/ES prasībām. Pilns ES atbilstības deklarācijas teksts ir pieejams šajā interneta adresē: Oficiālo atbilstības deklarāciju var atrast vietnē http://www.samsung.com , atverot Atbalsts > Meklēt produkta atbalstu un ievadot modeļa nosaukumu.



Lithuanian	Šiuo dokumentu „Samsung Electronics“ patvirtina, kad radijo įrangos tipo prietaisais atitinka direktyvos 2014/53/ES reikalavimus. Visą ES atitikties deklaracijos tekstą rasite apsilankę internetinėje svetainėje adresu: Oficiali atitikties deklaracija pateikiama svetainėje http://www.samsung.com , eikite į skirtuką Palaikymas > Ieškoti gaminio palaikymo ir įveskite modelio numerį.
Dutch	Samsung Electronics verklaart hierbij dat het type radiotoestel voldoet aan Richtlijn 2014/53/EU. De volledige tekst van de EG-Conformiteitsverklaring vindt u op deze website: De officiële Conformiteitsverklaring vindt u op http://www.samsung.com , ga naar Ondersteuning > Productondersteuning zoeken en voer de modelnaam in.
Hungarian	A Samsung Electronics ezennel kijelenti, hogy a rádiós berendezés típusú készülék megfelel a 2014/53/EK irányelv előírásainak. Az EU megfelelőségi nyilatkozat teljes szövege az alábbi weboldalon olvasható: A hivatalos Megfelelőségi nyilatkozat a http://www.samsung.com honlapon olvasható, lépjen a Támogatás > Terméktámogatás keresése menüpontra, és adja meg a modell nevét.
Polish	Firma Samsung Electronics niniejszym oświadcza, że sprzęt radiowy jest zgodny z wymogami Dyrektywy 2014/53/UE. Pełny tekst europejskiej deklaracji zgodności jest dostępny na stronie internetowej: Treść oficjalnej deklaracji zgodności jest dostępna pod adresem http://www.samsung.com w menu Wsparcie > Szukaj, gdzie należy podać nazwę modelu.
Portuguese	Pelo presente, a Samsung Electronics declara que o aparelho tipo equipamento de rádio está em conformidade com a Diretiva 2014/53/UE. O texto integral da declaração de conformidade europeia está disponível no seguinte endereço da internet: A Declaração de conformidade oficial pode ser encontrada em http://www.samsung.com , vá a Suporte > Pesquisar Suporte do produto e insira o nome do modelo.
Slovenian	S tem družba Samsung Electronics izjavlja, da je radijska oprema skladna z Direktivo 2014/53/EU. Celotno besedilo izjave ES o skladnosti je na voljo na spodnjem internetnem naslovu: Uradno izjavo o skladnosti lahko najdete na naslovu http://www.samsung.com . Pojdite na podpora > Iskanje podpore za izdelek, nato vnesite ime izdelka.
Slovak	Spoločnosť Samsung Electronics týmto vyhlasuje, že zariadenie rádiového typu je v súlade so smernicou 2014/53/EÚ. Celé znenie Vyhlásenia o zhode EÚ je k dispozícii na nasledujúcej internetovej adrese: Oficiálne Vyhlásenie o zhode sa nachádza na lokalite http://www.samsung.com , prejdite na položky Podpora > Vyhládavanie podpory produktov a zadajte názov modelu.
Finnish	Samsung Electronics vakuuttaa, että radiolaitte on direktiivin 2014/53/EU vaatimusten mukainen. EU-vaatimustenmukaisuusvakuutuksen täydellinen teksti on saatavilla seuraavassa Internet-osoitteessa: Virallinen vaatimustenmukaisuusvakuutus on osoitteessa http://www.samsung.com . Valitse Tuki > Etsi tuotetukea ja kirjoita mallinimi.
Swedish	Härmed deklarerar Samsung Electronics att denna anordning av radioutrustningstyp uppfyller direktivet 2014/53/EU. Den fullständiga texten i EU-deklarationen om överensstämmelse finns tillgänglig på följande internetadress: Den officiella deklarationen om överensstämmelse finns på http://www.samsung.com . Gå till stöd > Sök produktsupport och ange modellnamnet.
Bulgarian	С настоящия документ Samsung Electronics декларира, че уредът от тип радиооборудване е в съответствие с Директива 2014/53/ЕС. Целият текст на ЕС Декларацията за съответствие е наличен на следния интернет адрес: Официалната Декларация за съответствие можете да намерите на http://www.samsung.com , отидете на отидете на поддръжка > Търсене на поддръжка за продукт и въведете името на модела.
Romanian	Prin prezenta, Samsung Electronics declară faptul că aparatul de tip echipament radio respectă Directiva 2014/53/UE. Textul complet al declarației de conformitate UE este disponibil la una dintre următoarele adrese de internet: Declarația de conformitate oficială poate fi găsită la http://www.samsung.com , accesați asistența > Căutați asistența produsului și introduceți numele modelului.



Declaration of Conformity

Norwegian	Samsung Electronics erklærer herved at dette radioutstyret er i samsvar med direktiv 2014/53/EU. Den fullstendige teksten til EU-samsvarserklæringen er tilgjengelig på følgende nettadresse: Den offisielle samsvarserklæringen finnes på http://www.samsung.com . Gå til Support > Søk gjennom produktsupport og angi modellnavn.
Turkish	İşbu belge ile, Samsung Electronics bu radyo ekipmanı türü cihazın 2014/53/EU Direktifine uygun olduğunu beyan etmektedir. AB uygunluk beyanının tam metnine aşağıdaki internet adresinden ulaşabilirsiniz: Resmî Uygunluk beyanını http://www.samsung.com adresinde bulabilirsiniz. Destek > Ürün Desteği Ara'ya gidin ve model adını girin.
Russian	Настоящим компания Samsung Electronics заявляет, что устройство типа "радиооборудование" соответствует Директиве 2014/53/ЕС. Полный текст декларации о соответствии ЕС доступен по следующему веб-адресу: Официальная Декларация о соответствии доступна по адресу http://www.samsung.com , перейдите в раздел Поддержка > Поиск продукта и введите имя модели.
Ukrainian	Цим компанія Samsung Electronics заявляє, що прилад, який належить до радіобладнання, відповідає вимогам Директиви 2014/53/EU. Повний текст декларації про відповідність нормам країн ЄС доступний за такою адресою в інтернеті: Офіційний текст Декларації про відповідність можна знайти на сайті http://www.samsung.com ; перейдіть до розділу підтримки, потім — до поля пошуку підтримки для певного виробу та введіть назву моделі.
Serbian	Ovim putem kompanija Samsung Electronics izjavljuje da je ovaj uređaj u tipu radio opreme u skladu sa direktivom 2014/53/EU. Kompletan sadržaj EU deklaracije o usaglašenosti dostupan je na sledećoj internet adresi: Zvaničnu deklaraciju o usaglašenosti možete naći na adresi http://www.samsung.com , idite na Podrška > Pretraga podrške za proizvode i unesite naziv modela.
Croatian	Tvrtka Samsung Electronics ovim izjavljuje da je uređaj tipa radijske opreme usklađen s Direktivom 2014/53/EU. Potpuni tekst EU deklaracije o sukladnosti dostupan je na sljedećim web-adresama: Službenu Izjavu o sukladnosti možete pronaći na adresi http://www.samsung.com , ako odaberete Podrška > Traži podršku za proizvod i unesete naziv modela.

Caution about 5GHz range radio equipment

English	"The 5 GHz WLAN function of this equipment may only be operated indoors. This equipment may be operated in all EU countries."
Czech	"Funkci sítě WLAN v pásmu 5 GHz tohoto zařízení je možné používat pouze v interiérech. Toto zařízení může být provozováno ve všech zemích EU."
Danish	"5 GHz WLAN-funktionen i dette udstyr må kun anvendes indendørs. Dette udstyr kan anvendes i alle EU-lande."
German	"Die 5 GHz-WLAN-Funktion dieses Geräts kann nur in Innenräumen betrieben werden. Dieses Gerät kann in allen EU-Ländern betrieben werden."
Estonian	"Selle seadme 5 GHz WLAN-i funktsiooni võib kasutada ainult siseruumides. Seda seadet võib kasutada kõikides EL-i riikides."
Spanish	"La función WLAN de 5 GHz de este equipo solo puede utilizarse en interiores. Este equipo es apto para el funcionamiento en todos los países de la Unión Europea."
Greek	"Η λειτουργία WLAN 5 GHz του παρόντος εξοπλισμού μπορεί να χρησιμοποιηθεί μόνο σε εσωτερικό χώρο. Ο παρών εξοπλισμός μπορεί να λειτουργήσει σε όλες τις χώρες της ΕΕ."



French	"La fonction WLAN 5 GHz de cet équipement ne peut être utilisée qu'à l'intérieur. Cet équipement peut fonctionner dans tous les pays de l'Union européenne."
Italian	"La funzione 5 GHz WLAN di questo apparecchio può essere utilizzata solo in ambienti interni. Questo apparecchio è adatto all'uso in tutti i paesi dell'UE."
Latvian	"Šī aprīkojuma 5 GHz WLAN funkciju var lietot tikai iekšējās. Šo aprīkojumu var lietot visās ES valstīs."
Lithuanian	"Šios įrangos 5 GHz WLAN funkcija gali būti naudojama tik patalpose. Galite šią įrangą naudoti visose ES šalyse."
Dutch	"De 5 GHz WLAN-functie van deze apparatuur mag alleen binnenshuis worden gebruikt. Dit apparaat mag worden gebruikt in alle landen in de EU."
Hungarian	"A készülék 5 GHz-es WLAN funkcióját csak beltéren lehet üzemeltetni. Ez a berendezés az EU összes országában működtethető."
Polish	"Z funkcji 5 GHz WLAN tego urządzenia można korzystać wyłącznie wewnątrz budynków. Z tego urządzenia można korzystać we wszystkich krajach Unii Europejskiej."
Portuguese	"A função WLAN de 5 GHz deste equipamento só pode ser utilizada num espaço interior. Este equipamento pode ser utilizado em todos os países da UE."
Slovenian	"Funkcija WLAN (5 GHz) te opreme se lahko uporablja samo v notranjih prostorih. To opremo se lahko uporablja v vseh državah EU."
Slovak	"Funkcia 5 GHz bezdrôtovej siete LAN (WLAN) tohto zariadenia smie byť prevádzkovaná len v interiéroch. Toto zariadenie smie byť prevádzkované vo všetkých krajinách EÚ."
Finnish	"Tämän laitteen 5 GHz:n WLAN-toimintoa saa käyttää ainoastaan sisätiloissa. Tätä laitetta saa käyttää kaikissa EU-maissa."
Swedish	"Utrustningens 5 GHz WLAN-funktion får bara användas inomhus. Det är tillåtet att använda utrustningen i alla EU-länder."
Bulgarian	"5 GHz WLAN функцията на това оборудване може да се използва само на закрито. Това оборудване може да се използва във всички държави от ЕС."
Romanian	"Funcția 5 GHz WLAN a acestui echipament poate fi utilizată numai în spații interioare. Acest echipament poate fi utilizat în toate țările UE."
Norwegian	"5 GHz WLAN-funksjonen for dette utstyret kan bare brukes innendørs. Dette utstyret kan brukes i alle EU-land."
Turkish	Bu ekipmanın 5 GHz WLAN özelliği sadece kapalı alanlarda kullanılabilir. Bu ekipman tüm AB ülkelerinde kullanılabilir.
Russian	"Функцию WLAN 5 ГГц данного оборудования можно использовать только в помещении. Данное оборудование может использоваться во всех странах ЕС."
Ukrainian	"Функцію бездротової локальної мережі WLAN 5 ГГц цього обладнання можна використовувати лише в приміщенні. Це обладнання можна використовувати в усіх країнах ЕС."
Serbian	"Funkcija ove opreme za mrežu WLAN od 5 GHz može da se koristi samo u zatvorenom prostoru. Ova oprema može da se koristi u svim zemljama EU."
Croatian	"Funkcija ovog uređaja za mrežu WLAN od 5 GHz može se upotrebljavati samo u zatvorenom prostoru. Ovaj uređaj može se upotrebljavati u svim državama EU-a."





SAMSUNG

Declaration of Conformity

Manufacturer

Samsung Electronics Co., Ltd.

Product details

Product :	Wifi-Kit accessory for air-conditioner & heat pump
Model(s) :	MIM-H04N
Variet Model(s) :	MIM-H04, MIM-H04NDZ

Declaration & Applicable standards

We hereby declare, that the product above is in compliance with the essential requirements of the Radio Equipment Directive (2014/53/EU) by application of

EMC

EN 301 489-1 V2.1.1
EN 301 489-17 V3.1.1
EN 55032:2015
EN 55035:2017

Safety

EN 60950-1:2006 +A11:2009 +A1:2010 +A12:2011+A2:2013
EN 62311:2008

Radio

EN 300 328 V2.1.1

and the Directive (2011/65/EU) on the restriction of the use of certain hazardous substances in electrical and electronic equipment by application of EN 50581:2012.

Signed on behalf of Samsung

Samsung Electronics QA Lab.
Blackbushe Business Park
Saxony Way, Yateley, Hampshire
GU46 6GG, UK

2019-03-12

(Place and date of issue)

Stephen Colclough – Director Regulatory Affairs

(Name and signature of authorized person)

※ This is not the address of Samsung Service Centre. Please see the address or the phone number of Samsung Service Centre in the warranty card or contact the retailer where you purchased your product.





SAMSUNG

Declaration of Conformity

Manufacturer

Samsung Electronics Co., Ltd.

Product details

Product :	Wifi-Kit accessory for air-conditioner & heat pump
Model(s) :	MIM-H04EN
Variant Model(s) :	MIM-H04E, MIM-H04RN

Declaration & Applicable standards

We hereby declare, that the product above is in compliance with the essential requirements of the Radio Equipment Directive (2014/53/EU) by application of

EMC

EN 301 489-1 V2.1.1
EN 301 489-17 V3.1.1
EN 55032:2015
EN 55035:2017

Safety

EN 60950-1:2006 +A11:2009 +A1:2010 +A12:2011+A2:2013
EN 62311:2008

Radio

EN 300 893 V2.1.1
EN 300 328 V2.1.1

and the Directive (2011/65/EU) on the restriction of the use of certain hazardous substances in electrical and electronic equipment by application of EN 50581:2012.

Signed on behalf of Samsung

Samsung Electronics QA Lab.
Blackbushe Business Park
Saxony Way, Yateley, Hampshire
GU46 6GG, UK

2019-04-26

(Place and date of issue)

Stephen Colclough – Director Regulatory Affairs

(Name and signature of authorized person)

※ This is not the address of Samsung Service Centre. Please see the address or the phone number of Samsung Service Centre in the warranty card or contact the retailer where you purchased your product.





SAMSUNG

